

# ATOMIC STRUCTURE AND THE PERIODIC TABLE

## Preface

The structure of the atom is extensively covered here. The periodic table is the arrangement of atoms of elements based on their atomic structure. Emphasis on the trends across and down the periodic table of atoms is important for the teacher facilitator. This work should be covered before “**Chemical bonding and structure**”. The two complements each other in understanding **periodicity**. Candidate-user preparing for any secondary level chemistry from members of

## A. ATOMIC STRUCTURE

The atom is the smallest particle of an element that take part in a chemical reaction. The atom is made up of three subatomic particle:

- (i) Protons
- (ii) Electrons
- (iii) Neutrons

### (i) Protons

1. The proton is positively charged
2. Is found in the centre of an atom called nucleus
3. It has a relative mass 1
4. The number of protons in a atom of an element is its Atomic number

### (ii) Electrons

1. The Electrons is negatively charged
2. Is found in fixed regions surrounding the centre of an atom called energy levels/orbitals.
3. It has a relative mass  $\frac{1}{1840}$
4. The number of protons and electrons in a atom of an element is always equal

### (iii) Neutrons

1. The Neutron is neither positively or negatively charged thus neutral.
2. Like protons it is found in the centre of an atom called nucleus
3. It has a relative mass 1
4. The number of protons and neutrons in a atom of an element is its Mass number

**Diagram showing the relative positions of protons ,electrons and neutrons in an atom of an element**

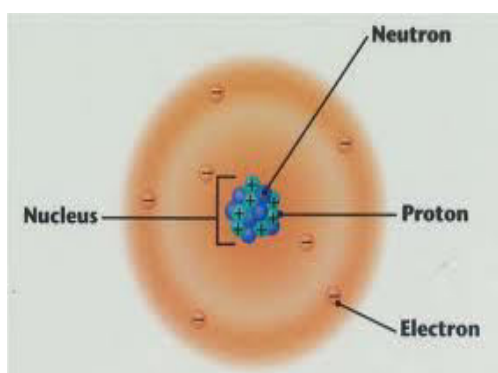

**Diagram showing the relative positions of protons, electrons and neutrons in an atom of Carbon**

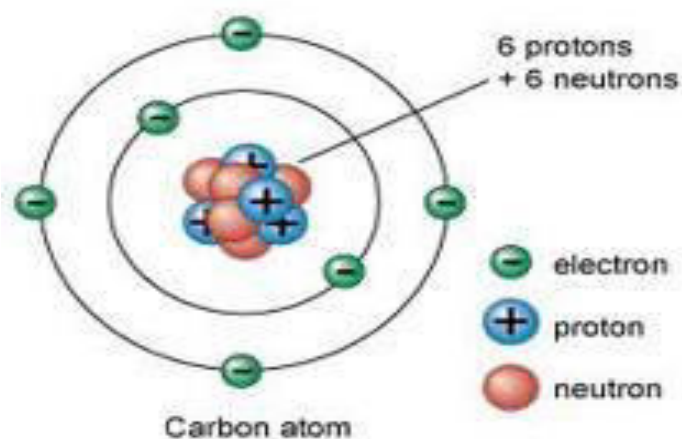

The table below show atomic structure of the 1<sup>st</sup> twenty elements.

Element	Symbol	Protons	Electrons	Neutrons	Atomic number	Mass number
Hydrogen	H	1	1	0	1	1
Helium	He	2	2	2	2	4
Lithium	Li	3	3	4	3	7
Beryllium	Be	4	4	5	4	9
Boron	B	5	5	6	5	11
Carbon	C	6	6	6	6	12
Nitrogen	N	7	7	7	7	14
Oxygen	O	8	8	8	8	16
Fluorine	F	9	9	10	9	19
Neon	Ne	10	10	10	10	20

Sodium	<b>Na</b>	<b>11</b>	<b>11</b>	<b>12</b>	<b>11</b>	<b>23</b>
Magnesium	<b>Mg</b>	<b>12</b>	<b>12</b>	<b>12</b>	<b>12</b>	<b>24</b>
Aluminium	<b>Al</b>	<b>13</b>	<b>13</b>	<b>14</b>	<b>13</b>	<b>27</b>
Silicon	<b>Si</b>	<b>14</b>	<b>14</b>	<b>14</b>	<b>14</b>	<b>28</b>
Phosphorus	<b>P</b>	<b>15</b>	<b>15</b>	<b>16</b>	<b>15</b>	<b>31</b>
Sulphur	<b>S</b>	<b>16</b>	<b>16</b>	<b>16</b>	<b>16</b>	<b>32</b>
Chlorine	<b>Cl</b>	<b>17</b>	<b>17</b>	<b>18</b>	<b>17</b>	<b>35</b>
Argon	<b>Ar</b>	<b>18</b>	<b>18</b>	<b>22</b>	<b>18</b>	<b>40</b>
Potassium	<b>K</b>	<b>19</b>	<b>19</b>	<b>20</b>	<b>19</b>	<b>39</b>
Calcium	<b>Ca</b>	<b>20</b>	<b>20</b>	<b>20</b>	<b>20</b>	<b>40</b>

Most atoms of elements exist as **isotopes**.

Isotopes are atoms of the same **element**, having the same number of **protons**/atomic number but **different** number of **neutrons**/mass number.

By convention, isotopes are written with the mass number as superscript and the atomic number as subscript to the left of the chemical symbol of the element.

i.e.

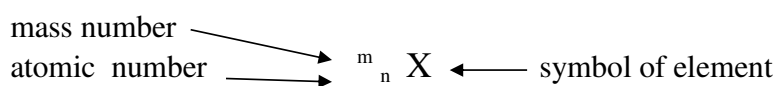

Below is the conventional method of writing the 1<sup>st</sup> twenty elements showing the mass numbers and atomic numbers;

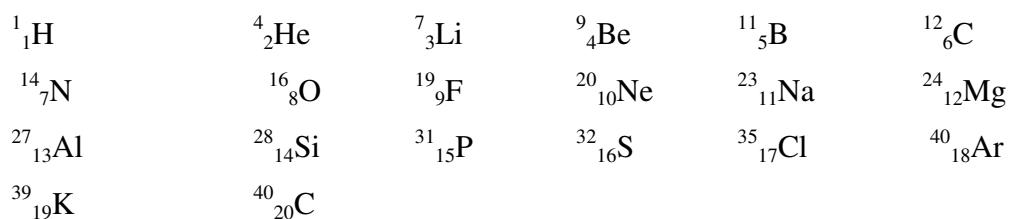

The table below shows some common **natural** isotopes of some elements

Element	Isotopes	Protons	Electrons	Neutrons	Atomic number	Mass number
Hydrogen	${}^1_1\text{H}$	1	1	0	1	1
	${}^2_1\text{H}$ (deuterium)	1	1	2	1	2
	${}^3_1\text{H}$ (Tritium)	1	1	3	1	3
Chlorine	${}^{35}_{17}\text{Cl}$	17	17	18	17	35
	${}^{37}_{17}\text{Cl}$	17	17	20	17	37
Potassium	${}^{39}_{19}\text{K}$	19	19	20	19	39
	${}^{40}_{19}\text{K}$	19	19	21	19	40

	$^{41}_{19}\text{K}$	19	19	22	19	41
Oxygen	$^{16}_8\text{O}$	8	8	8	8	16
	$^{18}_8\text{O}$	8	8	10	8	18
Uranium	$^{235}_{92}\text{U}$	92	92	143	92	235
	$^{238}_{92}\text{U}$	92	92	146	92	238
Neon	$^{22}_{10}\text{Ne}$	10	10	12	10	22
	$^{20}_{10}\text{Ne}$	10	10	10	10	20
	$^{21}_{10}\text{Ne}$	10	10	11	10	21

The mass of an average atom is very small ( $10^{-22}$  g). Masses of atoms are therefore expressed in relation to a chosen element.

The atom recommended is  $^{12}\text{C}$  isotope whose mass is arbitrarily assigned as 12.000 atomic mass units (a.m.u).

All other atoms are compared to the mass of  $^{12}\text{C}$  isotope to give the **relative atomic mass (RAM)** is therefore defined as “**the mass of average atom of an element compared to  $^{12}\text{C}$  isotope whose mass is arbitrarily fixed as 12.000 atomic mass units (a.m.u)**” i.e;

$$\text{RAM} = \frac{\text{mass of atom of an element}}{\frac{1}{12} \text{ of one atom of } ^{12}\text{C} \text{ isotope}}$$

Accurate relative atomic masses (RAM) are got from the **mass spectrometer**. Mass spectrometer determines the **isotopes** of the element and their relative **abundance/availability**.

Using the relative abundances/availability of the isotopes, the relative atomic mass (RAM) can be determined/calculated as in the below examples.

- a) Chlorine occurs as 75%  $^{35}_{17}\text{Cl}$  and 25%  $^{37}_{17}\text{Cl}$  isotopes. Calculate the relative atomic mass of Chlorine.

Working

100 atoms of chlorine contains 75 atoms of  $^{35}_{17}\text{Cl}$  isotopes

100 atoms of chlorine contains 25 atoms of  $^{37}_{17}\text{Cl}$  isotopes

Therefore;

$$\text{RAM of chlorine} = (75/100 \times 35) + 25/100 \times 37 = \mathbf{35.5}$$

Note that:

**Relative atomic mass has no units**

**More atoms of chlorine exist as  $^{35}_{17}\text{Cl}$  (75%) than as  $^{37}_{17}\text{Cl}$  (25%) therefore RAM is nearer to the more abundant isotope.**

- b) Calculate the relative atomic mass of potassium given that it exist as;

93.1%  $^{39}_{19}\text{K}$ , 0.01%  $^{40}_{19}\text{K}$ , 6.89%  $^{41}_{19}\text{K}$ ,

Working

100 atoms of potassium contains 93.1 atoms of  $^{39}_{19}\text{K}$  isotopes

100 atoms of potassium contains 0.01 atoms of  $^{40}_{19}\text{K}$  isotopes

100 atoms of potassium contains 6.89 atoms of  $^{41}_{19}\text{K}$  isotopes

Therefore;

$$\text{RAM of potassium} = (93.1/100 \times 39) + (0.01/100 \times 40) + (6.89/100 \times 39)$$

$$=$$

Note that:

**Relative atomic mass has no units**

**More atoms of potassium exist as  $^{39}_{19}\text{K}$  (93.1%) therefore RAM is nearer to the more abundant  $^{39}_{19}\text{K}$  isotope.**

- c) Calculate the relative atomic mass of Neon given that it exist as;

90.92%  $^{20}_{10}\text{Ne}$ , 0.26%  $^{21}_{10}\text{Ne}$ , 8.82%  $^{22}_{10}\text{Ne}$ ,

Working

100 atoms of Neon contains 90.92 atoms of  $^{20}_{10}\text{Ne}$  isotopes

100 atoms of Neon contains 0.26 atoms of  $^{21}_{10}\text{Ne}$  isotopes

100 atoms of Neon contains 8.82 atoms of  $^{22}_{10}\text{Ne}$  isotopes

Therefore;

$$\text{RAM of Neon} = (90.92/100 \times 20) + (0.26/100 \times 21) + (8.82/100 \times 22)$$

$$=$$

Note that:

**Relative atomic mass has no units**

**More atoms of Neon exist as  $^{20}_{10}\text{Ne}$  (90.92%) therefore RAM is nearer to the more abundant  $^{20}_{10}\text{Ne}$  isotope.**

- d) Calculate the relative atomic mass of Argon given that it exist as;

90.92%  $^{20}_{10}\text{Ne}$ , 0.26%  $^{21}_{10}\text{Ne}$ , 8.82%  $^{22}_{10}\text{Ne}$ ,

NB

The relative atomic mass is a measure of the masses of atoms. The higher the relative atomic mass, the heavier the atom.

Electrons are found in **energy levels/orbital**.

An energy level is a **fixed region** around/surrounding the nucleus of an atom occupied by electrons of the **same (potential) energy**.

**By convention** energy levels are named 1,2,3... **outwards** from the region **nearest** to nucleus.

Each energy level is occupied by a fixed number of electrons:

The **1<sup>st</sup>** energy level is occupied by a maximum of **two** electrons

The **2<sup>nd</sup>** energy level is occupied by a maximum of **eight** electrons  
 The **3<sup>rd</sup>** energy level is occupied by a maximum of **eight** electrons( or **eighteen** electrons if available)  
 The **4<sup>th</sup>** energy level is occupied by a maximum of **eight** electrons( or **eighteen or thirty two** electrons if available)

This arrangement of electrons in an atom is called **electron configuration / structure**.

**By convention** the electron configuration / structure of an atom of an element can be shown in form of a diagram using either cross(x) or dot(●) to

### Practice examples drawing electronic configurations

a)  ${}^1_1\text{H}$  has - in nucleus **1**proton and **0** neutrons  
 - 1 electron in the 1<sup>st</sup> energy levels thus:

Nucleus

Energy levels

Electrons(represented by cross(x))

Electronic structure of Hydrogen is thus: **1:**

b)  ${}^4_2\text{He}$  has - in nucleus **2** proton and **2** neutrons  
 - 2 electron in the 1<sup>st</sup> energy levels thus:

Nucleus

Energy levels

Electrons (represented by cross(x))

Electronic structure of Helium is thus: **2:**

c)  ${}^7_3\text{Li}$  has - in nucleus **3** proton and **4** neutrons  
 - **2** electron in the 1<sup>st</sup> energy levels  
 -**1** electron in the 2<sup>nd</sup> energy levels thus

Nucleus

Energy levels

Electrons (represented by cross(x))

Electronic structure of Lithium is thus: **2:1**

Kommentar [s1]:

- d)  ${}^9_4\text{Be}$  has - in nucleus **4** proton and **5** neutrons  
 - **2** electron in the 1<sup>st</sup> energy levels  
 -**2** electron in the 2<sup>nd</sup> energy levels thus

Nucleus  
 Energy levels  
 Electrons (represented by cross(x))

Electronic structure of Beryllium is thus: **2:2**

- e)  ${}^{11}_5\text{B}$  has - in nucleus **5** proton and **6** neutrons  
 - **2** electron in the 1<sup>st</sup> energy levels  
 -**3** electron in the 2<sup>nd</sup> energy levels thus

Nucleus  
 Energy levels  
 Electrons (represented by cross(x))

Electronic structure of Boron is thus: **2:3**

- f)  ${}^{12}_6\text{C}$  has - in nucleus **6** proton and **6** neutrons  
 - **2** electron in the 1<sup>st</sup> energy levels  
 -**4** electron in the 2<sup>nd</sup> energy levels thus

Nucleus  
 Energy levels  
 Electrons (represented by cross(x))

Electronic structure of Carbon is thus: **2:4**

- g)  ${}^{14}_7\text{N}$  has - in nucleus **7** proton and **7** neutrons  
 - **2** electron in the 1<sup>st</sup> energy levels  
 -**5** electron in the 2<sup>nd</sup> energy levels thus

Nucleus  
 Energy levels  
 Electrons (represented by cross(x))

Electronic structure of Nitrogen is thus: **2:5**

- h)  $^{16}_8\text{O}$  has
- in nucleus **8** proton and **8** neutrons
  - **2** electron in the 1<sup>st</sup> energy levels
  - **6** electron in the 2<sup>nd</sup> energy levels thus

Nucleus

Energy levels

Electrons (represented by cross(x))

Electronic structure of Oxygen is thus: **2:6**

- i)  $^{19}_9\text{F}$  has
- in nucleus **9** proton and **10** neutrons
  - **2** electron in the 1<sup>st</sup> energy levels
  - **7** electron in the 2<sup>nd</sup> energy levels thus

Nucleus

Energy levels

Electrons (represented by cross(x))

Electronic structure of Fluorine is thus: **2:7**

- i)  $^{20}_{10}\text{Ne}$  has
- in nucleus **10** proton and **10** neutrons
  - **2** electron in the 1<sup>st</sup> energy levels
  - **8** electron in the 2<sup>nd</sup> energy levels thus

Nucleus

Energy levels

Electrons (represented by cross(x))

Electronic structure of Neon is thus: **2:8**

- j)  $^{23}_{11}\text{Na}$  has
- in nucleus **11** proton and **12** neutrons
  - **2** electron in the 1<sup>st</sup> energy levels
  - **8** electron in the 2<sup>nd</sup> energy levels



-1 electron in the 3<sup>rd</sup> energy levels thus

Nucleus

Energy levels

Electrons (represented by dot(.))

Electronic structure of Sodium is thus: **2:8:1**

k)  $^{24}_{12}\text{Mg}$  has - in nucleus **12** proton and **12** neutrons  
 - **2** electron in the 1<sup>st</sup> energy levels  
 - **8** electron in the 2<sup>nd</sup> energy levels  
 - **2** electron in the 3<sup>rd</sup> energy levels thus

Nucleus

Energy levels

Electrons (represented by dot(.))

Electronic structure of Magnesium is thus: **2:8:2**

l)  $^{27}_{13}\text{Al}$  has - in nucleus **13** proton and **14** neutrons  
 - **2** electron in the 1<sup>st</sup> energy levels  
 - **8** electron in the 2<sup>nd</sup> energy levels  
 - **3** electron in the 3<sup>rd</sup> energy levels thus

Nucleus

Energy levels

Electrons (represented by dot(.))

Electronic structure of Aluminium is thus: **2:8:3**

m)  $^{28}_{14}\text{Si}$  has - in nucleus **14** proton and **14** neutrons  
 - **2** electron in the 1<sup>st</sup> energy levels  
 - **8** electron in the 2<sup>nd</sup> energy levels  
 - **4** electron in the 3<sup>rd</sup> energy levels thus

Nucleus

Energy levels

Electrons (represented by dot(.))

Electronic structure of Silicon is thus: **2:8:4**

- n)  $^{31}_{15}\text{P}$  has - in nucleus **14** proton and **15** neutrons  
 - **2** electron in the 1<sup>st</sup> energy levels  
 - **8** electron in the 2<sup>nd</sup> energy levels  
 - **5** electron in the 3<sup>rd</sup> energy levels thus

Nucleus

Energy levels

Electrons (represented by dot(.))

Electronic structure of Phosphorus is thus: **2:8:5**

- o)  $^{32}_{16}\text{S}$  has - in nucleus **16** proton and **16** neutrons  
 - **2** electron in the 1<sup>st</sup> energy levels  
 - **8** electron in the 2<sup>nd</sup> energy levels  
 - **6** electron in the 3<sup>rd</sup> energy levels thus

Nucleus

Energy levels

Electrons (represented by dot(.))

Electronic structure of Sulphur is thus: **2:8:6**

- p)  $^{35}_{17}\text{Cl}$  has - in nucleus **18** proton and **17** neutrons  
 - **2** electron in the 1<sup>st</sup> energy levels  
 - **8** electron in the 2<sup>nd</sup> energy levels  
 - **7** electron in the 3<sup>rd</sup> energy levels thus

Nucleus

Energy levels

Electrons (represented by dot(.))

Electronic structure of Chlorine is thus: **2:8:7**

- p)  $^{40}_{18}\text{Ar}$  has - in nucleus **22** proton and **18** neutrons  
 - **2** electron in the 1<sup>st</sup> energy levels  
 - **8** electron in the 2<sup>nd</sup> energy levels  
 - **8** electron in the 3<sup>rd</sup> energy levels thus

Nucleus

Energy levels

Electrons (represented by dot(.))

Electronic structure of Argon is thus: **2:8:8**

- q)  ${}^{39}_{19}\text{K}$  has - in nucleus **20** proton and **19** neutrons
- **2** electron in the 1<sup>st</sup> energy levels
  - **8** electron in the 2<sup>nd</sup> energy levels
  - **8** electron in the 3<sup>rd</sup> energy levels
  - **1** electron in the 4<sup>th</sup> energy levels thus

Nucleus

Energy levels

Electrons (represented by dot(.))

Electronic structure of Potassium is thus: **2:8:8:1**

- r)  ${}^{40}_{20}\text{Ca}$  has - in nucleus **20** proton and **20** neutrons
- **2** electron in the 1<sup>st</sup> energy levels
  - **8** electron in the 2<sup>nd</sup> energy levels
  - **8** electron in the 3<sup>rd</sup> energy levels
  - **2** electron in the 4<sup>th</sup> energy levels thus

Nucleus

Energy levels

Electrons (represented by dot(.))

Electronic structure of Calcium is thus: **2:8:8:2**

## **B.PERIODIC TABLE**

There are over 100 elements so far discovered. Scientists have tried to group them together in a periodic table.

A periodic table is a horizontal and vertical arrangement of elements according to their atomic numbers.

This table was successfully arranged in 1913 by the British scientist Henry Moseley from the previous work of the Russian Scientist Dmitri Mendeleev.

The horizontal arrangement forms **period**. Atoms in the same period have the same the same number of energy levels in their electronic structure. i.e.

The number of **energy levels** in the electronic configuration of an element determine the **period** to which the element is in the periodic table.

e.g.

Which period of the periodic table are the following isotopes/elements/atoms?

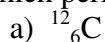

Electron structure 2:4 => 2 energy levels used thus **Period 2**

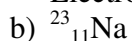

Electron structure 2:8:1 => 3 energy levels used thus **Period 3**

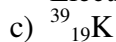

Electron structure 2:8:8:1 => 4 energy levels used thus **Period 4**



Electron structure 1: => 1 energy level used thus **Period 1**

The vertical arrangement of elements forms a **group**. Atoms in the same have the same the same group have the same number of outer energy level electrons as per their electronic structure. i.e.

The number of electrons in the outer energy level an element determine the **group** to which the element is ,in the periodic table.

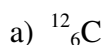

Electron structure 2:4  $\Rightarrow$  4 electrons in outer energy level thus **Group IV**

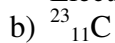

Electron structure 2:8:1  $\Rightarrow$  1 electron in outer energy level thus **Group I**

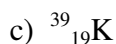

Electron structure 2:8:8:1  $\Rightarrow$  1 electron in outer energy level thus **Group I**



Electron structure 1:  $\Rightarrow$  1 electron in outer energy level thus **Group I**

By convention;

(i) **Periods** are named using English numerals **1,2,3,4,...**

(ii) **Groups** are named using Roman numerals **I,II,III,IV,...**

There are eighteen groups in a standard periodic table.

There are seven periods in a standard periodic table.

**THE STANDARD PERIODIC TABLE OF ELEMENTS**

<b>s Block 1</b>													<b>p Block</b>					<b>18</b>								
1	1											13	14	15	16	17	2									
	H											B	C	N	O	F	He									
2	3	4											5	6	7	8	9	10								
	Li	Be											B	C	N	O	F	Ne								
3	11	12	3	4	5	6	7	8	9	10	11	12	13	14	15	16	17	18								
	Na	Mg											Al	Si	P	S	Cl	Ar								
4	19	20	21	22	23	24	25	26	27	28	29	30	31	32	33	34	35	36								
	K	Ca	Sc	Ti	V	Cr	Mn	Fe	Co	Ni	Cu	Zn	Ga	Ge	As	Se	Br	Kr								
5	37	38	39	40	41	42	43	44	45	46	47	48	49	50	51	52	53	54								
	Rb	Sr	Y	Zr	Nb	Mo	Tc	Ru	Rh	Pd	Ag	Cd	In	Sn	Sb	Te	I	Xe								
6	55	56	57	72	73	74	75	76	77	78	79	80	81	82	83	84	85	86								
	Cs	Ba	La	Hf	Ta	W	Re	Os	Ir	Pt	Au	Hg	Tl	Pb	Bi	Po	At	Rn								
7	87	88	89	104	105	106	107	108	109	110	111	112	113	114	115	116	117	118								
	Fr	Ra	Ac	Rf	Db	Sg	Bh	Hs	Mt	Uun	Uuu	Uub		Uuq		Uuh		Uuo								
<b>KEY - ELEMENTS TYPES</b>													<b>f Block</b>													
<ul style="list-style-type: none"> <li><span style="display: inline-block; width: 10px; height: 10px; background-color: yellow; border: 1px solid black;"></span> Alkali Metals</li> <li><span style="display: inline-block; width: 10px; height: 10px; background-color: orange; border: 1px solid black;"></span> Alkaline earth metals</li> <li><span style="display: inline-block; width: 10px; height: 10px; background-color: lightblue; border: 1px solid black;"></span> Transition Metals</li> <li><span style="display: inline-block; width: 10px; height: 10px; background-color: lightgreen; border: 1px solid black;"></span> Lanthanides rare earth</li> <li><span style="display: inline-block; width: 10px; height: 10px; background-color: purple; border: 1px solid black;"></span> Actinides</li> </ul>													58	59	60	61	62	63	64	65	66	67	68	69	70	71
													Ce	Pr	Nd	Pm	Sm	Eu	Gd	Tb	Dy	Ho	Er	Tm	Yb	Lu
													90	91	92	93	94	95	96	97	98	99	100	101	102	103
													Th	Pa	U	Np	Pu	Am	Cm	Bk	Cf	Es	Fm	Md	No	Lr
													<b>Poor Metals</b>													
													<b>Nonmetals</b>													
													<b>Semimetals</b>													
													<b>Noble Gases</b>													

When an atom has maximum number of electrons in its outer energy level, it is said to be **stable**.

When an atom has no maximum number of electrons in its outer energy level, it is said to be **unstable**.

All stable atoms are in group **8/18** of the periodic table. All other elements are unstable.

All unstable atoms/isotopes try to be stable through chemical reactions. A chemical reaction involves gaining or losing outer electrons (electron transfer). When electron transfer takes place, an ion is formed.

An ion is formed when an unstable atom gains or donates electrons in its outer energy level in order to be stable. Whether an atom gains or donates electrons depends on the relative energy required to donate or gain extra electrons, i.e.

#### Examples

1.  $^{19}_9\text{F}$  has electronic structure/configuration 2:7.

It can donate the seven outer electrons to have stable electronic structure/configuration 2:.

It can gain one extra electron to have stable electronic structure/configuration 2:8. Gaining requires less energy, and thus Fluorine reacts by gaining one extra electron.

2.  $^{23}_{13}\text{Al}$  has electronic structure/configuration 2:8:3

It can donate the three outer electrons to have stable electronic structure/configuration 2:8.

It can gain five extra electrons to have stable electronic structure/configuration 2:8:8. Donating requires less energy, and thus Aluminium reacts by donating its three outer electrons.

Elements with **less** than four electrons in the outer energy level donate/lose the outer electrons to be stable and form a positively charged ion called **cation**. A cation therefore has more protons (positive charge) than electrons (negative charge).

Generally metals usually form cation

Elements with **more** than four electrons in the outer energy level gain/acquire extra electrons in the outer energy level to be stable and form a negatively charged ion called **anion**.

An anion therefore has less protons (positive charge) than electrons (negative charge)

Generally non-metals usually form anion. Except Hydrogen

The charge carried by an ion is equal to the number of electrons gained/acquired or donated/lost.

#### Examples of ion formation

1.  $^1_1\text{H}$

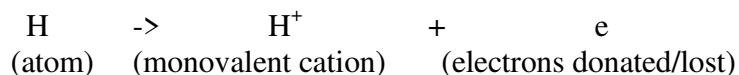

Electronic configuration 1:                      (No electrons remains)

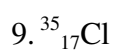
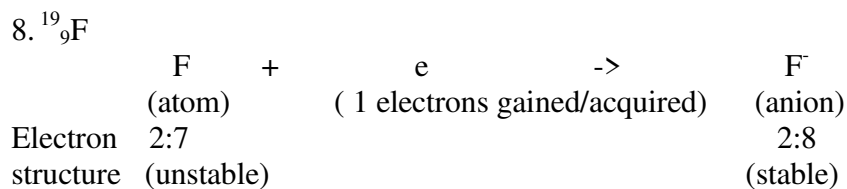
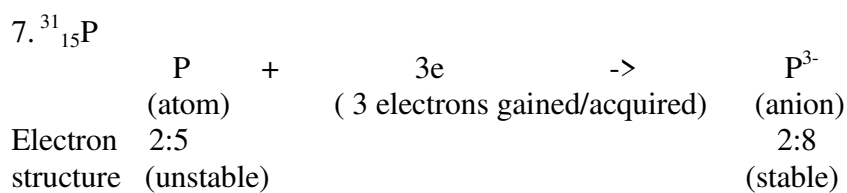
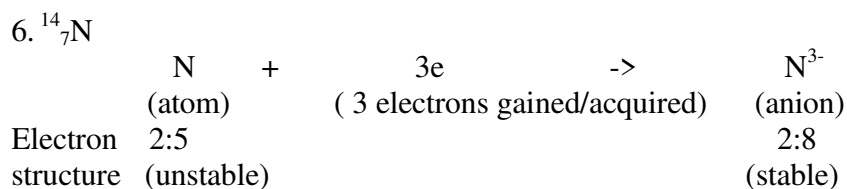
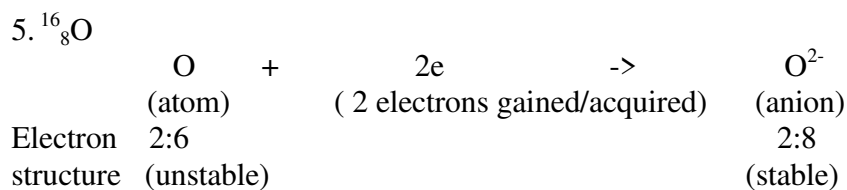
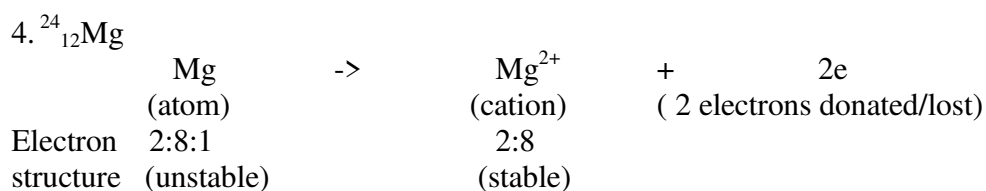
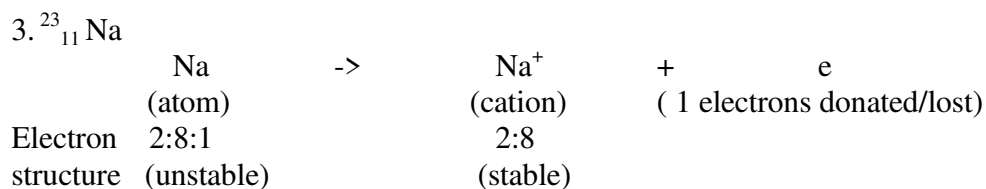
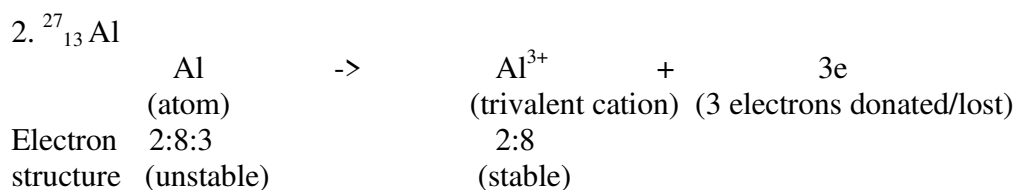

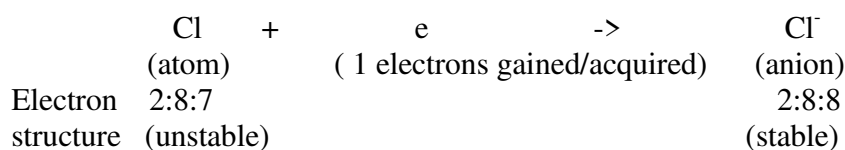
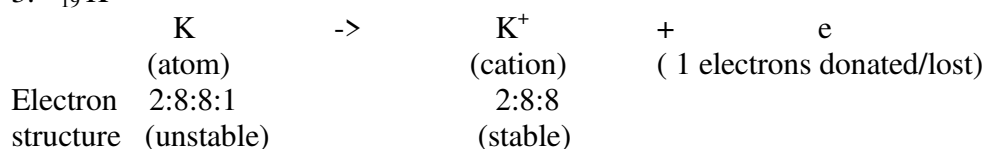
3.  ${}^{39}_{19}\text{K}$ 

When an element donate/loses its outer electrons ,the process is called oxidation. When an element acquires/gains extra electrons in its outer energy level,the process is called reduction.The charge carried by an atom, cation or anion is its oxidation state.

Table showing the oxidation states of some isotopes

Element	Symbol of element / isotopes	Charge of ion	Oxidation state
Hydrogen	${}^1_1\text{H}$	$\text{H}^+$	+1
	${}^2_1\text{H}$ (deuterium)	$\text{H}^+$	+1
	${}^3_1\text{H}$ (Tritium)	$\text{H}^+$	+1
Chlorine	${}^{35}_{17}\text{Cl}$	$\text{Cl}^-$	-1
	${}^{37}_{17}\text{Cl}$	$\text{Cl}^-$	-1
Potassium	${}^{39}_{19}\text{K}$	$\text{K}^+$	+1
	${}^{40}_{19}\text{K}$	$\text{K}^+$	+1
	${}^{41}_{19}\text{K}$	$\text{K}^+$	+1
Oxygen	${}^{16}_8\text{O}$	$\text{O}^{2-}$	-2
	${}^{18}_8\text{O}$	$\text{O}^{2-}$	-2
Magnesium	${}^{24}_{12}\text{Mg}$	$\text{Mg}^{2+}$	+2
sodium	${}^{23}_{11}\text{Na}$	$\text{Na}^+$	+1
Copper	Cu	$\text{Cu}^+$	+1
		$\text{Cu}^{2+}$	+2
Iron		$\text{Fe}^{2+}$	+2
		$\text{Fe}^{3+}$	+3
Lead		$\text{Pb}^{2+}$	+2
		$\text{Pb}^{4+}$	+4



Manganese	$\text{Mn}^{2+}$	+2
	$\text{Mn}^{7+}$	+7
Chromium	$\text{Cr}^{3+}$	+3
	$\text{Cr}^{6+}$	+6
Sulphur	$\text{S}^{4+}$	+4
	$\text{S}^{6+}$	+6
Carbon	$\text{C}^{2+}$	+2
	$\text{C}^{4+}$	+4

Note :

Some elements can exist in **more** than one oxidation state. They are said to have variable oxidation state.

Roman capital numeral is used to indicate the oxidation state of an element with a variable oxidation state in a compound.

Examples:

- (i) Copper (I) means  $\text{Cu}^+$  as in Copper(I)oxide
- (ii) Copper (II) means  $\text{Cu}^{2+}$  as in Copper(II)oxide
- (iii) Iron (II) means  $\text{Fe}^{2+}$  as in Iron(II)sulphide
- (iv) Iron (III) means  $\text{Fe}^{3+}$  as in Iron(III)chloride
- (iv) Sulphur(VI)mean  $\text{S}^{6+}$  as in Iron(III)sulphate(VI)
- (v) Sulphur(VI)mean  $\text{S}^{6+}$  as in sulphur(VI)oxide
- (vi) Sulphur(IV)mean  $\text{S}^{4+}$  as in sulphur(IV)oxide
- (vii) Sulphur(IV)mean  $\text{S}^{4+}$  as in sodium sulphate(IV)
- (ix) Carbon(IV)mean  $\text{C}^{4+}$  as in carbon(IV)oxide
- (x) Carbon(IV)mean  $\text{C}^{4+}$  as in Lead(II)carbonate(IV)
- (xi) Carbon(II)mean  $\text{C}^{2+}$  as in carbon(II)oxide
- (xii) Manganese(IV)mean  $\text{Mn}^{4+}$  as in Manganese(IV)oxide

A compound is a combination of two or more elements in fixed proportions.

The ratio of the atoms making a compound is called the chemical formulae.

Elements combine together to form a compound depending on their combining power.

The combining power of atoms in an element is called Valency. Valency of an element is equal to the **number** of:

- (i) hydrogen atoms that an atom of element can combine with or displace.
- (ii) electrons gained /acquired in outer energy level by non metals to be stable/attain duplet/octet.
- (iii) electrons donated/lost by outer energy level of metals to be stable/attain octet/duplet.
- (iv) charges carried by ions/cations/ions

Group of atoms that react as a unit during chemical reactions are called **radicals**. Elements with variable oxidation state also have more than one valency.

**Table showing the valency of common radicals.**

Radical name	Chemical formulae	Combining power / Valency
Ammonium	$\text{NH}_4^+$	1
Hydroxide	$\text{OH}^-$	1
Nitrate(V)	$\text{NO}_3^-$	1
Hydrogen carbonate	$\text{HCO}_3^-$	1
Hydrogen sulphate(VI)	$\text{HSO}_4^-$	1
Hydrogen sulphate(IV)	$\text{HSO}_3^-$	1
Manganate(VII)	$\text{MnO}_4^-$	1
Chromate(VI)	$\text{CrO}_4^{2-}$	2
Dichromate(VI)	$\text{Cr}_2\text{O}_7^{2-}$	2
Sulphate(VI)	$\text{SO}_4^{2-}$	2
Sulphate(IV)	$\text{SO}_3^{2-}$	2
Carbonate(IV)	$\text{CO}_3^{2-}$	2
Phosphate(V)	$\text{PO}_4^{2-}$	3

**Table showing the valency of some common metal and non metals**

Element/metal	Valency	Element/non metal	Valency
Hydrogen	1	<b>Fluorine</b>	<b>1</b>
Lithium	1	<b>Chlorine</b>	<b>1</b>
Beryllium	2	<b>Bromine</b>	<b>1</b>
Boron	3	<b>Iodine</b>	<b>1</b>
Sodium	1	<b>Carbon</b>	<b>4</b>
Magnesium	2	<b>Nitrogen</b>	<b>3</b>
Aluminium	3	<b>Oxygen</b>	<b>2</b>
Potassium	1	<b>Phosphorus</b>	<b>3</b>
Calcium	2		
Zinc	2		
Barium	2		
Mercury	2		
Iron	2 and 3		
Copper	1 and 2		
Manganese	2 and 4		
Lead	2 and 4		

From the valency of elements, the chemical formula of a compound can be derived using the following procedure:

- (i) Identify the elements and radicals making the compound
  - (ii) Write the symbol/formula of the elements making the compound starting with the metallic element
  - (iii) Assign the valency of each element /radical as superscript.
  - (iv) Interchange/exchange the valencies of each element as subscript.
  - (v) Divide by the smallest/lowest valency to derive the smallest whole number ratios
- Ignore a valency of 1.  
This is the chemical formula.

### Practice examples

Write the chemical formula of

#### (a) Aluminium oxide

Elements making compound	Aluminium	Oxygen
Symbol of elements/radicals in compound	Al	O
Assign valencies as superscript	Al <sup>3</sup>	O <sup>2</sup>
Exchange/Interchange the valencies as subscript	Al <sub>2</sub>	O <sub>3</sub>
Divide by smallest valency to get whole number	-	-

Chemical formula of Aluminium oxide is thus: Al<sub>2</sub>O<sub>3</sub>

**This means: 2 atoms of Aluminium combine with 3 atoms of Oxygen**

#### (b) Sodium oxide

Elements making compound	Sodium	Oxygen
Symbol of elements/radicals in compound	Na	O
Assign valencies as superscript	Na <sup>1</sup>	O <sup>2</sup>
Exchange/Interchange the valencies as subscript	Na <sub>2</sub>	O <sub>1</sub>
Divide by smallest valency to get whole number	-	-

Chemical formula of Sodium oxide is thus: Na<sub>2</sub>O

**This means: 2 atoms of Sodium combine with 1 atom of Oxygen**

#### (c) Calcium oxide

Elements making compound	Calcium	Oxygen
Symbol of elements/radicals in compound	Ca	O
Assign valencies as superscript	Ca <sup>2</sup>	O <sup>2</sup>
Exchange/Interchange the valencies as subscript	Ca <sub>2</sub>	O <sub>2</sub>
Divide by two to get smallest whole number ratio	Ca <sub>1</sub>	O <sub>1</sub>

Chemical formula of Calcium oxide is thus: **CaO**

**This means: 1 atom of calcium combine with 1 atom of Oxygen.**

**(d)Lead(IV)oxide**

Elements making compound	Lead	Oxygen
Symbol of elements/radicals in compound	Pb	O
Assign valencies as superscript	Pb <sup>4</sup>	O <sup>2</sup>
Exchange/Interchange the valencies as subscript	Pb <sub>2</sub>	O <sub>4</sub>
Divide by two to get smallest whole number ratio	Pb <sub>1</sub>	O <sub>2</sub>

Chemical formula of Lead(IV) oxide is thus: **PbO<sub>2</sub>**

**This means: 1 atom of lead combine with 2 atoms of Oxygen.**

**(e)Lead(II)oxide**

Elements making compound	Lead	Oxygen
Symbol of elements/radicals in compound	Pb	O
Assign valencies as superscript	Pb <sup>2</sup>	O <sup>2</sup>
Exchange/Interchange the valencies as subscript	Pb <sub>2</sub>	O <sub>2</sub>
Divide by two to get smallest whole number ratio	Pb <sub>1</sub>	O <sub>1</sub>

Chemical formula of Lead(II) oxide is thus: **PbO**

**This means: 1 atom of lead combine with 1 atom of Oxygen.**

**(e)Iron(III)oxide**

Elements making compound	Iron	Oxygen
Symbol of elements/radicals in compound	Fe	O
Assign valencies as superscript	Fe <sup>3</sup>	O <sup>2</sup>
Exchange/Interchange the valencies as subscript	Fe <sub>2</sub>	O <sub>3</sub>
Divide by two to get smallest whole number ratio	-	-

Chemical formula of Iron(III) oxide is thus: **Fe<sub>2</sub>O<sub>3</sub>**

**This means: 2 atom of lead combine with 3 atom of Oxygen.**

**(f)Iron(II)sulphate(VI)**

Elements making compound	Iron	sulphate(VI)
Symbol of elements/radicals in compound	Fe	SO <sub>4</sub>
Assign valencies as superscript	Fe <sup>2</sup>	SO <sub>4</sub> <sup>2</sup>
Exchange/Interchange the valencies as subscript	Fe <sub>2</sub>	SO <sub>4</sub> <sub>2</sub>
Divide by two to get smallest whole number ratio	Fe <sub>1</sub>	SO <sub>4</sub> <sub>1</sub>

Chemical formula of Iron(II) sulphate(VI) is thus: FeSO<sub>4</sub>

**This means: 1 atom of Iron combine with 1 sulphate(VI) radical.**

**(g) Copper(II) sulphate(VI)**

Elements making compound	Copper	sulphate(VI)
Symbol of elements/radicals in compound	Cu	SO <sub>4</sub>
Assign valencies as superscript	Cu <sup>2</sup>	SO <sub>4</sub> <sup>2</sup>
Exchange/Interchange the valencies as subscript	Cu <sub>2</sub>	SO <sub>4</sub> <sub>2</sub>
Divide by two to get smallest whole number ratio	Cu <sub>1</sub>	SO <sub>4</sub> <sub>1</sub>

Chemical formula of Cu(II) sulphate(VI) is thus: CuSO<sub>4</sub>

**This means: 1 atom of Copper combine with 1 sulphate(VI) radical.**

**(h) Aluminium sulphate(VI)**

Elements making compound	Aluminium	sulphate(VI)
Symbol of elements/radicals in compound	Al	SO <sub>4</sub>
Assign valencies as superscript	Al <sup>3</sup>	SO <sub>4</sub> <sup>2</sup>
Exchange/Interchange the valencies as subscript	Al <sub>2</sub>	SO <sub>4</sub> <sub>3</sub>
Divide by two to get smallest whole number ratio	-	-

Chemical formula of Aluminium sulphate(VI) is thus: Al<sub>2</sub>(SO<sub>4</sub>)<sub>3</sub>

**This means: 2 atom of Aluminium combine with 3 sulphate(VI) radical.**

**(i) Aluminium nitrate(V)**

Elements making compound	Aluminium	nitrate(V)
Symbol of elements/radicals in compound	Al	NO <sub>3</sub>
Assign valencies as superscript	Al <sup>3</sup>	NO <sub>3</sub> <sup>1</sup>
Exchange/Interchange the valencies as subscript	Al <sub>1</sub>	NO <sub>3</sub> <sub>3</sub>
Divide by two to get smallest whole number ratio	-	-

Chemical formula of Aluminium sulphate(VI) is thus: Al(NO<sub>3</sub>)<sub>3</sub>

**This means: 1 atom of Aluminium combine with 3 nitrate(V) radical.**

**(j) Potassium manganate(VII)**

Elements making compound	Potassium	manganate(VII)
Symbol of elements/radicals in compound	K	MnO <sub>4</sub>
Assign valencies as superscript	K <sup>1</sup>	MnO <sub>4</sub> <sup>1</sup>
Exchange/Interchange the valencies as subscript	K <sub>1</sub>	MnO <sub>4</sub> <sub>1</sub>
Divide by two to get smallest whole number ratio	-	-

Chemical formula of Potassium manganate(VII) is thus: **KMnO<sub>4</sub>**

**This means: 1 atom of Potassium combine with 4 manganate(VII) radical.**

**(k) Sodium dichromate(VI)**

Elements making compound	Sodium	dichromate(VI)
Symbol of elements/radicals in compound	Na	Cr <sub>2</sub> O <sub>7</sub>
Assign valencies as superscript	Na <sup>1</sup>	Cr <sub>2</sub> O <sub>7</sub> <sup>2</sup>
Exchange/Interchange the valencies as subscript	Na <sub>2</sub>	Cr <sub>2</sub> O <sub>7</sub> <sub>1</sub>
Divide by two to get smallest whole number ratio	-	-

Chemical formula of Sodium dichromate(VI) is thus: **Na<sub>2</sub>Cr<sub>2</sub>O<sub>7</sub>**

**This means: 2 atom of Sodium combine with 1 dichromate(VI) radical.**

**(l) Calcium hydrogen carbonate**

Elements making compound	Calcium	Hydrogen carbonate
Symbol of elements/radicals in compound	Ca	CO <sub>3</sub>
Assign valencies as superscript	Ca <sup>2</sup>	HCO <sub>3</sub> <sup>1</sup>
Exchange/Interchange the valencies as subscript	Ca <sub>1</sub>	HCO <sub>3</sub> <sub>2</sub>
Divide by two to get smallest whole number ratio	-	-

Chemical formula of Calcium hydrogen carbonate is thus: **Ca(HCO<sub>3</sub>)<sub>2</sub>**

**This means: 1 atom of Calcium combine with 2 hydrogen carbonate radical.**

**(l) Magnesium hydrogen sulphate(VI)**

Elements making compound	Magnesium	Hydrogen sulphate(VI)
Symbol of elements/radicals in compound	Mg	HSO <sub>4</sub>
Assign valencies as superscript	Mg <sup>2</sup>	HSO <sub>4</sub> <sup>1</sup>
Exchange/Interchange the valencies as subscript	Mg <sub>1</sub>	HSO <sub>4</sub> <sub>2</sub>
Divide by two to get smallest whole number ratio	-	-

Chemical formula of Magnesium hydrogen sulphate(VI) is thus: **Mg(HSO<sub>4</sub>)<sub>2</sub>**

**This means: 1 atom of Magnesium combine with 2 hydrogen sulphate(VI) radical.**

Compounds are formed from chemical reactions. A chemical reaction is formed when atoms of the reactants break free to bond again and form products. A chemical reaction is a statement showing the movement of reactants to form products. The following procedure is used in writing a chemical equations:

1. Write the word equation
2. Write the correct chemical formula for each of the reactants and products
3. Check if the number of atoms of **each** element on the reactant side is **equal** to the number of atoms of each element on the product side.
4. Multiply the chemical formula containing the unbalanced atoms with the lowest common multiple if the number of atoms on one side is not equal. This is called **balancing**.

**Do not change the chemical formula of the products/reactants.**

5. Assign in brackets, the physical state/state symbols of the reactants and products after each chemical formula as:

- (i) **(s)** for solids
- (ii) **(l)** for liquids
- (iii) **(g)** for gas
- (iv) **(aq)** for aqueous/dissolved in water to make a solution.

### Practice examples

**Write a balanced chemical equation for the following**

- (a) Hydrogen gas is prepared from reacting Zinc granules with dilute hydrochloric acid.

Procedure

1. Write the word equation

**Zinc + Hydrochloric acid -> Zinc chloride + hydrogen gas**

2. Write the correct chemical formula for each of the reactants and products



3. Check if the number of atoms of **each** element on the reactant side is **equal** to the number of atoms of each element on the product side.

**Number of atoms of Zn on the reactant side is equal to product side**

**One atom of H in HCl on the reactant side is not equal to two atoms in H<sub>2</sub> on product side.**

**One atom of Cl in HCl on the reactant side is not equal to two atoms in ZnCl<sub>2</sub> on product side.**

4. Multiply the chemical formula containing the **unbalanced** atoms with the lowest common multiple if the number of atoms on one side is not equal.

**Multiply HCl by “2” to get “2” Hydrogen and “2” Chlorine on product and reactant side.**



5. Assign in brackets, the physical state/state symbols .



(b) Oxygen gas is prepared from decomposition of Hydrogen peroxide solution to water

Procedure

1. Write the word equation

**Hydrogen peroxide -> Water + oxygen gas**

2. Write the correct chemical formula for each of the reactants and products



3. Check if the number of atoms of **each** element on the reactant side is **equal** to the number of atoms of each element on the product side.

**Number of atoms of H on the reactant side is equal to product side**

**Two atom of O in H<sub>2</sub>O<sub>2</sub> on the reactant side is not equal to three atoms (one in H<sub>2</sub>O and two in O<sub>2</sub>) on product side.**

4. Multiply the chemical formula containing the **unbalanced** atoms with the lowest common multiple if the number of atoms on one side is not equal.

**Multiply H<sub>2</sub>O<sub>2</sub> by "2" to get "4" Hydrogen and "4" Oxygen on reactants**

**Multiply H<sub>2</sub>O by "2" to get "4" Hydrogen and "2" Oxygen on product side**

**When the "2" Oxygen in O<sub>2</sub> and the "2" in H<sub>2</sub>O are added on product side they are equal to the "4" Oxygen on reactants side.**

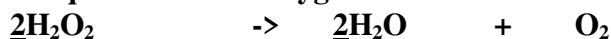

5. Assign in brackets, the physical state/state symbols .

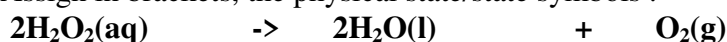

(c) Chlorine gas is prepared from Potassium manganate(VII) reacting with hydrochloric acid to form potassium chloride solution, manganese(II) chloride solution, water and chlorine gas.

Procedure

1. Write the word equation

**Potassium manganate(VII) + Hydrochloric acid ->**

**potassium chloride + manganese(II) chloride + chlorine + water**

2. Write the correct chemical formula for each of the reactants and products



3. Check if the number of atoms of **each** element on the reactant side is **equal** to the number of atoms of each element on the product side.



Number of atoms of K and Mn on the reactant side is equal to product side

Two atom of H in H<sub>2</sub>O on the product side is not equal to one atom on reactant side.

Four atom of O in KMnO<sub>4</sub> is not equal to one in H<sub>2</sub>O

One atom of Cl in HCl on reactant side is not equal to three (one in H<sub>2</sub>O and two in Cl<sub>2</sub>)

4. Multiply the chemical formula containing the **unbalanced** atoms with the lowest common multiple if the number of atoms on one side is not equal.

**Multiply HCl by “16” to get “16” Hydrogen and “16” Chlorine on reactants**

**Multiply KMnO<sub>4</sub> by “2” to get “2” Potassium and “2” manganese, “2 x 4 =8” Oxygen on reactant side.**

**Balance the product side to get:**

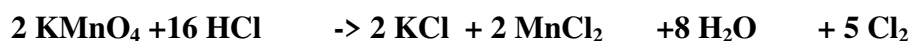

5. Assign in brackets, the physical state/state symbols .

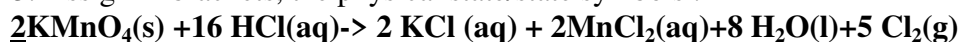

(d) Carbon(IV)oxide gas is prepared from Calcium carbonate reacting with hydrochloric acid to form calcium chloride solution, water and carbon(IV)oxide gas.

Procedure

1. Write the word equation

**Calcium carbonate + Hydrochloric acid ->  
calcium chloride solution+ water +carbon(IV)oxide**

2. Write the correct chemical formula for each of the reactants and products



3. Check if the number of atoms of **each** element on the reactant side is **equal** to the number of atoms of each element on the product side.

4. Multiply the chemical formula containing the **unbalanced** atoms with the lowest common multiple if the number of atoms on one side is not equal.

5. Assign in brackets, the physical state/state symbols .



(d) Sodium hydroxide solution neutralizes hydrochloric acid to form salt and water.

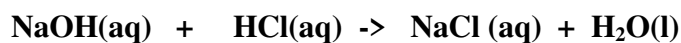

(e) Sodium reacts with water to form sodium hydroxide and hydrogen gas.



(f) Calcium reacts with water to form calcium hydroxide and hydrogen gas

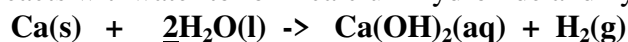

(g) Copper(II) Oxide solid reacts with dilute hydrochloric acid to form copper(II) chloride and water.

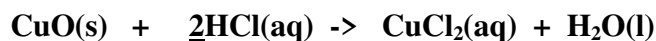

(h) Hydrogen sulphide reacts with Oxygen to form sulphur(IV) Oxide and water.

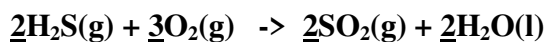

(i) Magnesium reacts with steam to form Magnesium Oxide and Hydrogen gas.

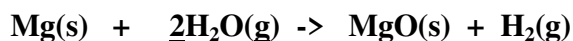

(j) Ethane(C<sub>2</sub>H<sub>6</sub>) gas burns in air to form Carbon(IV) Oxide and water.

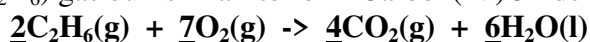

(k) Ethene(C<sub>2</sub>H<sub>4</sub>) gas burns in air to form Carbon(IV) Oxide and water.

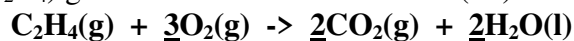

(l) Ethyne(C<sub>2</sub>H<sub>2</sub>) gas burns in air to form Carbon(IV) Oxide and water.



## C.PERIODICITY OF CHEMICAL FAMILIES/DOWN THE GROUP.

The number of valence electrons and the number of occupied energy levels in an atom of an element determine the position of an element in the periodic table.i.e

The number of occupied energy levels determine the Period and the valence electrons determine the Group.

Elements in the same group have similar physical and chemical properties. The trends in physical and chemical properties of elements in the same group vary down the group. Elements in the same group thus constitute a chemical family.

### (a)Group I elements: Alkali metals

Group I elements are called **Alkali metals** except Hydrogen which is a non metal. The alkali metals include:

Element	Symbol	Atomic number	Electron structure	Oxidation state	Valency
Lithium	Li	3	2:1	Li <sup>+</sup>	1
Sodium	Na	11	2:8:1	Na <sup>+</sup>	1
Potassium	K	19	2:8:8:1	K <sup>+</sup>	1
Rubidium	Rb	37	2:8:18:8:1	Rb <sup>+</sup>	1
Caesium	Cs	55	2:8:18:18:8:1	Cs <sup>+</sup>	1
Francium	Fr	87	2:8:18:32:18:8:1	Fr <sup>+</sup>	1

All alkali metals atom has one electron in the outer energy level. They therefore are **monovalent**. They donate /lose the outer electron to have oxidation state M<sup>+</sup> The number of energy levels increases down the group from Lithium to Francium. The more the number of energy levels the bigger/larger the atomic size. e.g.

The atomic size of Potassium is bigger/larger than that of sodium because Potassium has more/4 energy levels than sodium (3 energy levels).

### Atomic and ionic radius

The distance between the centre of the nucleus of an **atom** and the outermost energy level occupied by electron/s is called **atomic radius**. Atomic radius is measured in **nanometers(n)**.The higher /bigger the atomic radius the bigger /larger the atomic size.

The distance between the centre of the nucleus of an **ion** and the outermost energy level occupied by electron/s is called **ionic radius**. Ionic radius is also

measured in **nanometers**(n).The higher /bigger the ionic radius the bigger /larger the size of the ion.

Atomic radius and ionic radius depend on the number of energy levels occupied by electrons. The more the number of energy levels the bigger/larger the atomic /ionic radius. e.g.

The atomic radius of Francium is bigger/larger than that of sodium because Francium has more/7 energy levels than sodium (3 energy levels).

Atomic radius and ionic radius of alkali metals increase down the group as the number of energy levels increases.

The atomic radius of alkali metals is bigger than the ionic radius. This is because alkali metals react by losing/donating the outer electron and hence lose the outer energy level.

#### **Table showing the atomic and ionic radius of some alkali metals**

Element	Symbol	Atomic number	Atomic radius(nM)	Ionic radius(nM)
Lithium	Li	3	0.133	0.060
Sodium	Na	11	0.157	0.095
Potassium	K	19	0.203	0.133

The atomic radius of sodium is 0.157nM .The ionic radius of  $\text{Na}^+$  is 0.095nM. This is because sodium reacts by donating/losing the outer electrons and hence the outer energy level. The remaining electrons/energy levels experience more effective / greater nuclear attraction/pull towards the nucleus reducing the atomic radius.

#### **Electropositivity**

The ease of donating/losing electrons is called electropositivity. All alkali metals are electropositive. Electropositivity increase as atomic radius increase. This is because the effective nuclear attraction on outer electrons decreases with increase in atomic radius. The outer electrons experience less nuclear attraction and can be lost/ donated easily/with ease. Francium is the most electropositive element in the periodic table because it has the highest/biggest atomic radius.

#### **Ionization energy**

The minimum amount of energy required to remove an electron from an atom of element in its gaseous state is called **1<sup>st</sup> ionization energy**. The SI unit of ionization energy is **kilojoules per mole/kJmole<sup>-1</sup>** .Ionization energy depend on atomic radius. The higher the atomic radius, the less effective the nuclear attraction on outer electrons/energy level and thus the lower the ionization energy. For alkali metals the 1<sup>st</sup> ionization energy decrease down the group as

the atomic radius increase and the effective nuclear attraction on outer energy level electrons decrease.

e.g. The 1<sup>st</sup> ionization energy of sodium is 496 kJmole<sup>-1</sup> while that of potassium is 419 kJmole<sup>-1</sup>. This is because atomic radius increase and thus effective nuclear attraction on outer energy level electrons decrease down the group from sodium to Potassium. It requires therefore less energy to donate/lose outer electrons in Potassium than in sodium.

### Physical properties

**Soft/Easy to cut:** Alkali metals are soft and easy to cut with a knife. The softness and ease of cutting increase down the group from Lithium to Francium. This is because an increase in atomic radius, decreases the strength of metallic bond and the packing of the metallic structure

**Appearance:** Alkali metals have a shiny grey metallic luster when freshly cut. The surface rapidly/quickly tarnishes on exposure to air. This is because the metal surface rapidly/quickly reacts with elements of air/oxygen.

**Melting and boiling points:** Alkali metals have a relatively low melting/boiling point than common metals like Iron. This is because alkali metals use only one delocalized electron to form a weak metallic bond/structure.

**Electrical/thermal conductivity:** Alkali metals are good thermal and electrical conductors. Metals conduct using the outer mobile delocalized electrons. The delocalized electrons move randomly within the metallic structure.

### Summary of some physical properties of the 1<sup>st</sup> three alkali metals

Alkali metal	Appearance	Ease of cutting	Melting point (°C)	Boiling point (°C)	Conductivity	1 <sup>st</sup> ionization energy
Lithium	Silvery white	Not easy	180	1330	Good	520
Sodium	Shiny grey	Easy	98	890	Good	496
Potassium	Shiny grey	Very easy	64	774	Good	419

### Chemical properties

#### **(i)Reaction with air/oxygen**

On exposure to air, alkali metals reacts with the elements in the air.

Example

On exposure to air, Sodium first reacts with Oxygen to form sodium oxide.

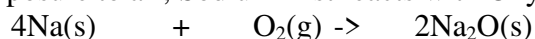

The sodium oxide formed further reacts with water/moisture in the air to form sodium hydroxide solution.

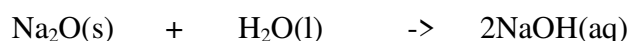

Sodium hydroxide solution reacts with carbon(IV)oxide in the air to form sodium carbonate.



### (ii) Burning in air/oxygen

Lithium burns in air with a **crimson**/deep red flame to form Lithium oxide

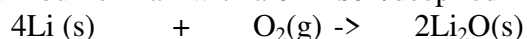

Sodium burns in air with a **yellow** flame to form sodium oxide

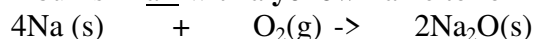

Sodium burns in oxygen with a **yellow** flame to form sodium peroxide

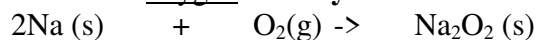

Potassium burns in air with a **lilac/purple** flame to form potassium oxide

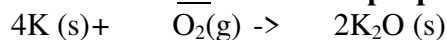

### (iii) Reaction with water:

#### Experiment

Measure 500 cm<sup>3</sup> of water into a beaker.

Put three drops of phenolphthalein indicator.

Put about 0.5g of Lithium metal into the beaker.

Determine the pH of final product

Repeat the experiment using about 0.1 g of Sodium and Potassium.

**Caution:** Keep a distance

#### Observations

Alkali metal	Observations	Comparative speed/rate of the reaction
Lithium	-Metal floats in water -rapid effervescence/fizzing/bubbling -colourless gas produced (that extinguishes burning splint with explosion /“pop” sound) -resulting solution turn phenolphthalein indicator pink -pH of solution = 12/13/14	Moderately vigorous
Sodium	-Metal floats in water -very rapid effervescence /fizzing /bubbling -colourless gas produced (that extinguishes burning splint with explosion /“pop” sound) -resulting solution turn	Very vigorous

	phenolphthalein indicator pink -pH of solution = 12/13/14	
Potassium	-Metal floats in water -explosive effervescence /fizzing /bubbling -colourless gas produced (that extinguishes burning splint with explosion /“pop” sound) -resulting solution turn phenolphthalein indicator pink -pH of solution = 12/13/14	Explosive/burst into flames

### Explanation

Alkali metals are less dense than water. They therefore float in water. They react with water to form a strongly alkaline solution of their hydroxides and producing hydrogen gas. The rate of this reaction increase down the group. i.e. Potassium is more reactive than sodium. Sodium is more reactive than Lithium. The reactivity increases as electropositivity increases of the alkali increases. This is because as the atomic radius increases, the ease of donating/losing outer electron increase during chemical reactions.

### Chemical equations

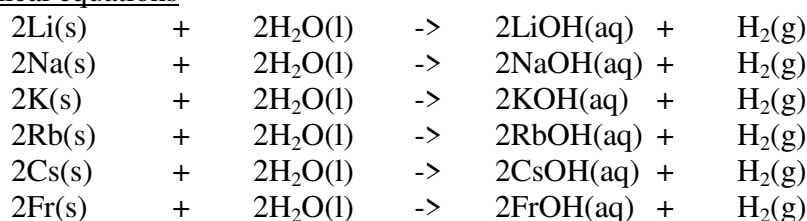

↓  
Reactivity increase down the group

### **(iv) Reaction with chlorine:**

#### Experiment

Cut about 0.5g of sodium into a deflagrating spoon with a lid cover. Introduce it on a Bunsen flame until it catches fire. Quickly and carefully lower it into a gas jar containing dry chlorine to cover the gas jar.

Repeat with about 0.5g of Lithium.

**Caution:** This experiment should be done in fume chamber because chlorine is poisonous /toxic.

#### Observation

Sodium metal continues to burn with a yellow flame forming white solid/fumes.

Lithium metal continues to burn with a crimson flame forming white solid / fumes.

Alkali metal react with chlorine gas to form the corresponding metal chlorides. The reactivity increase as electropositivity increase down the group from Lithium to Francium. The ease of donating/losing the outer electrons increase as the atomic radius increase and the outer electron is less attracted to the nucleus.

#### Chemical equations

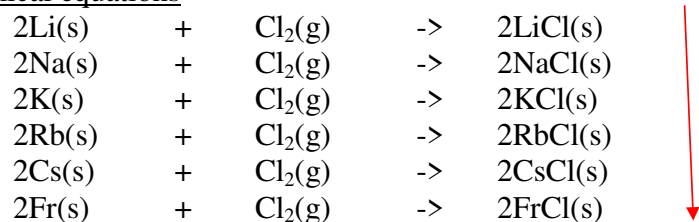

Reactivity increase down the group

The table below shows some compounds of the 1<sup>st</sup> three alkali metals

	Lithium	sodium	Potassium
Hydroxide	LiOH	NaOH	KOH
Oxide	Li <sub>2</sub> O	Na <sub>2</sub> O	K <sub>2</sub> O
Sulphide	Li <sub>2</sub> S	Na <sub>2</sub> S	K <sub>2</sub> S
Chloride	LiCl	NaCl	KCl
Carbonate	Li <sub>2</sub> CO <sub>3</sub>	Na <sub>2</sub> CO <sub>3</sub>	K <sub>2</sub> CO <sub>3</sub>
Nitrate(V)	LiNO <sub>3</sub>	NaNO <sub>3</sub>	KNO <sub>3</sub>
Nitrate(III)	-	NaNO <sub>2</sub>	KNO <sub>2</sub>
Sulphate(VI)	Li <sub>2</sub> SO <sub>4</sub>	Na <sub>2</sub> SO <sub>4</sub>	K <sub>2</sub> SO <sub>4</sub>
Sulphate(IV)	-	Na <sub>2</sub> SO <sub>3</sub>	K <sub>2</sub> SO <sub>3</sub>
Hydrogen carbonate	-	NaHCO <sub>3</sub>	KHCO <sub>3</sub>
Hydrogen sulphate(VI)	-	NaHSO <sub>4</sub>	KHSO <sub>4</sub>
Hydrogen sulphate(IV)	-	NaHSO <sub>3</sub>	KHSO <sub>3</sub>
Phosphate	-	Na <sub>3</sub> PO <sub>4</sub>	K <sub>3</sub> PO <sub>4</sub>
Manganate(VI)	-	NaMnO <sub>4</sub>	KMnO <sub>4</sub>
Dichromate(VI)	-	Na <sub>2</sub> Cr <sub>2</sub> O <sub>7</sub>	K <sub>2</sub> Cr <sub>2</sub> O <sub>7</sub>
Chromate(VI)	-	Na <sub>2</sub> CrO <sub>4</sub>	K <sub>2</sub> CrO <sub>4</sub>

Some **uses** of alkali metals include:

- (i) Sodium is used in making sodium cyanide for extracting gold from gold ore.
- (ii) Sodium chloride is used in seasoning food.
- (iii) Molten mixture of sodium and potassium is used as coolant in nuclear reactors.
- (iv) Sodium is used in making sodium hydroxide used in making soapy and soapless detergents.



(v) Sodium is used as a reducing agent for the extraction of titanium from Titanium(IV)chloride.

(vi) Lithium is used in making special high strength glasses

(vii) Lithium compounds are used to make dry cells in mobile phones and computer laptops.

## Group II elements: Alkaline earth metals

Group II elements are called **Alkaline earth metals** . The alkaline earth metals include:

Element	Symbol	Atomic number	Electron structure	Oxidation state	Valency
Beryllium	Be	4	2:2	Be <sup>2+</sup>	2
Magnesium	Mg	12	2:8:2	Mg <sup>2+</sup>	2
Calcium	Ca	20	2:8:8:2	Ca <sup>2+</sup>	2
Strontium	Sr	38	2:8:18:8:2	Sr <sup>2+</sup>	2
Barium	Ba	56	2:8:18:18:8:2	Ba <sup>2+</sup>	2
Radium	Ra	88	2:8:18:32:18:8:2	Ra <sup>2+</sup>	2

All alkaline earth metal atoms have two electrons in the outer energy level.

They therefore are **divalent**. They donate /lose the two outer electrons to have oxidation state M<sup>2+</sup>

The number of energy levels increases down the group from Beryllium to Radium. The more the number of energy levels the bigger/larger the atomic size. e.g.

The atomic size/radius of Calcium is bigger/larger than that of Magnesium because Calcium has more/4 energy levels than Magnesium (3 energy levels).

Atomic radius and ionic radius of alkaline earth metals increase down the group as the number of energy levels increases.

The atomic radius of alkaline earth metals is bigger than the ionic radius. This is because they react by losing/donating the two outer electrons and hence lose the outer energy level.

### **Table showing the atomic and ionic radius of the 1<sup>st</sup> three alkaline earth metals**

Element	Symbol	Atomic number	Atomic radius(nM)	Ionic radius(nM)
Beryllium	Be	4	0.089	0.031
Magnesium	Mg	12	0.136	0.065

Calcium	Ca	20	0.174	0.099
---------	----	----	-------	-------

The atomic radius of Magnesium is 0.136nM. The ionic radius of  $Mg^{2+}$  is 0.065nM. This is because Magnesium reacts by donating/losing the two outer electrons and hence the outer energy level. The remaining electrons/energy levels experience more effective / greater nuclear attraction/pull towards the nucleus reducing the atomic radius.

### Electropositivity

All alkaline earth metals are also electropositive like alkali metals. The electropositivity increase with increase in atomic radius/size. Calcium is more electropositive than Magnesium. This is because the effective nuclear attraction on outer electrons decreases with increase in atomic radius. The two outer electrons in calcium experience less nuclear attraction and can be lost/ donated easily/with ease because of the higher/bigger atomic radius.

### Ionization energy

For alkaline earth metals the 1<sup>st</sup> ionization energy decrease down the group as the atomic radius increase and the effective nuclear attraction on outer energy level electrons decrease.

e.g. The 1<sup>st</sup> ionization energy of Magnesium is  $900 \text{ kJmole}^{-1}$  while that of Calcium is  $590 \text{ kJmole}^{-1}$ . This is because atomic radius increase and thus effective nuclear attraction on outer energy level electrons decrease down the group from magnesium to calcium.

It requires therefore less energy to donate/lose outer electron in calcium than in magnesium.

The minimum amount of energy required to remove a second electron from an ion of an element in its gaseous state is called the **2<sup>nd</sup> ionization energy**.

The 2<sup>nd</sup> ionization energy is always higher /bigger than the 1<sup>st</sup> ionization energy.

This because once an electron is donated /lost form an atom, the overall effective nuclear attraction on the remaining electrons/energy level increase.

Removing a second electron from the ion require therefore more energy than the first electron.

The atomic radius of alkali metals is higher/bigger than that of alkaline earth metals. This is because across/along the period from left to right there is an increase in nuclear charge from additional number of protons and still additional number of electrons entering the same energy level. Increase in nuclear charge increases the effective nuclear attraction on the outer energy level which pulls it closer to the nucleus. e.g.

Atomic radius of Sodium (0.157nM) is higher than that of Magnesium (0.137nM). This is because Magnesium has more effective nuclear attraction on

the outer energy level than Sodium hence pulls outer energy level more nearer to its nucleus.

---

### Physical properties

**Soft/Easy to cut:** Alkaline earth metals are **not** soft and easy to cut with a knife like alkali metals. This is because of the decrease in atomic radius of corresponding alkaline earth metal, increases the strength of metallic bond and the packing of the metallic structure. Alkaline earth metals are

- (i) ductile (able to form wire/thin long rods)
- (ii) malleable (able to be hammered into sheet/long thin plates)
- (iii) have high tensile strength (able to be coiled without breaking/ not brittle/withstand stress)

**Appearance:** Alkali earth metals have a shiny grey metallic luster when their surface is freshly polished /scrubbed. The surface slowly tarnishes on exposure to air. This is because the metal surface slowly undergoes oxidation to form an oxide. This oxide layer should be removed before using the alkaline earth metals.

**Melting and boiling points:** Alkaline earth metals have a relatively high melting/ boiling point than alkali metals. This is because alkali metals use only one delocalized electron to form a weaker metallic bond/structure. Alkaline earth metals use two delocalized electrons to form a stronger metallic bond /structure.

The melting and boiling points decrease down the group as the atomic radius/size increase reducing the strength of metallic bond and packing of the metallic structure. e.g.

Beryllium has a melting point of 1280°C. Magnesium has a melting point of 650°C. Beryllium has a smaller atomic radius/size than magnesium. The strength of metallic bond and packing of the metallic structure is thus stronger in beryllium.

**Electrical/thermal conductivity:** Alkaline earth metals are good thermal and electrical conductors. The two delocalized valence electrons move randomly within the metallic structure.

Electrical conductivity increase down the group as the atomic radius/size increase making the delocalized outer electrons less attracted to nucleus.

Alkaline earth metals are better thermal and electrical conductors than alkali metals because they have more/two outer delocalized electrons.e.g.

---

Magnesium is a better conductor than sodium because it has more/two delocalized electrons than sodium. The more delocalized electrons the better the electrical conductor.

---

Calcium is a better conductor than magnesium.

Calcium has bigger/larger atomic radius than magnesium because the delocalized electrons are less attracted to the nucleus of calcium and thus more free /mobile and thus better the electrical conductor

### Summary of some physical properties of the 1<sup>st</sup> three alkaline earth metals

Alkaline earth metal	Appearance	Ease of cutting	Melting point (°C)	Boiling point (°C)	Conductivity	1 <sup>st</sup> ionization energy	2 <sup>nd</sup> ionization energy
Beryllium	Shiny grey	Not easy	1280	3450	Good	900	1800
Magnesium	Shiny grey	Not Easy	650	1110	Good	736	1450
calcium	Shiny grey	Not easy	850	1140	Good	590	970

### Chemical properties

#### **(i)Reaction with air/oxygen**

On exposure to air, the surface of alkaline earth metals is slowly oxidized to its oxide on prolonged exposure to air.

Example

On exposure to air, the surface of magnesium ribbon is oxidized to form a thin film of Magnesium oxide



#### **(ii)Burning in air/oxygen**

##### Experiment

Hold a about 2cm length of Magnesium ribbon on a Bunsen flame. Stop heating when it catches fire/start burning.

**Caution:** Do not look directly at the flame

Put the products of burning into 100cm<sup>3</sup> beaker. Add about 5cm<sup>3</sup> of distilled water. Swirl. Test the mixture using litmus papers.

Repeat with Calcium

##### Observations

- Magnesium burns with a bright blinding flame
- White solid /ash produced
- Solid dissolves in water to form a colourless solution
- Blue litmus paper remain blue
- Red litmus paper turns blue
- colourless gas with pungent smell of urine

##### Explanation

Magnesium burns in air with a bright blinding flame to form a mixture of Magnesium oxide and Magnesium nitride.

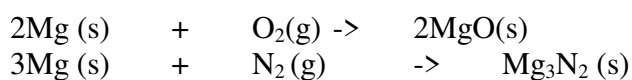

Magnesium oxide dissolves in water to form magnesium hydroxide.

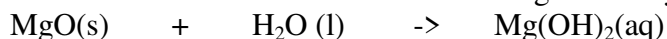

Magnesium nitride dissolves in water to form magnesium hydroxide and produce ammonia gas.

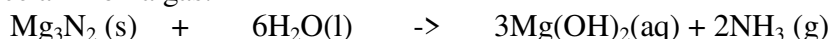

Magnesium hydroxide and ammonia are weakly alkaline with pH 8/9/10/11 and turns red litmus paper blue.

Calcium burns in air with faint orange/red flame to form a mixture of both Calcium oxide and calcium nitride.

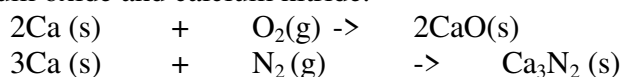

Calcium oxide dissolves in water to form calcium hydroxide.

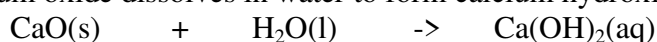

Calcium nitride dissolves in water to form calcium hydroxide and produce ammonia gas.

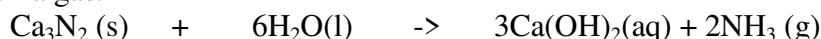

Calcium hydroxide is also weakly alkaline solution with pH 8/9/10/11 and turns red litmus paper blue.

### **(iii)Reaction with water**

#### Experiment

Measure 50 cm<sup>3</sup> of distilled water into a beaker.

Scrub/polish with sand paper 1cm length of Magnesium ribbon

Place it in the water. Test the product-mixture with blue and red litmus papers.

Repeat with Calcium metal.

#### Observations

-Surface of magnesium covered by bubbles of colourless gas.

-Colourless solution formed.

-Effervescence/bubbles/fizzing takes place in Calcium.

-Red litmus paper turns blue.

-Blue litmus paper remains blue.

#### Explanations

Magnesium slowly reacts with cold water to form Magnesium hydroxide and bubbles of Hydrogen gas that stick on the surface of the ribbon.



Calcium moderately reacts with cold water to form Calcium hydroxide and produce a steady stream of Hydrogen gas.

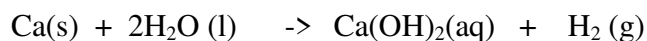

#### (iv) Reaction with water vapour/steam

##### Experiment

Put some cotton wool soaked in water/wet sand in a long boiling tube.

Coil a well polished magnesium ribbon into the boiling tube.

Ensure the coil touches the side of the boiling tube. Heat the cotton wool/sand slightly then strongly heat the Magnesium ribbon .

##### Set up of apparatus

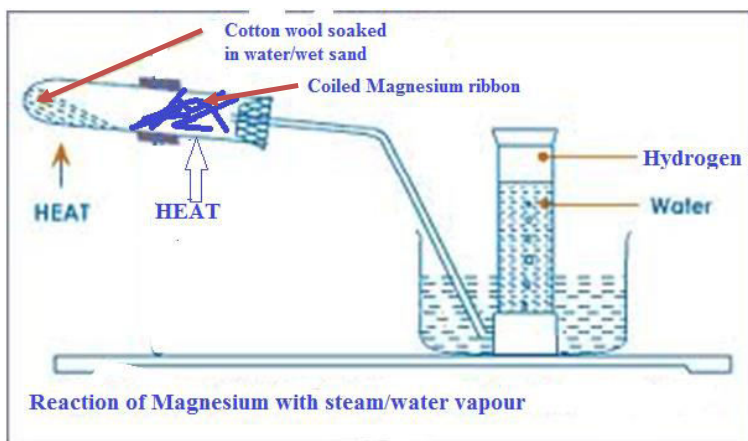

##### Observations

- Magnesium glows red hot then burns with a blinding flame.
- Magnesium continues to glow/burning even without more heating.
- White solid/residue.
- colourless gas collected over water.

##### Explanation

On heating wet sand, steam is generated which drives out the air that would otherwise react with /oxidize the ribbon.

Magnesium burns in steam/water vapour generating enough heat that ensures the reaction goes to completion even without further heating. White Magnesium oxide is formed and hydrogen gas is evolved.

To prevent suck back, the delivery tube should be removed from the water before heating is stopped at the end of the experiment.

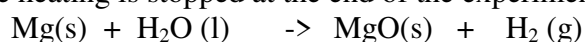

**(v)Reaction with chlorine gas.**Experiment

Lower slowly a burning magnesium ribbon/shavings into a gas jar containing Chlorine gas. Repeat with a hot piece of calcium metal.

Observation

- Magnesium continues to burn in chlorine with a bright blinding flame.
- Calcium continues to burn for a short time.
- White solid formed .
- Pale green colour of chlorine fades.

Explanation

Magnesium continues to burn in chlorine gas forming white magnesium oxide solid.



Calcium burns slightly in chlorine gas to form white calcium oxide solid.

Calcium oxide formed coat unreacted Calcium stopping further reaction

**(v)Reaction with dilute acids.**Experiment

Place about 4.0cm<sup>3</sup> of 0.1M dilute sulphuric(VI)acid into a test tube. Add about 1.0cm length of magnesium ribbon into the test tube. Cover the mouth of the test tube using a thumb. Release the gas and test the gas using a burning splint. Repeat with about 4.0cm<sup>3</sup> of 0.1M dilute hydrochloric/nitric(V) acid. Repeat with 0.1g of Calcium in a beaker with all the above acid

**Caution:** Keep distance when using calcium

Observation

- Effervescence/fizzing/bubbles with dilute sulphuric(VI) and nitric(V) acids
- Little Effervescence/fizzing/bubbles with calcium and dilute sulphuric(VI) acid.
- Colourless gas produced that extinguishes a burning splint with an explosion/“pop” sound.
- No gas is produced with Nitric(V)acid.
- Colourless solution is formed.

Explanation

Dilute acids react with alkaline earth metals to form a salt and produce hydrogen gas.

Nitric(V)acid is a strong oxidizing agent. It quickly oxidizes the hydrogen produced to water.

Calcium is very reactive with dilute acids and thus a very **small** piece of very **dilute** acid should be used.

Chemical equations

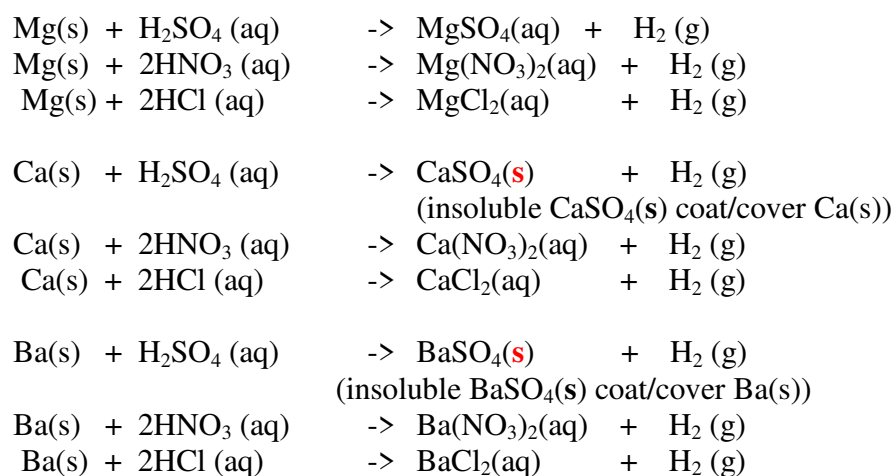

The table below shows some compounds of some alkaline earth metals

	Beryllium	Magnesium	Calcium	Barium
Hydroxide	Be(OH) <sub>2</sub>	Mg(OH) <sub>2</sub>	Ca(OH) <sub>2</sub>	Ba(OH) <sub>2</sub>
Oxide	BeO	MgO	CaO	BaO
Sulphide	-	MgS	CaS	BaS
Chloride	BeCl <sub>2</sub>	MgCl <sub>2</sub>	CaCl <sub>2</sub>	BaCl <sub>2</sub>
Carbonate	BeCO <sub>3</sub>	MgCO <sub>3</sub>	CaCO <sub>3</sub>	BaCO <sub>3</sub>
Nitrate(V)	Be(NO <sub>3</sub> ) <sub>2</sub>	Mg(NO <sub>3</sub> ) <sub>2</sub>	Ca(NO <sub>3</sub> ) <sub>2</sub>	Ba(NO <sub>3</sub> ) <sub>2</sub>
Sulphate(VI)	BeSO <sub>4</sub>	MgSO <sub>4</sub>	CaSO <sub>4</sub>	BaSO <sub>4</sub>
Sulphate(IV)	-	-	CaSO <sub>3</sub>	BaSO <sub>3</sub>
Hydrogen carbonate	-	Mg(HCO <sub>3</sub> ) <sub>2</sub>	Ca(HCO <sub>3</sub> ) <sub>2</sub>	-
Hydrogen sulphate(VI)	-	Mg(HSO <sub>4</sub> ) <sub>2</sub>	Ca(HSO <sub>4</sub> ) <sub>2</sub>	-

Some uses of alkaline earth metals include:

- (i) Magnesium hydroxide is a non-toxic/poisonous mild base used as an anti acid medicine to relieve stomach acidity.
- (ii) Making **duralumin**. Duralumin is an alloy of Magnesium and aluminium used for making aeroplane bodies because it is light.
- (iii) Making plaster of Paris-Calcium sulphate(VI) is used in hospitals to set a fractures bone.
- (iii) Making cement-Calcium carbonate is mixed with clay and sand then heated to form cement for construction/building.
- (iv) Raise soil pH-Quicklime/calcium oxide is added to acidic soils to neutralize and raise the soil pH in agricultural farms.
- (v) As nitrogenous fertilizer-Calcium nitrate(V) is used as an agricultural fertilizer because plants require calcium for proper growth.



(vi) In the blast furnace-Limestone is added to the blast furnace to produce more reducing agent and remove slag in the blast furnace for extraction of Iron.

### (c) Group VII elements: Halogens

Group VII elements are called **Halogens**. They are all non metals. They include:

Element	Symbol	Atomic number	Electronic configuration	Charge of ion	Valency	State at Room Temperature
Fluorine	F	9	2:7	F <sup>-</sup>	1	Pale yellow gas
Chlorine	Cl	17	2:8:7	Cl <sup>-</sup>	1	Pale green gas
Bromine	Br	35	2:8:18:7	Br <sup>-</sup>	1	Red liquid
Iodine	I	53	2:8:18:18:7	I <sup>-</sup>	1	Grey Solid
Astatine	At	85	2:8:18:32:18:7	At <sup>-</sup>	1	Radioactive

All halogen atoms have seven electrons in the outer energy level. They **acquire/gain one** electron in the outer energy level to be stable. They therefore are therefore **monovalent**. They exist in oxidation state X<sup>-</sup>

The number of energy levels increases down the group from Fluorine to Astatine. The more the number of energy levels the bigger/larger the atomic size. e.g.

The atomic size/radius of Chlorine is bigger/larger than that of Fluorine because Chlorine has more/3 energy levels than Fluorine (2 energy levels).

Atomic radius and ionic radius of Halogens increase down the group as the number of energy levels increases.

The atomic radius of Halogens is smaller than the ionic radius. This is because they react by gaining/acquiring extra one electron in the outer energy level. The effective nuclear attraction on the more/extra electrons decreases. The incoming extra electron is also repelled causing the outer energy level to expand to reduce the repulsion and accommodate more electrons.

#### Table showing the atomic and ionic radius of four Halogens

Element	Symbol	Atomic number	Atomic radius(nM)	Ionic radius(nM)
Fluorine	F	9	0.064	0.136
Chlorine	Cl	17	0.099	0.181
Bromine	Br	35	0.114	0.195
Iodine	I	53	0.133	0.216

The atomic radius of Chlorine is 0.099nM .The ionic radius of Cl<sup>-</sup> is 0.181nM. This is because Chlorine atom/molecule reacts by gaining/acquiring extra one electrons. The more/extra electrons/energy level experience less effective nuclear attraction /pull towards the nucleus .The outer enegy level expand/increase to reduce the repulsion of the existing and incoming gained /acquired electrons.

#### Electronegativity

The ease of gaining/acquiring extra electrons is called electronegativity. All halogens are electronegative. Electronegativity decreases as atomic radius increase. This is because the effective nuclear attraction on outer electrons decreases with increase in atomic radius.

The outer electrons experience less nuclear attraction and thus ease of gaining/acquiring extra electrons decrease.

It is measured using Pauling's scale.

Where Fluorine with Pauling scale 4.0 is the most electronegative element and thus the highest tendency to acquire/gain extra electron.

Table showing the electronegativity of the halogens.

Halogen	F	Cl	Br	I	At
Electronegativity (Pauling scale)	4.0	3.0	2.8	2.5	2.2

The electronegativity of the halogens decrease down the group from fluorine to Astatine. This is because atomic radius increases down the group and thus decrease electron – attracting power down the group from fluorine to astatine.

Fluorine is the most electronegative element in the periodic table because it has the small atomic radius.

#### Electron affinity

The minimum amount of energy required to gain/acquire an extra electron by an atom of element in its gaseous state is called **1<sup>st</sup> electron affinity**. The SI unit of electron affinity is **kilojoules per mole/kJmole<sup>-1</sup>** . Electron affinity depend on atomic radius. The higher the atomic radius, the less effective the nuclear attraction on outer energy level electrons and thus the lower the electron affinity. For halogens the 1<sup>st</sup> electron affinity decrease down the group as the

atomic radius increase and the effective nuclear attraction on outer energy level electrons decrease. Due to its small size/atomic radius Fluorine shows exceptionally low electron affinity. This is because a lot of energy is required to overcome the high repulsion of the existing and incoming electrons.

Table showing the electron affinity of halogens for the process



Halogen	F	Cl	Br	I
Electron affinity $\text{kJmol}^{-1}$	-333	-364	-342	-295

The higher the electron affinity the more stable the ion. i.e.  $\text{Cl}^-$  is a more stable ion than  $\text{Br}^-$  because it has a more negative / exothermic electron affinity than  $\text{Br}^-$

Electron affinity is different from:

(i) Ionization energy.

Ionization energy is the energy required to lose/donate an electron in an atom of an element in its gaseous state while electron affinity is the energy required to gain/acquire extra electron by an atom of an element in its gaseous state.

(ii) Electronegativity.

-Electron affinity is the energy required to gain an electron in an atom of an element in gaseous state. It involves the process:



Electronegativity is the ease/tendency of gaining/ acquiring electrons by an element during chemical reactions.

It does not involve use of energy but theoretical arbitrary Pauling's scale of measurements.

### Physical properties

#### State at room temperature

Fluorine and Chlorine are gases, Bromine is a liquid and Iodine is a solid.

Astatine is radioactive .

All halogens exist as **diatomic** molecules bonded by strong covalent bond. Each molecule is joined to the other by weak intermolecular forces/ Van-der-waals forces.

#### Melting/Boiling point

The strength of intermolecular/Van-der-waals forces of attraction increase with increase in molecular size/atomic radius.

Iodine has therefore the largest atomic radius and thus strongest intermolecular forces to make it a solid.

Iodine sublimates when heated to form (**caution:** highly toxic/poisonous) purple vapour.

This is because Iodine molecules are held together by weak van-der-waals/intermolecular forces which require little heat energy to break.

#### Electrical conductivity

All Halogens are poor conductors of electricity because they have no free delocalized electrons.

#### Solubility in polar and non-polar solvents

All halogens are soluble in water(polar solvent).

When a boiling tube containing either chlorine gas or bromine vapour is separately inverted in a beaker containing distilled water and tetrachloromethane (non-polar solvent), the level of solution in boiling tube rises in both water and tetrachloromethane.

This is because halogen are soluble in both polar and non-polar solvents.

Solubility of halogens in water/polar solvents decrease down the group.

Solubility of halogens in non-polar solvent increase down the group.

The level of water in chlorine is higher than in bromine and the level of tetrachloromethane in chlorine is lower than in bromine.

**Caution:** Tetrachloromethane, Bromine vapour and Chlorine gas are all **highly** toxic/poisonous.

**Table showing the physical properties of Halogens**

Halogen	Formula of molecule	Electrical conductivity	Solubility in water	Melting point(°C)	Boiling point(°C)
Fluorine	F <sub>2</sub>	Poor	Insoluble/soluble in tetrachloromethane	-238	-188
Chlorine	Cl <sub>2</sub>	Poor	Insoluble/soluble in tetrachloromethane	-101	-35
Bromine	Br <sub>2</sub>	Poor	Insoluble/soluble in tetrachloromethane	7	59
Iodine	I <sub>2</sub>	Poor	Insoluble/soluble in tetrachloromethane	114	sublimes

#### Chemical properties

##### **(i)Displacement**

##### Experiment

Place separately in test tubes about 5cm<sup>3</sup> of sodium chloride, Sodium bromide and Sodium iodide solutions.

Add 5 drops of chlorine water to each test tube:

Repeat with 5 drops of bromine water instead of chlorine water

Observation**Using Chlorine water**

-Yellow colour of chlorine water fades in all test tubes except with sodium chloride.

-Coloured Solution formed.

**Using Bromine water**

Yellow colour of bromine water fades in test tubes containing sodium iodide.

-Coloured Solution formed.

Explanation

The halogens displace each other from their solution. The more electronegative displace the less electronegative from their solution.

Chlorine is more electronegative than bromine and iodine.

On adding chlorine water, bromine and Iodine are displaced from their solutions by chlorine.

Bromine is more electronegative than iodide but less than chlorine.

On adding Bromine water, iodine is displaced from its solution but not chlorine.

**Table showing the displacement of the halogens**

(V) means there is displacement (x) means there is no displacement

Halogen ion in solution Halogen	F <sup>-</sup>	Cl <sup>-</sup>	Br <sup>-</sup>	I <sup>-</sup>
F <sub>2</sub>	X			
Cl <sub>2</sub>	X	X		
Br <sub>2</sub>	X	X	X	
I <sub>2</sub>	X	X	X	X

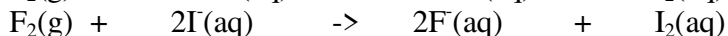
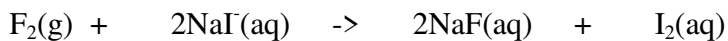
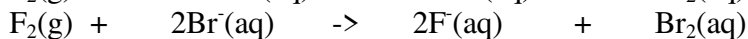
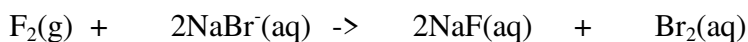
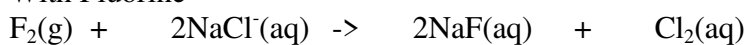
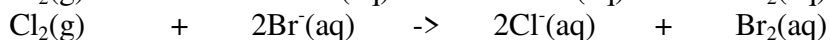
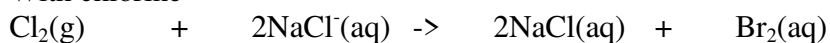
**Chemical /ionic equations****With Fluorine****With chlorine**

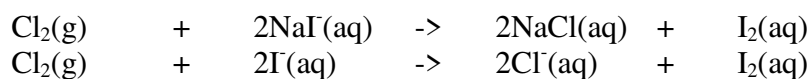

With Bromine

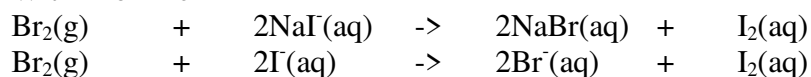

### Uses of halogens

- (i) Fluorine – manufacture of P.T.F.E (Poly tetra fluoroethene) synthetic fiber.  
- Reduce tooth decay when added in small amounts/quantities in tooth paste.

**NB** – large small quantities of fluorine /fluoride ions in water cause browning of teeth/flourosis.

- Hydrogen fluoride is used to engrave words /pictures in glass.

- (ii) Bromine - Silver bromide is used to make light sensitive photographic paper/films.

- (iii) Iodide – Iodine dissolved in alcohol is used as medicine to kill bacteria in skin cuts. It is called tincture of iodine.

The table below to show some compounds of halogens.

Element Halogen	H	Na	Mg	Al	Si	C	P
F	<b>HF</b>	<b>NaF</b>	<b>MgH<sub>2</sub></b>	<b>AlF<sub>3</sub></b>	<b>SiF<sub>4</sub></b>	<b>CF<sub>4</sub></b>	<b>PF<sub>3</sub></b>
Cl	<b>HCl</b>	<b>NaCl</b>	<b>MgCl</b>	<b>AlCl<sub>3</sub></b>	<b>SiCl<sub>3</sub></b>	<b>CCl<sub>4</sub></b>	<b>PCl<sub>3</sub></b>
Br	<b>HBr</b>	<b>NaBr</b>	<b>MgBr<sub>2</sub></b>	<b>AlBr<sub>3</sub></b>	<b>SiBr<sub>4</sub></b>	<b>CBr<sub>4</sub></b>	<b>PBr<sub>3</sub></b>
I	<b>HI</b>	<b>NaI</b>	<b>MgI<sub>2</sub></b>	<b>AlI<sub>3</sub></b>	<b>SiI<sub>4</sub></b>	<b>Cl<sub>2</sub></b>	<b>PBr<sub>3</sub></b>

(i)  
Below  
is  
the  
tabl

e showing the bond energy of four halogens.

Bond	Bond energy k J mole <sup>-1</sup>
Cl-Cl	242
Br-Br	193
I-I	151

I. What do you understand by the term “bond energy”

**Bond energy is the energy required to break/ form one mole of chemical bond**

II. Explain the trend in bond Energy of the halogens above:

**-Decrease down the group from chlorine to Iodine**

**-Atomic radius increase down the group decreasing the energy required to break the covalent bonds between the larger atom with reduced effective nuclear @ charge an outer energy level that take part in bonding.**

(c)Group VIII elements: Noble gases

Group VIII elements are called **Noble gases**. They are all non metals. Noble gases occupy about 1.0% of the atmosphere as colourless gaseous mixture.

Argon is the most abundant with 0.9%.

They exists as **monatomic** molecules with very weak van-der-waals /intermolecular forces holding the molecules.

They include:

Element	Symbol	Atomic number	Electron structure	State at room temperature
Helium	He	2	2:	Colourless gas
Neon	Ne	10	2:8	Colourless gas
Argon	Ar	18	2:8:8	Colourless gas
Krypton	Kr	36	2:8:18:8	Colourless gas
Xenon	Xe	54	2:8:18:18:8	Colourless gas
Radon	Rn	86	2:8:18:32:18:8	Radioactive

All noble gas atoms have a stable duplet(two electrons in the 1<sup>st</sup> energy level) or octet(eight electrons in other outer energy level)in the outer energy level. They therefore **do not** acquire/gain extra electron in the outer energy level or donate/lose. They therefore are therefore **zerovalent** .

The number of energy levels increases down the group from Helium to Randon. The more the number of energy levels the bigger/larger the atomic size/radius. e.g.

The atomic size/radius of Argon is bigger/larger than that of Neon because Argon has more/3 energy levels than Neon (2 energy levels).

Atomic radius noble gases increase down the group as the number of energy levels increases.

The effective nuclear attraction on the outer electrons thus decrease down the group.

The noble gases are generally unreactive because the outer energy level has the stable octet/duplet. The stable octet/duplet in noble gas atoms lead to a

comparatively very high 1<sup>st</sup> ionization energy. This is because losing /donating an electron from the stable atom require a lot of energy to lose/donate and make it unstable.

As atomic radius increase down the group and the 1<sup>st</sup> ionization energy decrease, very electronegative elements like Oxygen and Fluorine are able to react and bond with lower members of the noble gases.e.g

Xenon reacts with Fluorine to form a covalent compound XeF<sub>6</sub>.This is because the outer electrons/energy level if Xenon is far from the nucleus and thus experience less effective nuclear attraction.

Noble gases have low melting and boiling points. This is because they exist as monatomic molecules joined by very weak intermolecular/van-der-waals forces that require very little energy to weaken and form liquid and break to form a gas.

The intermolecular/van-der-waals forces increase down the group as the atomic radius/size increase from Helium to Radon. The melting and boiling points thus increase also down the group.

Noble gases are insoluble in water and are poor conductors of electricity.

Element	Formula of molecule	Electrical conductivity	Solubility in water	Atomic radius(nM)	1 <sup>st</sup> ionization energy	Melting point( <sup>0</sup> C)	Boiling point( <sup>0</sup> C)
Helium	He	Poor	Insoluble	0.128	2372	-270	-269
Neon	Ne	Poor	Insoluble	0.160	2080	-249	-246
Argon	Ar	Poor	Insoluble	0.192	1520	-189	-186
Krypton	Kr	Poor	Insoluble	0.197	1350	-157	-152
Xenon	Xe	Poor	Insoluble	0.217	1170	-112	-108
Radon	Rn	Poor	Insoluble	0.221	1134	-104	-93

#### Uses of noble gases

Argon is used in light bulbs to provide an inert environment to prevent oxidation of the bulb filament

Argon is used in arch welding as an insulator.

Neon is used in street and advertisement light

Helium is mixed with Oxygen during deep sea diving and mountaineering.

Helium is used in weather balloon for meteorological research instead of Hydrogen because it is unreactive/inert.Hydrogen when impure can ignite with an explosion.

Helium is used in making thermometers for measuring very low temperatures.



**C. PERIODICITY OF ACROSS THE PERIOD.**  
(See Chemical bonding and Structure)

## PERIODICITY OF CHEMICAL FAMILIES

### (Patterns down the group)

The number of valence electrons and the number of occupied energy levels in an atom of an element determine the position of an element in the periodic table. i.e. The number of occupied energy levels determine the Period and the valence electrons determine the Group.

Elements in the same group have similar physical and chemical properties. The trends in physical and chemical properties of elements in the same group vary down the group. Elements in the same group thus constitute a chemical family.

#### (a) Group I elements: Alkali metals

Group I elements are called **Alkali metals** except Hydrogen which is a non metal. The alkali metals include:

Element	Symbol	Atomic number	Electron structure	Oxidation state	Valency
Lithium	Li	3	2:1	Li <sup>+</sup>	1
Sodium	Na	11	2:8:1	Na <sup>+</sup>	1
Potassium	K	19	2:8:8:1	K <sup>+</sup>	1
Rubidium	Rb	37	2:8:18:8:1	Rb <sup>+</sup>	1
Caesium	Cs	55	2:8:18:18:8:1	Cs <sup>+</sup>	1
Francium	Fr	87	2:8:18:32:18:8:1	Fr <sup>+</sup>	1

All alkali metals atom has one electron in the outer energy level. They therefore are **monovalent**. They donate /lose the outer electron to have oxidation state M<sup>+</sup>. The number of energy levels increases down the group from Lithium to Francium. The more the number of energy levels the bigger/larger the atomic size. e.g. The atomic size of Potassium is bigger/larger than that of sodium because Potassium has more/4 energy levels than sodium (3 energy levels).

#### Atomic and ionic radius

The distance between the centre of the nucleus of an **atom** and the outermost energy level occupied by electron/s is called **atomic radius**. Atomic radius is measured in **nanometers**(n). The higher /bigger the atomic radius the bigger /larger the atomic size.

The distance between the centre of the nucleus of an **ion** and the outermost energy level occupied by electron/s is called **ionic radius**. Ionic radius is also measured in **nanometers(n)**. The higher /bigger the ionic radius the bigger /larger the size of the ion.

Atomic radius and ionic radius depend on the number of energy levels occupied by electrons. The more the number of energy levels the bigger/larger the atomic /ionic radius. e.g.

The atomic radius of Francium is bigger/larger than that of sodium because Francium has more/7 energy levels than sodium (3 energy levels).

Atomic radius and ionic radius of alkali metals increase down the group as the number of energy levels increases.

The atomic radius of alkali metals is bigger than the ionic radius. This is because alkali metals react by losing/donating the outer electron and hence lose the outer energy level.

### **Table showing the atomic and ionic radius of some alkali metals**

Element	Symbol	Atomic number	Atomic radius(nM)	Ionic radius(nM)
Lithium	Li	3	0.133	0.060
Sodium	Na	11	0.157	0.095
Potassium	K	19	0.203	0.133

The atomic radius of sodium is 0.157nM .The ionic radius of Na<sup>+</sup> is 0.095nM. This is because sodium reacts by donating/losing the outer electrons and hence the outer energy level. The remaining electrons/energy levels experience more effective / greater nuclear attraction/pull towards the nucleus reducing the atomic radius.

### Electropositivity

The ease of donating/losing electrons is called electropositivity. All alkali metals are electropositive. Electropositivity increase as atomic radius increase. This is because the effective nuclear attraction on outer electrons decreases with increase in atomic radius. The outer electrons experience less nuclear attraction and can be lost/ donated easily/with ease. Francium is the most electropositive element in the periodic table because it has the highest/biggest atomic radius.

### Ionization energy

The minimum amount of energy required to remove an electron from an atom of element in its gaseous state is called **1<sup>st</sup> ionization energy**. The SI unit of ionization energy is **kilojoules per mole/kJmole<sup>-1</sup>**. Ionization energy depend on atomic radius. The higher the atomic radius, the less effective the nuclear attraction on outer electrons/energy level and thus the lower the ionization energy. For alkali metals the 1<sup>st</sup> ionization energy decrease down the group as the atomic radius increase and the effective nuclear attraction on outer energy level electrons decrease.

e.g. The 1<sup>st</sup> ionization energy of sodium is 496 kJmole<sup>-1</sup> while that of potassium is 419 kJmole<sup>-1</sup>. This is because atomic radius increase and thus effective nuclear attraction on outer energy level electrons decrease down the group from sodium to Potassium. It requires therefore less energy to donate/lose outer electrons in Potassium than in sodium.

### Physical properties

**Soft/Easy to cut:** Alkali metals are soft and easy to cut with a knife. The softness and ease of cutting increase down the group from Lithium to Francium. This is because an increase in atomic radius, decreases the strength of metallic bond and the packing of the metallic structure

**Appearance:** Alkali metals have a shiny grey metallic luster when freshly cut. The surface rapidly/quickly tarnishes on exposure to air. This is because the metal surface rapidly/quickly reacts with elements of air/oxygen.

**Melting and boiling points:** Alkali metals have a relatively low melting/boiling point than common metals like Iron. This is because alkali metals use only one delocalized electron to form a weak metallic bond/structure.

**Electrical/thermal conductivity:** Alkali metals are good thermal and electrical conductors. Metals conduct using the outer mobile delocalized electrons. The delocalized electrons move randomly within the metallic structure.

### Summary of some physical properties of the 1<sup>st</sup> three alkali metals

Alkali metal	Appearance	Ease of cutting	Melting point (°C)	Boiling point (°C)	Conductivity	1 <sup>st</sup> ionization energy
Lithium	Silvery white	Not easy	180	1330	Good	520
Sodium	Shiny grey	Easy	98	890	Good	496
Potassium	Shiny grey	Very easy	64	774	Good	419

## Chemical properties

### **(i) Reaction with air/oxygen**

On exposure to air, alkali metals reacts with the elements in the air.

Example

On exposure to air, Sodium first reacts with Oxygen to form sodium oxide.

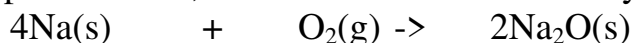

The sodium oxide formed further reacts with water/moisture in the air to form sodium hydroxide solution.

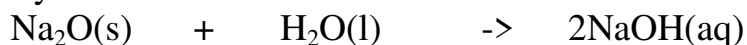

Sodium hydroxide solution reacts with carbon(IV)oxide in the air to form sodium carbonate.



### **(ii) Burning in air/oxygen**

Lithium burns in air with a **crimson**/deep red flame to form Lithium oxide

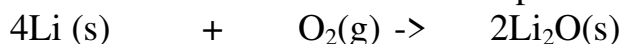

Sodium burns in air with a **yellow** flame to form sodium oxide

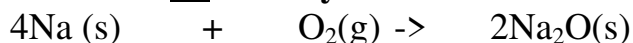

Sodium burns in oxygen with a **yellow** flame to form sodium peroxide

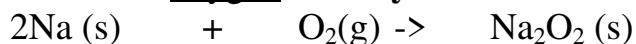

Potassium burns in air with a **lilac/purple** flame to form potassium oxide

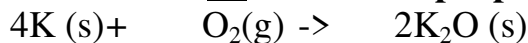

### **(iii) Reaction with water:**

#### Experiment

Measure 500 cm<sup>3</sup> of water into a beaker.

Put three drops of phenolphthalein indicator.

Put about 0.5g of Lithium metal into the beaker.

Determine the pH of final product

Repeat the experiment using about 0.1 g of Sodium and Potassium.

**Caution:** Keep a distance

#### Observations

Alkali metal	Observations	Comparative speed/rate of the reaction
Lithium	-Metal floats in water -rapid effervescence/fizzing/bubbling -colourless gas produced (that extinguishes burning splint with explosion /“pop” sound) -resulting solution turn phenolphthalein indicator pink -pH of solution = 12/13/14	Moderately vigorous
Sodium	-Metal floats in water -very rapid effervescence /fizzing /bubbling -colourless gas produced (that extinguishes burning splint with explosion /“pop” sound) -resulting solution turn phenolphthalein indicator pink -pH of solution = 12/13/14	Very vigorous
Potassium	-Metal floats in water -explosive effervescence /fizzing /bubbling -colourless gas produced (that extinguishes burning splint with explosion /“pop” sound) -resulting solution turn phenolphthalein indicator pink -pH of solution = 12/13/14	Explosive/burst into flames

### Explanation

Alkali metals are less dense than water. They therefore float in water. They react with water to form a strongly alkaline solution of their hydroxides and producing hydrogen gas. The rate of this reaction increase down the group. i.e. Potassium is more reactive than sodium .Sodium is more reactive than Lithium.

The reactivity increases as electropositivity increases of the alkali increases. This is because as the atomic radius increases , the ease of donating/losing outer electron increase during chemical reactions.

### Chemical equations

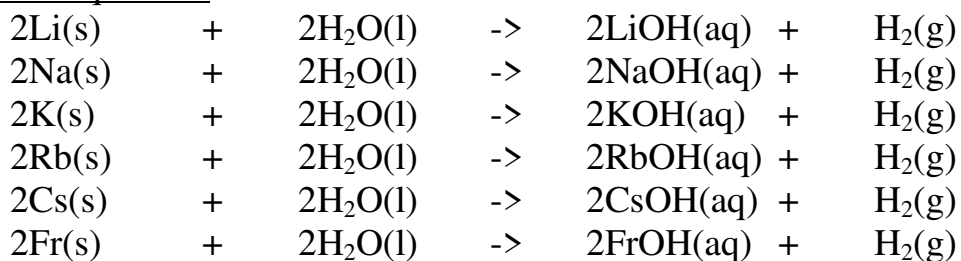

Reactivity increase down the group 

### **(iv) Reaction with chlorine:**

#### Experiment

Cut about 0.5g of sodium into a deflagrating spoon with a lid cover. Introduce it on a Bunsen flame until it catches fire. Quickly and carefully lower it into a gas jar containing dry chlorine to cover the gas jar.

Repeat with about 0.5g of Lithium.

**Caution:** This experiment should be done in fume chamber because chlorine is poisonous /toxic.

#### Observation

Sodium metal continues to burn with a yellow flame forming white solid/fumes.

Lithium metal continues to burn with a crimson flame forming white solid / fumes.

Alkali metal react with chlorine gas to form the corresponding metal chlorides. The reactivity increase as electropositivity increase down the group from Lithium to Francium. The ease of donating/losing the outer electrons increase as the atomic radius increase and the outer electron is less attracted to the nucleus.

### Chemical equations

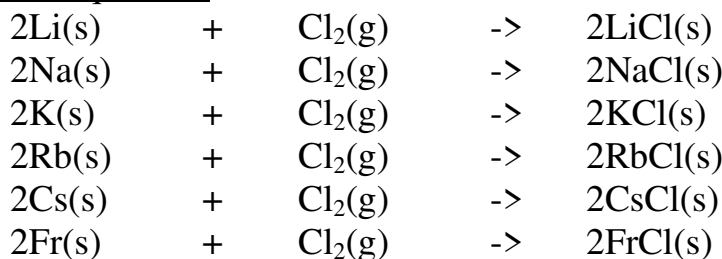

Reactivity increase down the group 

The table below shows some compounds of the 1<sup>st</sup> three alkali metals

	Lithium	sodium	Potassium
Hydroxide	LiOH	NaOH	KOH
Oxide	Li <sub>2</sub> O	Na <sub>2</sub> O	K <sub>2</sub> O
Sulphide	Li <sub>2</sub> S	Na <sub>2</sub> S	K <sub>2</sub> S
Chloride	LiCl	NaCl	KCl
Carbonate	Li <sub>2</sub> CO <sub>3</sub>	Na <sub>2</sub> CO <sub>3</sub>	K <sub>2</sub> CO <sub>3</sub>
Nitrate(V)	LiNO <sub>3</sub>	NaNO <sub>3</sub>	KNO <sub>3</sub>
Nitrate(III)	-	NaNO <sub>2</sub>	KNO <sub>2</sub>
Sulphate(VI)	Li <sub>2</sub> SO <sub>4</sub>	Na <sub>2</sub> SO <sub>4</sub>	K <sub>2</sub> SO <sub>4</sub>
Sulphate(IV)	-	Na <sub>2</sub> SO <sub>3</sub>	K <sub>2</sub> SO <sub>3</sub>
Hydrogen carbonate	-	NaHCO <sub>3</sub>	KHCO <sub>3</sub>
Hydrogen sulphate(VI)	-	NaHSO <sub>4</sub>	KHSO <sub>4</sub>
Hydrogen sulphate(IV)	-	NaHSO <sub>3</sub>	KHSO <sub>3</sub>
Phosphate	-	Na <sub>3</sub> PO <sub>4</sub>	K <sub>3</sub> PO <sub>4</sub>
Manganate(VI)	-	NaMnO <sub>4</sub>	KMnO <sub>4</sub>
Dichromate(VI)	-	Na <sub>2</sub> Cr <sub>2</sub> O <sub>7</sub>	K <sub>2</sub> Cr <sub>2</sub> O <sub>7</sub>
Chromate(VI)	-	Na <sub>2</sub> CrO <sub>4</sub>	K <sub>2</sub> CrO <sub>4</sub>

Some **uses** of alkali metals include:

- (i) Sodium is used in making sodium cyanide for extracting gold from gold ore.
- (ii) Sodium chloride is used in seasoning food.
- (iii) Molten mixture of sodium and potassium is used as coolant in nuclear reactors.
- (iv) Sodium is used in making sodium hydroxide used in making soapy and soapless detergents.
- (v) Sodium is used as a reducing agent for the extraction of titanium from Titanium(IV)chloride.
- (vi) Lithium is used in making special high strength glasses
- (vii) Lithium compounds are used to make dry cells in mobile phones and computer laptops.

Group II elements: Alkaline earth metals

Group II elements are called **Alkaline earth metals** . The alkaline earth metals include:



Element	Symbol	Atomic number	Electron structure	Oxidation state	Valency
Beryllium	Be	4	2:2	Be <sup>2+</sup>	2
Magnesium	Mg	12	2:8:2	Mg <sup>2+</sup>	2
Calcium	Ca	20	2:8:8:2	Ca <sup>2+</sup>	2
Strontium	Sr	38	2:8:18:8:2	Sr <sup>2+</sup>	2
Barium	Ba	56	2:8:18:18:8:2	Ba <sup>2+</sup>	2
Radium	Ra	88	2:8:18:32:18:8:2	Ra <sup>2+</sup>	2

All alkaline earth metal atoms have two electrons in the outer energy level. They therefore are **divalent**. They donate /lose the two outer electrons to have oxidation state M<sup>2+</sup>

The number of energy levels increases down the group from Beryllium to Radium. The more the number of energy levels the bigger/larger the atomic size. e.g.

The atomic size/radius of Calcium is bigger/larger than that of Magnesium because Calcium has more/4 energy levels than Magnesium (3 energy levels).

Atomic radius and ionic radius of alkaline earth metals increase down the group as the number of energy levels increases.

The atomic radius of alkaline earth metals is bigger than the ionic radius. This is because they react by losing/donating the two outer electrons and hence lose the outer energy level.

**Table showing the atomic and ionic radius of the 1<sup>st</sup> three alkaline earth metals**

Element	Symbol	Atomic number	Atomic radius(nM)	Ionic radius(nM)
Beryllium	Be	4	0.089	0.031
Magnesium	Mg	12	0.136	0.065
Calcium	Ca	20	0.174	0.099

The atomic radius of Magnesium is 0.136nM .The ionic radius of Mg<sup>2+</sup> is 0.065nM. This is because Magnesium reacts by donating/losing the two outer electrons and hence the outer energy level. The remaining electrons/energy levels experience more effective / greater nuclear attraction/pull towards the nucleus reducing the atomic radius.

### Electropositivity

All alkaline earth metals are also electropositive like alkali metals. The electropositivity increase with increase in atomic radius/size. Calcium is more electropositive than Magnesium. This is because the effective nuclear attraction on outer electrons decreases with increase in atomic radius. The two outer electrons in calcium experience less nuclear attraction and can be lost/ donated easily/with ease because of the higher/bigger atomic radius.

### Ionization energy

For alkaline earth metals the 1<sup>st</sup> ionization energy decrease down the group as the atomic radius increase and the effective nuclear attraction on outer energy level electrons decrease.

e.g. The 1<sup>st</sup> ionization energy of Magnesium is  $900 \text{ kJmole}^{-1}$  while that of Calcium is  $590 \text{ kJmole}^{-1}$ . This is because atomic radius increase and thus effective nuclear attraction on outer energy level electrons decrease down the group from magnesium to calcium.

It requires therefore less energy to donate/lose outer electron in calcium than in magnesium.

The minimum amount of energy required to remove a second electron from an ion of an element in its gaseous state is called the **2<sup>nd</sup> ionization energy**.

The 2<sup>nd</sup> ionization energy is always higher /bigger than the 1<sup>st</sup> ionization energy. This because once an electron is donated /lost form an atom, the overall effective nuclear attraction on the remaining electrons/energy level increase. Removing a second electron from the ion require therefore more energy than the first electron. The atomic radius of alkali metals is higher/bigger than that of alkaline earth metals. This is because across/along the period from left to right there is an increase in nuclear charge from additional number of protons and still additional number of electrons entering the same energy level. Increase in nuclear charge increases the effective nuclear attraction on the outer energy level which pulls it closer to the nucleus. e.g.

Atomic radius of Sodium (0.157nM) is higher than that of Magnesium (0.137nM). This is because Magnesium has more effective nuclear attraction on the outer energy level than Sodium hence pulls outer energy level more nearer to its nucleus.

---

### Physical properties

**Soft/Easy to cut:** Alkaline earth metals are **not** soft and easy to cut with a knife like alkali metals. This is because of the decrease in atomic radius of

corresponding alkaline earth metal, increases the strength of metallic bond and the packing of the metallic structure. Alkaline earth metals are

(i) ductile (able to form wire/thin long rods)

(ii) malleable (able to be hammered into sheet/long thin plates)

(iii) have high tensile strength (able to be coiled without breaking/ not brittle/withstand stress)

**Appearance:** Alkali earth metals have a shiny grey metallic luster when their surface is freshly polished /scrubbed. The surface slowly tarnishes on exposure to air. This is because the metal surface slowly undergoes oxidation to form an oxide. This oxide layer should be removed before using the alkaline earth metals.

**Melting and boiling points:** Alkaline earth metals have a relatively high melting/boiling point than alkali metals. This is because alkali metals use only one delocalized electron to form a weaker metallic bond/structure. Alkaline earth metals use two delocalized electrons to form a stronger metallic bond /structure. The melting and boiling points decrease down the group as the atomic radius/size increase reducing the strength of metallic bond and packing of the metallic structure. e.g.

Beryllium has a melting point of 1280°C. Magnesium has a melting point of 650°C. Beryllium has a smaller atomic radius/size than magnesium. The strength of metallic bond and packing of the metallic structure is thus stronger in beryllium.

**Electrical/thermal conductivity:** Alkaline earth metals are good thermal and electrical conductors. The two delocalized valence electrons move randomly within the metallic structure.

Electrical conductivity increase down the group as the atomic radius/size increase making the delocalized outer electrons less attracted to nucleus. Alkaline earth metals are better thermal and electrical conductors than alkali metals because they have more/two outer delocalized electrons.e.g.

---

Magnesium is a better conductor than sodium because it has more/two delocalized electrons than sodium. The more delocalized electrons the better the electrical conductor.

Calcium is a better conductor than magnesium.

---

Calcium has bigger/larger atomic radius than magnesium because the delocalized electrons are less attracted to the nucleus of calcium and thus more free /mobile and thus better the electrical conductor

---

**Summary of some physical properties of the 1<sup>st</sup> three alkaline earth metals**

Alkaline earth metal	Appearance	Ease of cutting	Melting point (°C)	Boiling point (°C)	Conductivity	1 <sup>st</sup> ionization energy	2 <sup>nd</sup> ionization energy
Beryllium	Shiny grey	Not easy	1280	3450	Good	900	1800
Magnesium	Shiny grey	Not Easy	650	1110	Good	736	1450
calcium	Shiny grey	Not easy	850	1140	Good	590	970

### Chemical properties

#### **(i)Reaction with air/oxygen**

On exposure to air, the surface of alkaline earth metals is slowly oxidized to its oxide on prolonged exposure to air.

Example

On exposure to air, the surface of magnesium ribbon is oxidized to form a thin film of Magnesium oxide



#### **(ii)Burning in air/oxygen**

##### Experiment

Hold a about 2cm length of Magnesium ribbon on a Bunsen flame. Stop heating when it catches fire/start burning.

**Caution:** Do not look directly at the flame

Put the products of burning into 100cm<sup>3</sup> beaker. Add about 5cm<sup>3</sup> of distilled water. Swirl. Test the mixture using litmus papers.

Repeat with Calcium

##### Observations

- Magnesium burns with a bright blinding flame
- White solid /ash produced
- Solid dissolves in water to form a colourless solution
- Blue litmus paper remain blue
- Red litmus paper turns blue
- colourless gas with pungent smell of urine

##### Explanation

Magnesium burns in air with a bright blinding flame to form a mixture of Magnesium oxide and Magnesium nitride.

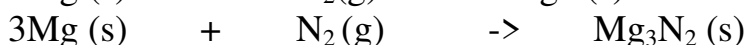
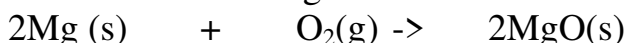

Magnesium oxide dissolves in water to form magnesium hydroxide.

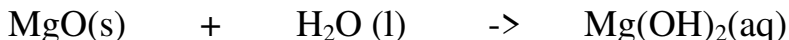

Magnesium nitride dissolves in water to form magnesium hydroxide and produce ammonia gas.

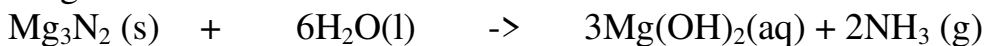

Magnesium hydroxide and ammonia are weakly alkaline with pH 8/9/10/11 and turns red litmus paper blue.

Calcium burns in air with faint orange/red flame to form a mixture of both Calcium oxide and calcium nitride.

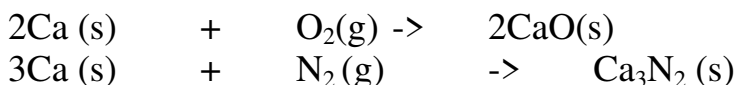

Calcium oxide dissolves in water to form calcium hydroxide.

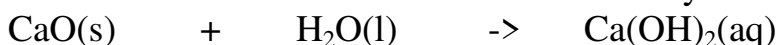

Calcium nitride dissolves in water to form calcium hydroxide and produce ammonia gas.

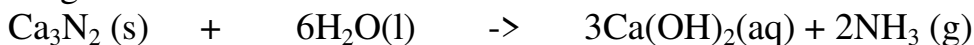

Calcium hydroxide is also weakly alkaline solution with pH 8/9/10/11 and turns red litmus paper blue.

### **(iii) Reaction with water**

#### Experiment

Measure 50 cm<sup>3</sup> of distilled water into a beaker.

Scrub/polish with sand paper 1cm length of Magnesium ribbon

Place it in the water. Test the product-mixture with blue and red litmus papers.

Repeat with Calcium metal.

#### Observations

-Surface of magnesium covered by bubbles of colourless gas.

-Colourless solution formed.

-Effervescence/bubbles/fizzing takes place in Calcium.

-Red litmus paper turns blue.

-Blue litmus paper remains blue.

#### Explanations

Magnesium slowly reacts with cold water to form Magnesium hydroxide and bubbles of Hydrogen gas that stick on the surface of the ribbon.



Calcium moderately reacts with cold water to form Calcium hydroxide and produce a steady stream of Hydrogen gas.

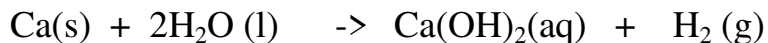

#### (iv) Reaction with water vapour/steam

##### Experiment

Put some cotton wool soaked in water/wet sand in a long boiling tube.

Coil a well polished magnesium ribbon into the boiling tube.

Ensure the coil touches the side of the boiling tube. Heat the cotton wool/sand slightly then strongly heat the Magnesium ribbon .

##### Set up of apparatus

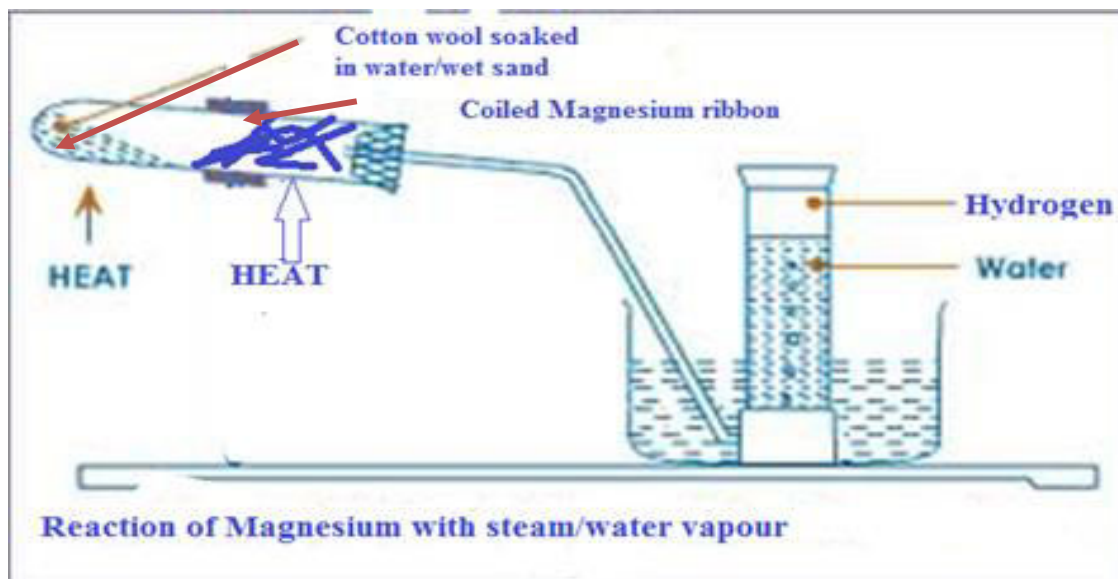

##### Observations

- Magnesium glows red hot then burns with a blinding flame.
- Magnesium continues to glow/burning even without more heating.
- White solid/residue.
- colourless gas collected over water.

##### Explanation

On heating wet sand, steam is generated which drives out the air that would otherwise react with /oxidize the ribbon.

Magnesium burns in steam/water vapour generating enough heat that ensures the reaction goes to completion even without further heating. White Magnesium oxide is formed and hydrogen gas is evolved.

To prevent suck back, the delivery tube should be removed from the water before heating is stopped at the end of the experiment.

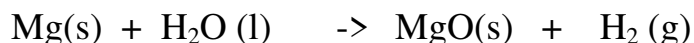

### **(v)Reaction with chlorine gas.**

#### Experiment

Lower slowly a burning magnesium ribbon/shavings into a gas jar containing Chlorine gas. Repeat with a hot piece of calcium metal.

#### Observation

- Magnesium continues to burn in chlorine with a bright blinding flame.
- Calcium continues to burn for a short time.
- White solid formed .
- Pale green colour of chlorine fades.

#### Explanation

Magnesium continues to burn in chlorine gas forming white magnesium oxide solid.

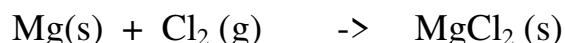

Calcium burns slightly in chlorine gas to form white calcium oxide solid. Calcium oxide formed coat unreacted Calcium stopping further reaction



### **(v)Reaction with dilute acids.**

#### Experiment

Place about 4.0cm<sup>3</sup> of 0.1M dilute sulphuric(VI)acid into a test tube. Add about 1.0cm length of magnesium ribbon into the test tube. Cover the mouth of the test tube using a thumb. Release the gas and test the gas using a burning splint.

Repeat with about 4.0cm<sup>3</sup> of 0.1M dilute hydrochloric/nitric(V) acid.

Repeat with 0.1g of Calcium in a beaker with all the above acid

**Caution:** Keep distance when using calcium

#### Observation

- Effervescence/fizzing/bubbles with dilute sulphuric(VI) and nitric(V) acids
- Little Effervescence/fizzing/bubbles with calcium and dilute sulphuric(VI) acid.
- Colourless gas produced that extinguishes a burning splint with an explosion/“pop” sound.
- No gas is produced with Nitric(V)acid.
- Colourless solution is formed.

#### Explanation

Dilute acids react with alkaline earth metals to form a salt and produce hydrogen gas.

Nitric(V)acid is a strong oxidizing agent. It quickly oxidizes the hydrogen produced to water.

Calcium is very reactive with dilute acids and thus a very **small** piece of very **dilute** acid should be used.

#### Chemical equations

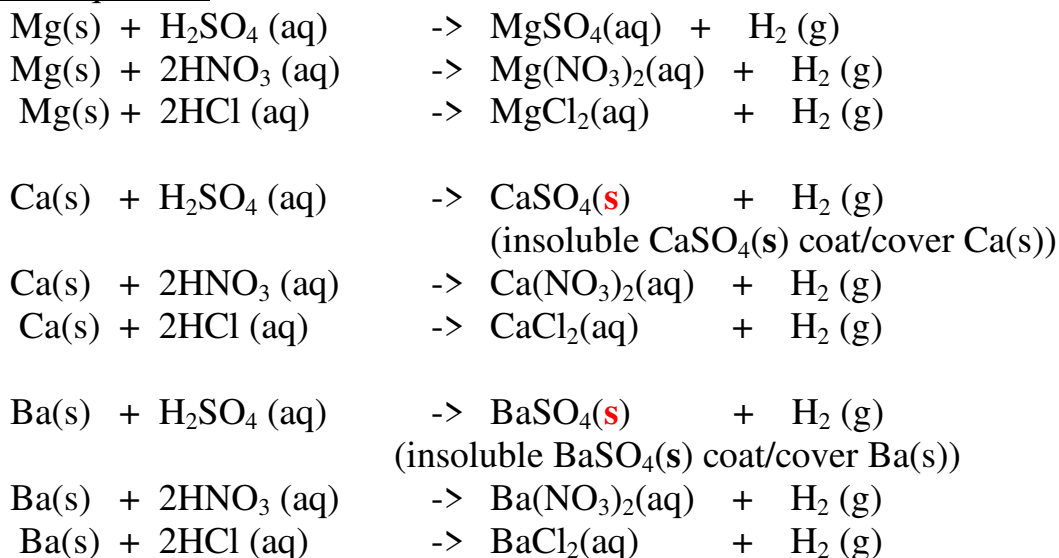

The table below shows some compounds of some alkaline earth metals

	Beryllium	Magnesium	Calcium	Barium
Hydroxide	Be(OH) <sub>2</sub>	Mg(OH) <sub>2</sub>	Ca(OH) <sub>2</sub>	Ba(OH) <sub>2</sub>
Oxide	BeO	MgO	CaO	BaO
Sulphide	-	MgS	CaS	BaS
Chloride	BeCl <sub>2</sub>	MgCl <sub>2</sub>	CaCl <sub>2</sub>	BaCl <sub>2</sub>
Carbonate	BeCO <sub>3</sub>	MgCO <sub>3</sub>	CaCO <sub>3</sub>	BaCO <sub>3</sub>
Nitrate(V)	Be(NO <sub>3</sub> ) <sub>2</sub>	Mg(NO <sub>3</sub> ) <sub>2</sub>	Ca(NO <sub>3</sub> ) <sub>2</sub>	Ba(NO <sub>3</sub> ) <sub>2</sub>
Sulphate(VI)	BeSO <sub>4</sub>	MgSO <sub>4</sub>	CaSO <sub>4</sub>	BaSO <sub>4</sub>
Sulphate(IV)	-	-	CaSO <sub>3</sub>	BaSO <sub>3</sub>
Hydrogen carbonate	-	Mg(HCO <sub>3</sub> ) <sub>2</sub>	Ca(HCO <sub>3</sub> ) <sub>2</sub>	-
Hydrogen sulphate(VI)	-	Mg(HSO <sub>4</sub> ) <sub>2</sub>	Ca(HSO <sub>4</sub> ) <sub>2</sub>	-

Some uses of alkaline earth metals include:

(i) Magnesium hydroxide is a non-toxic/poisonous mild base used as an anti acid medicine to relieve stomach acidity.

(ii) Making **duralumin**. Duralumin is an alloy of Magnesium and aluminium used for making aeroplane bodies because it is light.



- (iii) Making plaster of Paris-Calcium sulphate(VI) is used in hospitals to set a fractures bone.
- (iii) Making cement-Calcium carbonate is mixed with clay and sand then heated to form cement for construction/building.
- (iv) Raise soil pH-Quicklime/calcium oxide is added to acidic soils to neutralize and raise the soil pH in agricultural farms.
- (v) As nitrogenous fertilizer-Calcium nitrate(V) is used as an agricultural fertilizer because plants require calcium for proper growth.
- (vi) In the blast furnace-Limestone is added to the blast furnace to produce more reducing agent and remove slag in the blast furnace for extraction of Iron.

### (c) Group VII elements: Halogens

Group VII elements are called **Halogens**. They are all non metals. They include:

Element	Symbol	Atomic number	Electronic configuration	Charge of ion	Valency	State at Room Temperature
<b>Fluorine</b>	<b>F</b>	<b>9</b>	<b>2:7</b>	<b>F<sup>-</sup></b>	<b>1</b>	<b>Pale yellow gas</b>
<b>Chlorine</b>	<b>Cl</b>	<b>17</b>	<b>2:8:7</b>	<b>Cl<sup>-</sup></b>	<b>1</b>	<b>Pale green gas</b>
<b>Bromine</b>	<b>Br</b>	<b>35</b>	<b>2:8:18:7</b>	<b>Br<sup>-</sup></b>	<b>1</b>	<b>Red liquid</b>
<b>Iodine</b>	<b>I</b>	<b>53</b>	<b>2:8:18:18:7</b>	<b>I<sup>-</sup></b>	<b>1</b>	<b>Grey Solid</b>
<b>Astatine</b>	<b>At</b>	<b>85</b>	<b>2:8:18:32:18:7</b>	<b>At<sup>-</sup></b>	<b>1</b>	<b>Radioactive</b>

All halogen atoms have seven electrons in the outer energy level. They **acquire/gain one** electron in the outer energy level to be stable. They therefore are therefore **monovalent**. They exist in oxidation state X<sup>-</sup>

The number of energy levels increases down the group from Fluorine to Astatine. The more the number of energy levels the bigger/larger the atomic size. e.g.

The atomic size/radius of Chlorine is bigger/larger than that of Fluorine because Chlorine has more/3 energy levels than Fluorine (2 energy levels).

Atomic radius and ionic radius of Halogens increase down the group as the number of energy levels increases.

The atomic radius of Halogens is smaller than the ionic radius. This is because they react by gaining/acquiring extra one electron in the outer energy level. The effective nuclear attraction on the more/extra electrons decreases. The incoming extra electron is also repelled causing the outer energy level to expand to reduce the repulsion and accommodate more electrons.

**Table showing the atomic and ionic radius of four Halogens**

Element	Symbol	Atomic number	Atomic radius(nM)	Ionic radius(nM)
Fluorine	F	9	0.064	0.136
Chlorine	Cl	17	0.099	0.181
Bromine	Br	35	0.114	0.195
Iodine	I	53	0.133	0.216

The atomic radius of Chlorine is 0.099nM .The ionic radius of Cl<sup>-</sup> is 0.181nM. This is because Chlorine atom/molecule reacts by gaining/acquiring extra one electrons. The more/extra electrons/energy level experience less effective nuclear attraction /pull towards the nucleus .The outer enegy level expand/increase to reduce the repulsion of the existing and incoming gained /acquired electrons.

Electronegativity

The ease of gaining/acquiring extra electrons is called electronegativity. All halogens are electronegative. Electronegativity decreases as atomic radius increase. This is because the effective nuclear attraction on outer electrons decreases with increase in atomic radius.

The outer electrons experience less nuclear attraction and thus ease of gaining/acquiring extra electrons decrease.

It is measured using Pauling’s scale.

Where Fluorine with Pauling scale 4.0 is the most electronegative element and thus the highest tendency to acquire/gain extra electron.

Table showing the electronegativity of the halogens.

Halogen	F	Cl	Br	I	At
Electronegativity (Pauling scale)	4.0	3.0	2.8	2.5	2.2

The electronegativity of the halogens decrease down the group from fluorine to Astatine. This is because atomic radius increases down the group and thus decrease electron – attracting power down the group from fluorine to astatine.

Fluorine is the most electronegative element in the periodic table because it has the small atomic radius.

### Electron affinity

The minimum amount of energy required to gain/acquire an extra electron by an atom of element in its gaseous state is called **1<sup>st</sup> electron affinity**. The SI unit of electron affinity is **kilojoules per mole/kJmole<sup>-1</sup>**. Electron affinity depend on atomic radius. The higher the atomic radius, the less effective the nuclear attraction on outer energy level electrons and thus the lower the electron affinity. For halogens the 1<sup>st</sup> electron affinity decrease down the group as the atomic radius increase and the effective nuclear attraction on outer energy level electrons decrease. Due to its small size/atomic radius Fluorine shows exceptionally low electron affinity. This is because a lot of energy is required to overcome the high repulsion of the existing and incoming electrons.

Table showing the election affinity of halogens for the process



Halogen	F	Cl	Br	I
Electron affinity kJmole <sup>-1</sup>	-333	-364	-342	-295

The higher the electron affinity the more stable the ion.i.e

Cl<sup>-</sup> is a more stable ion than Br<sup>-</sup> because it has a more negative / exothermic electron affinity than Br<sup>-</sup>

Electron affinity is different from:

(i) Ionization energy.

Ionization energy is the energy required to lose/donate an electron in an atom of an element in its gaseous state while electron affinity is the energy required to gain/acquire extra electron by an atom of an element in its gaseous state.

(ii) Electronegativity.

-Electron affinity is the energy required to gain an electron in an atom of an element in gaseous state. It involves the process:



Electronegativity is the ease/tendency of gaining/ acquiring electrons by an element during chemical reactions.

It does not involve use of energy but theoretical arbitrary Pauling' scale of measurements.

### Physical properties

#### State at room temperature

Fluorine and Chlorine are gases, Bromine is a liquid and Iodine is a solid. Astatine is radioactive .

All halogens exist as **diatomic** molecules bonded by strong covalent bond. Each molecule is joined to the other by weak intermolecular forces/ Van-der-waals forces.

#### Melting/Boiling point

The strength of intermolecular/Van-der-waals forces of attraction increase with increase in molecular size/atomic radius.

Iodine has therefore the largest atomic radius and thus strongest intermolecular forces to make it a solid.

Iodine sublimates when heated to form (**caution:** highly toxic/poisonous) purple vapour.

This is because Iodine molecules are held together by weak van-der-waals/intermolecular forces which require little heat energy to break.

#### Electrical conductivity

All Halogens are poor conductors of electricity because they have no free delocalized electrons.

#### Solubility in polar and non-polar solvents

All halogens are soluble in water(polar solvent).

When a boiling tube containing either chlorine gas or bromine vapour is separately inverted in a beaker containing distilled water and tetrachloromethane (non-polar solvent), the level of solution in boiling tube rises in both water and tetrachloromethane.

This is because halogen are soluble in both polar and non-polar solvents.

Solubility of halogens in water/polar solvents decrease down the group. Solubility of halogens in non-polar solvent increase down the group.

The level of water in chlorine is higher than in bromine and the level of tetrachloromethane in chlorine is lower than in bromine.

**Caution:** Tetrachloromethane , Bromine vapour and Chlorine gas are all **highly** toxic/poisonous.

**Table showing the physical properties of Halogens**

<b>Halogen</b>	<b>Formula of molecule</b>	<b>Electrical conductivity</b>	<b>Solubility in water</b>	<b>Melting point(°C)</b>	<b>Boiling point(°C)</b>
Fluorine	F <sub>2</sub>	Poor	Insoluble/soluble in tetrachloromethane	-238	-188
Chlorine	Cl <sub>2</sub>	Poor	Insoluble/soluble in tetrachloromethane	-101	-35
Bromine	Br <sub>2</sub>	Poor	Insoluble/soluble in tetrachloromethane	7	59
Iodine	I <sub>2</sub>	Poor	Insoluble/soluble in tetrachloromethane	114	sublimes

### Chemical properties

#### **(i)Displacement**

##### Experiment

Place separately in test tubes about 5cm<sup>3</sup> of sodium chloride, Sodium bromide and Sodium iodide solutions.

Add 5 drops of chlorine water to each test tube:

Repeat with 5 drops of bromine water instead of chlorine water

##### Observation

##### **Using Chlorine water**

-Yellow colour of chlorine water fades in all test tubes except with sodium chloride.

-Coloured Solution formed.

##### **Using Bromine water**

Yellow colour of bromine water fades in test tubes containing sodium iodide.

-Coloured Solution formed.

##### Explanation

The halogens displace each other from their solution. The more electronegative displace the less electronegative from their solution.

Chlorine is more electronegative than bromine and iodine.

On adding chlorine water, bromine and Iodine are displaced from their solutions by chlorine.

Bromine is more electronegative than iodide but less than chlorine.

On adding Bromine water, iodine is displaced from its solution but not chlorine.

**Table showing the displacement of the halogens**

(V) means there is displacement (x) means there is no displacement

Halogen ion in solution Halogen	F <sup>-</sup>	Cl <sup>-</sup>	Br <sup>-</sup>	I <sup>-</sup>
F <sub>2</sub>	X			
Cl <sub>2</sub>	X	X		
Br <sub>2</sub>	X	X	X	
I <sub>2</sub>	X	X	X	X

**Chemical /ionic equations**

**With Fluorine**

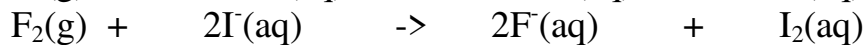
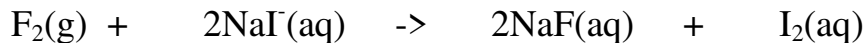
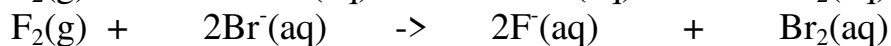
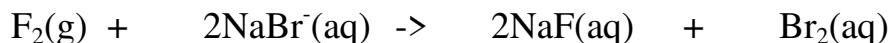
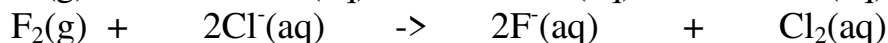

**With chlorine**

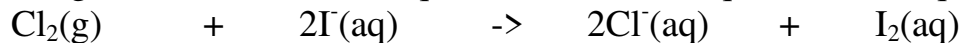
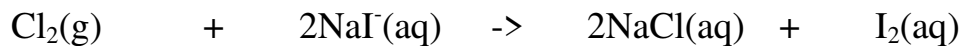
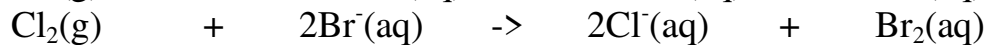
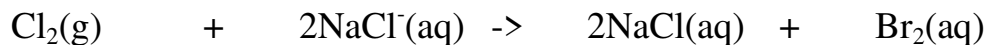

**With Bromine**

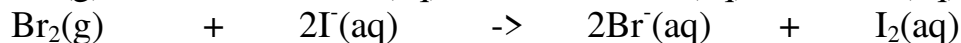
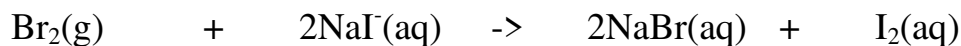

### Uses of halogens

- (i) Fluorine – manufacture of P.T.F.E (Poly tetra fluoroethene) synthetic fiber.  
 - Reduce tooth decay when added in small amounts/quantities in tooth paste.

**NB** –large small quantities of fluorine /fluoride ions in water cause browning of teeth/flourosis.

- Hydrogen fluoride is used to engrave words /pictures in glass.

- (ii) Bromine - Silver bromide is used to make light sensitive photographic paper/films.

- (iii) Iodide – Iodine dissolved in alcohol is used as medicine to kill bacteria in skin cuts. It is called tincture of iodine.

The table below to show some compounds of halogens.

Element Halogen	H	Na	Mg	Al	Si	C	P
F	<b>HF</b>	<b>NaF</b>	<b>MgF<sub>2</sub></b>	<b>AlF<sub>3</sub></b>	<b>SiF<sub>4</sub></b>	<b>CF<sub>4</sub></b>	<b>PF<sub>3</sub></b>
Cl	<b>HCl</b>	<b>NaCl</b>	<b>MgCl<sub>2</sub></b>	<b>AlCl<sub>3</sub></b>	<b>SiCl<sub>4</sub></b>	<b>CCl<sub>4</sub></b>	<b>PCl<sub>3</sub></b>
Br	<b>HBr</b>	<b>NaBr</b>	<b>MgBr<sub>2</sub></b>	<b>AlBr<sub>3</sub></b>	<b>SiBr<sub>4</sub></b>	<b>CBr<sub>4</sub></b>	<b>PBr<sub>3</sub></b>
I	<b>HI</b>	<b>NaI</b>	<b>MgI<sub>2</sub></b>	<b>AlI<sub>3</sub></b>	<b>SiI<sub>4</sub></b>	<b>CI<sub>4</sub></b>	<b>PBr<sub>3</sub></b>

(i)  
Below is the table showing

g the bond energy of four halogens.

Bond	Bond energy k J mole <sup>-1</sup>
Cl-Cl	242
Br-Br	193
I-I	151

I. What do you understand by the term “bond energy”

**Bond energy is the energy required to break/ form one mole of chemical bond**

II. Explain the trend in bond Energy of the halogens above:

**-Decrease down the group from chlorine to Iodine**

**-Atomic radius increase down the group decreasing the energy required to break the covalent bonds between the larger atom with reduced effective nuclear @ charge an outer energy level that take part in bonding.**

(c)Group VIII elements: Noble gases

Group VIII elements are called **Noble gases**. They are all non metals. Noble gases occupy about 1.0% of the atmosphere as colourless gaseous mixture. Argon is the most abundant with 0.9%.

They exists as **monatomic** molecules with very weak van-der-waals /intermolecular forces holding the molecules.

They include:

Element	Symbol	Atomic number	Electron structure	State at room temperature
Helium	He	2	2:	Colourless gas
Neon	Ne	10	2:8	Colourless gas
Argon	Ar	18	2:8:8	Colourless gas
Krypton	Kr	36	2:8:18:8	Colourless gas
Xenon	Xe	54	2:8:18:18:8	Colourless gas
Radon	Rn	86	2:8:18:32:18:8	Radioactive

All noble gas atoms have a stable duplet(two electrons in the 1<sup>st</sup> energy level) or octet(eight electrons in other outer energy level)in the outer energy level. They therefore **do not** acquire/gain extra electron in the outer energy level or donate/lose. They therefore are therefore **zerovalent** .

The number of energy levels increases down the group from Helium to Randon. The more the number of energy levels the bigger/larger the atomic size/radius. e.g.

The atomic size/radius of Argon is bigger/larger than that of Neon because Argon has more/3 energy levels than Neon (2 energy levels).

Atomic radius noble gases increase down the group as the number of energy levels increases.

The effective nuclear attraction on the outer electrons thus decrease down the group.

The noble gases are generally unreactive because the outer energy level has the stable octet/duplet. The stable octet/duplet in noble gas atoms lead to a comparatively very high 1<sup>st</sup> ionization energy. This is because losing /donating an electron from the stable atom require a lot of energy to lose/donate and make it unstable.



As atomic radius increase down the group and the 1<sup>st</sup> ionization energy decrease, very electronegative elements like Oxygen and Fluorine are able to react and bond with lower members of the noble gases.e.g

Xenon reacts with Fluorine to form a covalent compound XeF<sub>6</sub>.This is because the outer electrons/energy level if Xenon is far from the nucleus and thus experience less effective nuclear attraction.

Noble gases have low melting and boiling points. This is because they exist as monatomic molecules joined by very weak intermolecular/van-der-waals forces that require very little energy to weaken and form liquid and break to form a gas. The intermolecular/van-der-waals forces increase down the group as the atomic radius/size increase from Helium to Radon. The melting and boiling points thus increase also down the group.

Noble gases are insoluble in water and are poor conductors of electricity.

Element	Formula of molecule	Electrical conductivity	Solubility in water	Atomic radius(nM)	1 <sup>st</sup> ionization energy	Melting point( <sup>0</sup> C)	Boiling point( <sup>0</sup> C)
Helium	He	Poor	Insoluble	0.128	2372	-270	-269
Neon	Ne	Poor	Insoluble	0.160	2080	-249	-246
Argon	Ar	Poor	Insoluble	0.192	1520	-189	-186
Krypton	Kr	Poor	Insoluble	0.197	1350	-157	-152
Xenon	Xe	Poor	Insoluble	0.217	1170	-112	-108
Radon	Rn	Poor	Insoluble	0.221	1134	-104	-93

### Uses of noble gases

Argon is used in light bulbs to provide an inert environment to prevent oxidation of the bulb filament

Argon is used in arch welding as an insulator.

Neon is used in street and advertisement light

Helium is mixed with Oxygen during deep sea diving and mountaineering.

Helium is used in weather balloon for meteorological research instead of Hydrogen because it is unreactive/inert. Hydrogen when impure can ignite with an explosion.

Helium is used in making thermometers for measuring very low temperatures.

# STRUCTURE AND BONDING

## IONIC (ELECTROVALENT) BONDING

Noble gases like neon or argon have eight electrons in their outer shells (or two in the case of helium). These noble gas structures are thought of as being in some way a "desirable" thing for an atom to have. When other atoms react, they try to organise electrons such that their outer shells are either completely full or completely empty. Chemical reactions occur so that atoms attain inert gas configuration by either losing valency electrons as in the case of metals, or gaining electrons as in the case of non metals.

### Ionic bonding in sodium chloride

Sodium (2,8,1) has 1 electron more than a stable noble gas structure (2,8). If it gave away that electron it would become more stable. Chlorine (2,8,7) has 1 electron short of a stable noble gas structure (2,8,8). If it could gain an electron from somewhere it too would become more stable.

If a sodium atom gives an electron to a chlorine atom, both become more stable.

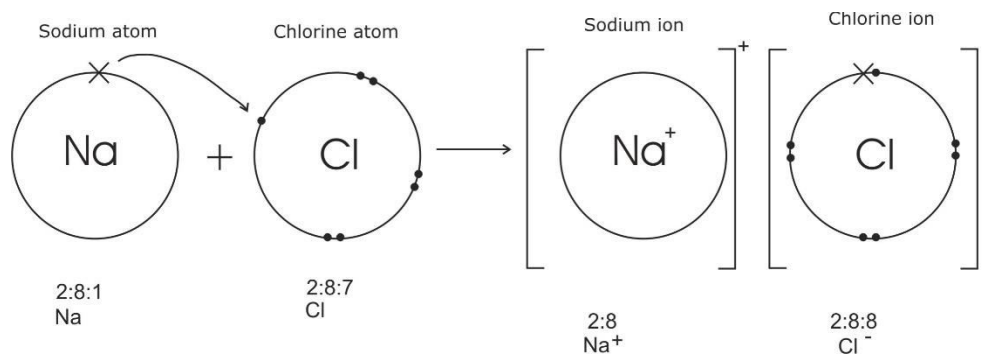
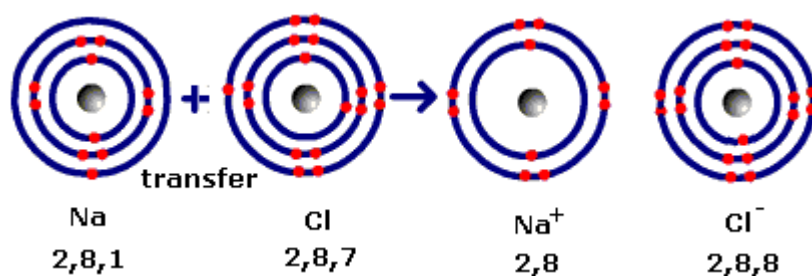
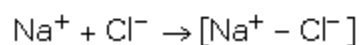
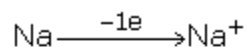

The sodium has lost an electron, so it no longer has equal numbers of electrons and protons. Because it has one more proton than electron, it has a charge of  $1+$ . If electrons are lost from an atom, positive ions are formed. Positive ions are sometimes called cations because they move to the cathode during electrolysis.

The chlorine has gained an electron, so it now has one more electron than proton. It therefore has a charge of  $1-$ . If electrons are gained by an atom, negative ions are formed. A negative ion is sometimes called an anion since it drifts to the anode during electrolysis.

### The nature of ionic bond

The sodium ions and chloride ions are held together by the strong electrostatic attractions between the positive and negative charges. You need one sodium atom to provide the extra electron for one chlorine atom, so they combine together 1:1. The formula is therefore NaCl.

### Properties of ionic compounds

- ✓ All compounds with ionic bonding produce giant ionic structures.
- ✓ Consist of oppositely charged ions arranged in an ionic lattice, the ions are held together by strong ionic bonds. e.g. NaCl is composed of  $\text{Na}^+$  ions and  $\text{Cl}^-$  ions.

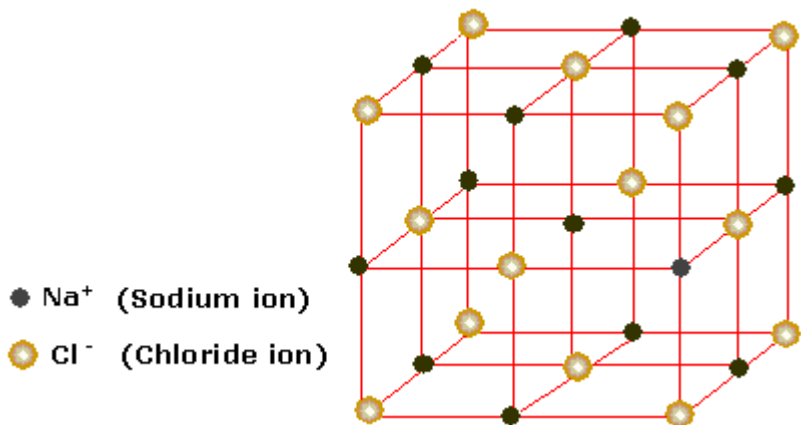

- ✓ These bonds are hard to break, therefore ionic substances have very high melting and boiling points.

- ✓ All exist as solids.
- ✓ They conduct electricity when molten, because the ions are free to move, but do not conduct when solid.
- ✓ They conduct electricity in the aqueous state because the ions are free to move.
- ✓ Most ionic substances are soluble in water because the polar water molecules can accommodate the charged ions.

## COVALENT BONDING - SINGLE BONDS

As well as achieving noble gas structures by transferring electrons from one atom to another as in ionic bonding, it is also possible for atoms to reach these stable structures by sharing electrons to give covalent bonds.

Depending on the number of electron pairs shared between atoms which participate in bonding, covalent bonds are classified as follows:

1) Single covalent bond  $\left[ \begin{array}{c} \bullet \\ \longleftrightarrow \\ \bullet \end{array} \right]$  - one pair of electrons shared.

2) Double covalent bond  $\left[ \begin{array}{c} \bullet \\ \longleftrightarrow \\ \bullet \\ \longleftrightarrow \\ \bullet \end{array} \right]$  - two pairs of electrons shared.

3) Triple covalent bond  $\left[ \begin{array}{c} \bullet \\ \longleftrightarrow \\ \bullet \\ \longleftrightarrow \\ \bullet \\ \longleftrightarrow \\ \bullet \end{array} \right]$  - three pairs of electrons shared.

Some simple covalent molecules

### Chlorine

For example, two chlorine atoms could both achieve stable structures by sharing their single unpaired electron as in the diagram. The fact that one chlorine has been drawn with electrons marked as crosses and the other as dots is simply to show where all the electrons come from. In reality there is no difference between them.

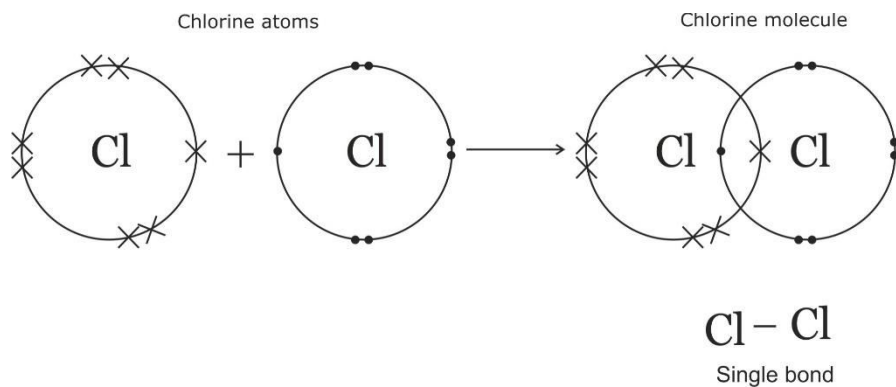

The two chlorine atoms are said to be joined by a covalent bond. The reason that the two chlorine atoms stick together is that the shared pair of electrons is attracted to the nucleus of both chlorine atoms.

### Hydrogen

Hydrogen atoms only need two electrons in their outer level to reach the noble gas structure of helium.

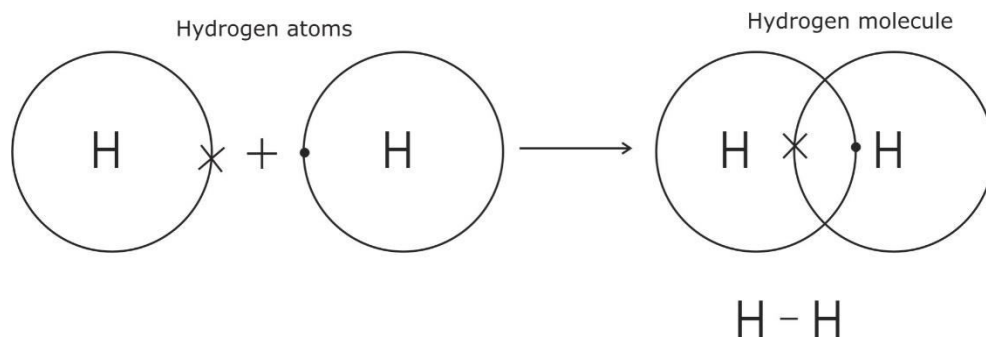

Once again, the covalent bond holds the two atoms together because the pair of electrons is attracted to both nuclei. This is another single bond.

### Hydrogen chloride

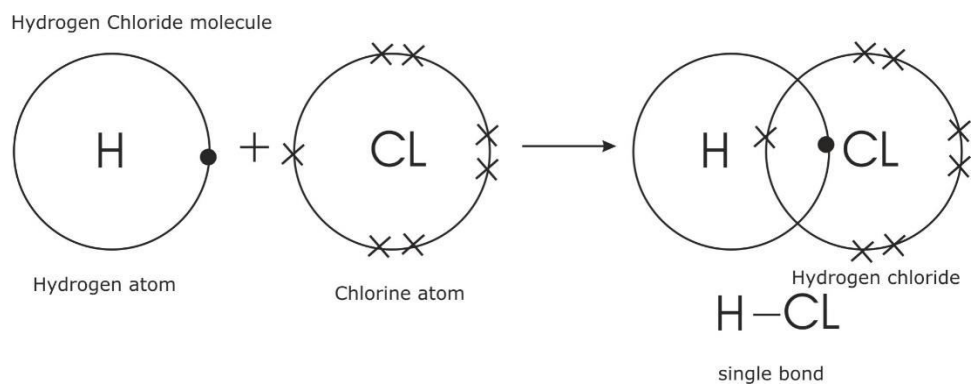

The hydrogen has a helium structure, and the chlorine an argon structure.

### Water

Oxygen atom has six electrons in the outer shell, while each of the two hydrogen atoms has one each. After bonding, oxygen has 8 electrons while each hydrogen atom has two as shown by the molecule.

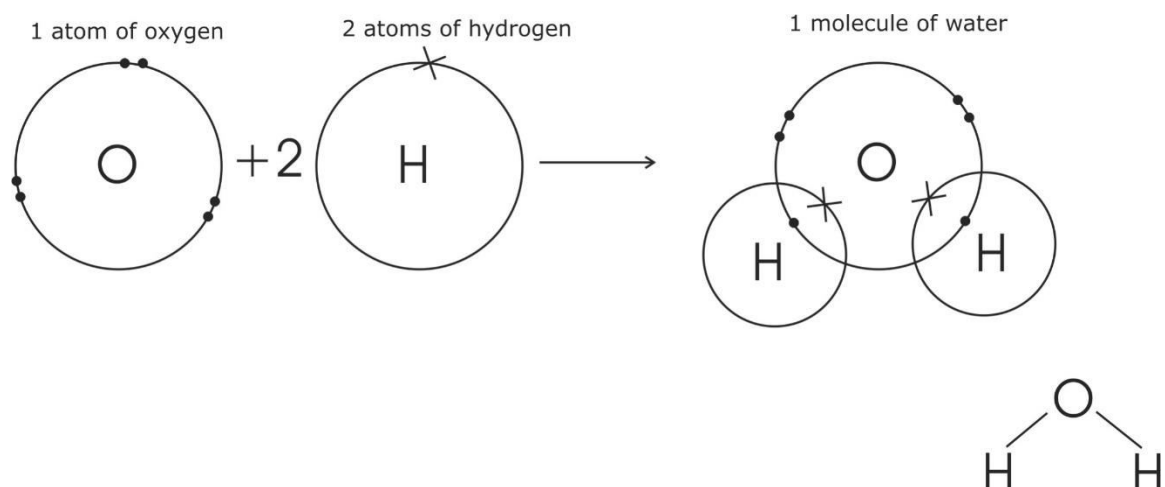

### NITROGEN GAS

Each nitrogen atom has five electrons in the outer shell. Each needs 3 electrons to complete the outer shell. In the formation of the molecule, each nitrogen atom contributes three electrons and a triple bond is formed

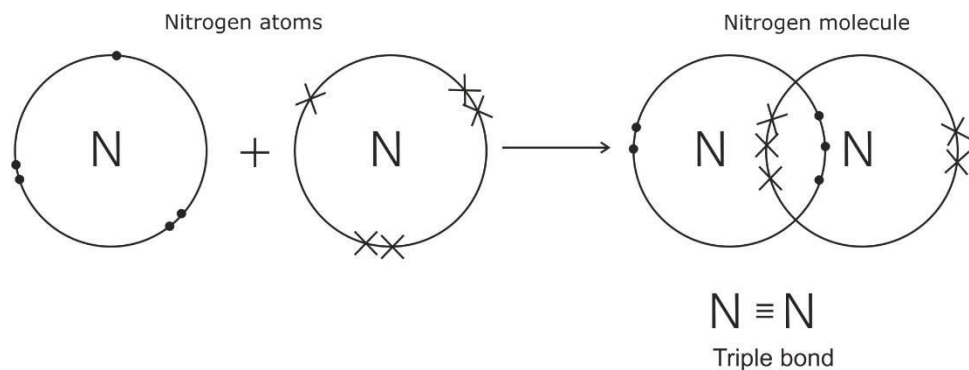

### **Characteristics of Covalent Compounds**

1) Covalent compounds consist of molecules and not ions. The molecules do not have any electric charge on them. The molecules are held together by weak forces called **Van der Waal's forces**.

2) Covalent compounds are gases, volatile liquids or soft solids. As there are weak, Van der Waal's forces between the molecules, they are not held in rigid position. The state depends on the bond energy. If the bond energy is very low, they stay as gases, if it is appreciable they are volatile liquids. If very high, they exist as soft solids.

3) Covalent compounds generally have low melting and boiling points. As Van der Waal's forces are weak, a very small amount of energy is required to break the bond between the molecules corresponding to low melting point and boiling point.

4) Covalent compounds dissolve in organic solvents. As they do not contain ions, solvation does not take place when water is added to the compound. Hence they do not dissolve in water.

5) Covalent compounds are bad conductors of electricity. They do not contain ions in the fused state, nor do ions migrate on application of an electric potential. Hence, there is no conduction of current.

6) Covalent compounds are less dense when compared to water. Very weak Van der Waal's forces hold the molecules together, hence there are large inter molecular spaces. Consequently less number of molecules per unit volume, which means mass per unit volume is also less. Hence they have a low density.

### Exceptions

- Diamond and graphite, the allotropes of carbon have high melting point.
- Hydrogen chloride in the aqueous state conducts electricity.

### The giant covalent structure of diamond

Carbon has an electronic arrangement of 2, 4. In diamond, each carbon shares electrons with four other carbon atoms - forming four single bonds.

In the diagram some carbon atoms only seem to be forming two bonds (or even one bond), but that's not really the case. We are only showing a small bit of the whole structure.

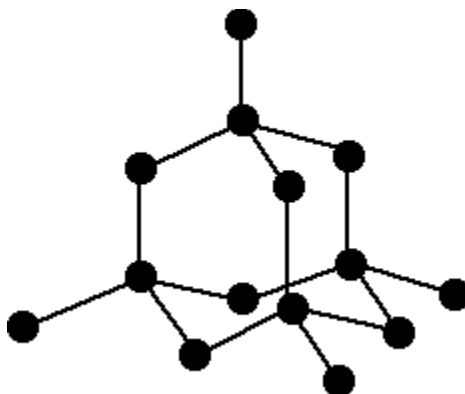

This is a giant covalent structure - it continues on and on in three dimensions. It is not a molecule, because the number of atoms joined up in a real diamond is completely variable - depending on the size of the crystal.

### The physical properties of diamond

#### Diamond

- Has a very high melting point (almost 4000°C). Very strong carbon-carbon covalent bonds have to be broken throughout the structure before melting occurs.
- Is very hard. This is again due to the need to break very strong covalent bonds operating in 3-dimensions.
- Doesn't conduct electricity. All the electrons are held tightly between the atoms, and aren't free to move.
- Is insoluble in water and organic solvents. There are no possible attractions which could occur between solvent molecules and carbon atoms which could outweigh the attractions between the covalently bound carbon atoms.

### The giant covalent structure of graphite

Graphite has a **layer structure** which is quite difficult to draw convincingly in three dimensions. The diagram below shows the arrangement of the atoms in each layer, and the way the layers are spaced.



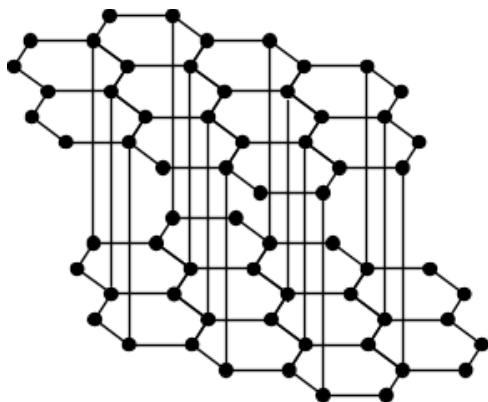

### The bonding in graphite

Each carbon atom uses three of its electrons to form simple bonds to its three close neighbours. That leaves a fourth electron in the bonding level. These "spare" electrons in each carbon atom become delocalised over the whole of the sheet of atoms in one layer. They are no longer associated directly with any particular atom or pair of atoms, but are free to wander throughout the whole sheet. The important thing is that the delocalised electrons are free to move anywhere within the sheet - each electron is no longer fixed to a particular carbon atom. There is, however, no direct contact between the delocalised electrons in one sheet and those in the neighbouring sheets.

The atoms within a sheet are held together by strong covalent bonds - stronger, in fact, than in diamond because of the additional bonding caused by the delocalised electrons. So what holds the sheets together?

In graphite you have the ultimate example of van der Waals dispersion forces. As the delocalised electrons move around in the sheet, very large temporary dipoles can be set up which will induce opposite dipoles in the sheets above and below - and so on throughout the whole graphite crystal.

### The physical properties of graphite

Graphite

- Has a high melting point, similar to that of diamond. In order to melt graphite, it isn't enough to loosen one sheet from another. You have to break the covalent bonding throughout the whole structure.

- Has a soft, slippery feel, and is used in pencils and as a dry lubricant for things like locks. You can think of graphite rather like a pack of cards - each card is strong, but the cards will slide over each other, or even fall off the pack altogether. When you use a pencil, sheets are rubbed off and stick to the paper.
- Has a lower density than diamond. This is because of the relatively large amount of space that is "wasted" between the sheets.
- Is insoluble in water and organic solvents - for the same reason that diamond is insoluble. Attractions between solvent molecules and carbon atoms will never be strong enough to overcome the strong covalent bonds in graphite.
- Conducts electricity. The delocalised electrons are free to move throughout the sheets. If a piece of graphite is connected into a circuit, electrons can fall off one end of the sheet and be replaced with new ones at the other end.

### The structure of silicon dioxide, SiO<sub>2</sub>

Silicon dioxide is also known as silicon (IV) oxide.

### The giant covalent structure of silicon dioxide

There are three different crystal forms of silicon dioxide. The easiest one to remember and draw is based on the diamond structure.

Crystalline silicon has the same structure as diamond. To turn it into silicon dioxide, all you need to do is to modify the silicon structure by including some oxygen atoms.

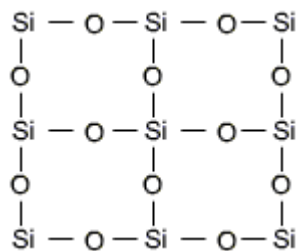
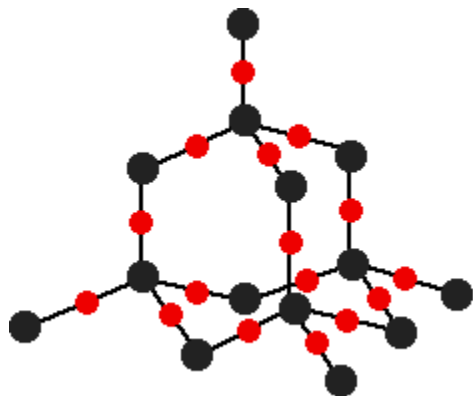

Notice that each silicon atom is bridged to its neighbours by an oxygen atom. Don't forget that this is just a tiny part of a giant structure extending on all 3 dimensions.

### The physical properties of silicon dioxide

Silicon dioxide

- Has a high melting point - varying depending on what the particular structure is (remember that the structure given is only one of three possible structures), but around 1700°C. Very strong silicon-oxygen covalent bonds have to be broken throughout the structure before melting occurs.
- Is hard. This is due to the need to break the very strong covalent bonds.
- Doesn't conduct electricity. There aren't any delocalised electrons. All the electrons are held tightly between the atoms, and aren't free to move.
- Is insoluble in water and organic solvents. There are no possible attractions which could occur between solvent molecules and the silicon or oxygen atoms which could overcome the covalent bonds in the giant structure.

### **Uses of Silica**

- i) Quartz glass is used for manufacturing optical instruments.
- ii) Colored quartz is used for manufacturing gems.
- iii) Sand is used in manufacture of glass, porcelain, sand paper and mortar etc.
- iv) Sand stone is used as a building material.

### CO-ORDINATE (DATIVE COVALENT) BONDING

#### Co-ordinate (dative covalent) bonding

A covalent bond is formed by two atoms sharing a pair of electrons. The atoms are held together because the electron pair is attracted by both of the nuclei. In the formation of a simple covalent bond, each atom supplies one electron to the bond - but that doesn't have to be the case. A co-ordinate bond (also called a

dative covalent bond) is a covalent bond (a shared pair of electrons) in which both electrons come from the same atom.

### The reaction between ammonia and hydrogen chloride

If these colourless gases are allowed to mix, a thick white smoke of solid ammonium chloride is formed. Ammonium ions,  $\text{NH}_4^+$ , are formed by the transfer of a hydrogen ion from the hydrogen chloride to the lone pair of electrons on the ammonia molecule.

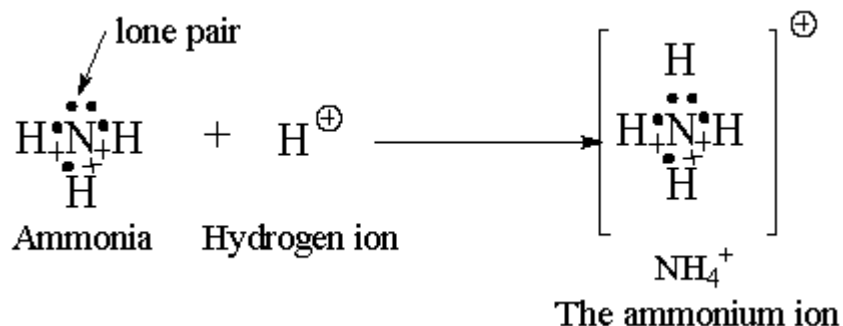

When the ammonium ion,  $\text{NH}_4^+$ , is formed, the fourth hydrogen is attached by a dative covalent bond, because only the hydrogen's nucleus is transferred from the chlorine to the nitrogen. The hydrogen's electron is left behind on the chlorine to form a negative chloride ion.

Once the ammonium ion has been formed it is impossible to tell any difference between the dative covalent and the ordinary covalent bonds. Although the electrons are shown differently in the diagram, there is no difference between them in reality.

## INTERMOLECULAR BONDING - VAN DER WAALS FORCES

### (a) VAN DER WAALS FORCES

**Intermolecular** attractions are attractions between one molecule and a neighbouring molecule. The forces of attraction which hold an individual molecule together (for example, the covalent bonds) are known as

**intramolecular** attractions. All molecules experience intermolecular attractions, although in some cases those attractions are very weak. Even in a gas like hydrogen,  $H_2$ , if you slow the molecules down by cooling the gas, the attractions are large enough for the molecules to stick together eventually to form a liquid and then a solid.

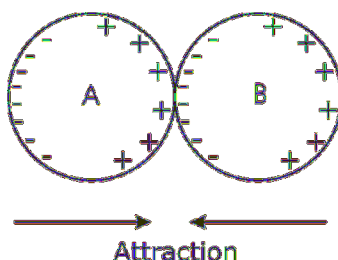

In hydrogen's case the attractions are so weak that the molecules have to be cooled to  $(-252^{\circ}C)$  before the attractions are enough to condense the hydrogen as a liquid. Helium's intermolecular attractions are even weaker - the molecules won't stick together to form a liquid until the temperature drops to  $(-269^{\circ}C)$ .

## HYDROGEN BONDING

Polar molecules, such as water molecules, have a weak, partial negative charge at one region of the molecule (the oxygen atom in water) and a partial positive charge elsewhere (the hydrogen atoms in water).

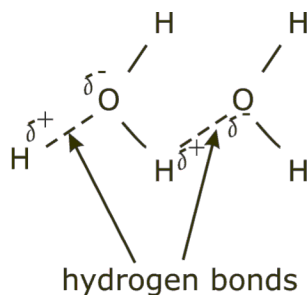

Hydrogen bonds between water molecules

Thus when water molecules are close together, their positive and negative regions are attracted to the oppositely-charged regions of nearby molecules. The force of attraction, shown here as a dotted line, is called a **hydrogen bond**. Each water molecule is hydrogen bonded to four others.

The hydrogen bonds that form between water molecules account for some of the essential — and unique — properties of water.

- The attraction created by hydrogen bonds keeps water liquid over a wider range of temperature than is found for any other molecule its size.

- The energy required to break multiple hydrogen bonds causes water to have a high heat of vaporization; that is, a large amount of energy is needed to convert liquid water, where the molecules are attracted through their hydrogen bonds, to water vapor, where they are not.

## Liquid Water and Hydrogen Bonding

### Why water is a liquid?

In many ways, water is a miracle liquid. Since the hydrogen and oxygen atoms in the molecule carry opposite (though partial) charges, nearby water molecules are attracted to each other like tiny little magnets. Hydrogen bonding makes water molecules "stick" together. This makes water have high melting and boiling points compared to other covalent compounds such as ammonia ( $\text{NH}_3$ ) which have similar molecular mass but are gases

### Ice and Hydrogen Bonding

The structure that forms in the solid ice crystal actually has large holes in it. Therefore, in a given volume of ice, there are fewer water molecules than in the same volume of liquid water. In other words, ice is less dense than liquid water and will float on the surface of the liquid.

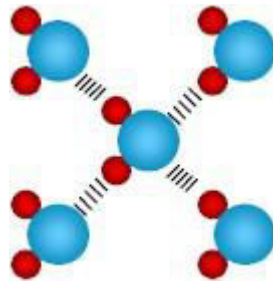

### Surface Tension and hydrogen bonding

As we just discussed, neighboring water molecules are attracted to one another. Molecules at the surface of liquid water have fewer neighbors and, as a result, have a greater attraction to the few water molecules that are nearby. This enhanced attraction is called **surface tension**. It makes the surface of the liquid slightly more difficult to break through than the interior.

## Water as a Solvent

The partial charge that develops across the water molecule helps make it an excellent solvent. Water dissolves many substances by surrounding charged particles and "pulling" them into solution. For example, common table salt, sodium chloride, is an ionic substance that contains alternating sodium and chlorine ions. When table salt is added to water, the partial charges on the water molecule are attracted to the  $\text{Na}^+$  and  $\text{Cl}^-$  ions.

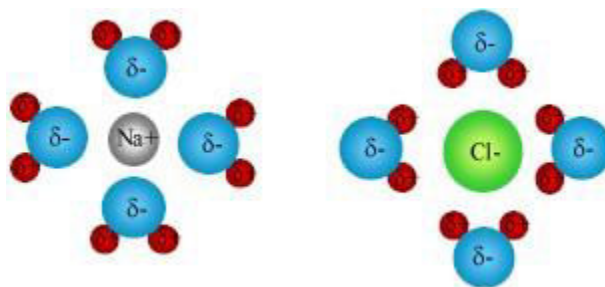

### **Why does ethanol have a higher boiling point than methoxymethane?**

Ethanol,  $\text{CH}_3\text{CH}_2\text{-O-H}$ , and methoxymethane,  $\text{CH}_3\text{-O-CH}_3$ , both have the same molecular formula,  $\text{C}_2\text{H}_6\text{O}$ .

They have the same number of electrons, and a similar length to the molecule. The van der Waals attractions (both dispersion forces and dipole-dipole attractions) in each will be much the same.

However, ethanol has a hydrogen atom attached directly to oxygen - and that oxygen still has exactly the same two lone pairs as in a water molecule. Hydrogen bonding can occur between ethanol molecules, although not as effectively as in water. The hydrogen bonding is limited by the fact that there is only one hydrogen in each ethanol molecule with sufficient  $\delta^+$  charge.

In methoxymethane, the lone pairs on the oxygen are still there, but the hydrogens aren't sufficiently  $\delta^+$  for hydrogen bonds to form. Except in some rather unusual cases, the hydrogen atom has to be attached directly to the very electronegative element for hydrogen bonding to occur.

The boiling points of ethanol and methoxymethane show the dramatic effect that the hydrogen bonding has on the stickiness of the ethanol molecules:

ethanol (with hydrogen bonding)	78.5°C
methoxymethane (without hydrogen bonding)	-24.8°C

The hydrogen bonding in the ethanol has lifted its boiling point about 100°C. It is important to realise that hydrogen bonding exists in addition to van der Waals attractions. For example, all the following molecules contain the same number of electrons, and the first two are much the same length. The higher boiling point of the butan-1-ol is due to the additional hydrogen bonding.

## 4. BONDING IN METALS

### Bonding in metals

Metal atoms have relatively few electrons in their outer shells. When they are packed together, each metal atom loses its outer electrons into a 'sea' of free electrons (or mobile electrons). Having lost electrons, the atoms are no longer electrically neutral. They become positive ions because they have lost electrons but the number of protons in the nucleus has remained unchanged.

Therefore the structure of a metal is made up of positive ions packed together. These ions are surrounded by electrons, which can move freely between the ions.

- An ion is a charged particle made from an atom by the loss or gain of electrons.
- Metal atoms most easily lose electrons, so they become positive ions. In doing so they achieve a more stable electron arrangement, usually that of the nearest noble gas.

These free electrons are **delocalized** (not restricted to orbiting one positive ion) and form a kind of electrostatic 'glue' holding the structure together. In an electrical circuit, metals can conduct electricity because the mobile electrons can move through the structure carrying charge. This type of bonding (called **metallic bonding**) is present in alloys as well. Alloys, for example solder and brass, will conduct electricity.



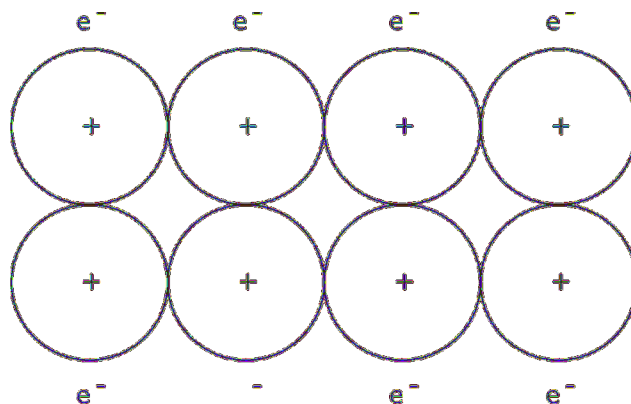

$e^-$  Free delocalised valency electron

$\oplus$  Metal ion (formed after metal loses electron)

### The physical properties of metals:

This strong bonding generally results in dense, strong materials with high melting and boiling points. Usually a relatively large amount of energy is needed to melt or boil metals.

- Metals are good conductors of electricity because these 'free' electrons carry the charge of an electric current when a potential difference (voltage!) is applied across a piece of metal.
- Metals are also good conductors of heat. This is also due to the free moving electrons. Non-metallic solids conduct heat energy by hotter more strongly vibrating atoms, knocking against cooler less strongly vibrating atoms to pass the particle kinetic energy on. In metals, as well as this effect, the 'hot' high kinetic energy electrons move around freely to transfer the particle kinetic energy more efficiently to 'cooler' atoms.
- Typical metals also have a silvery surface but remember this may be easily tarnished by corrosive oxidation in air and water.
- Unlike ionic solids, metals are very malleable, they can be readily bent, pressed or hammered into shape.

# INTRODUCTION TO SALTS

1.(a) A salt is an ionic compound formed when the cation from a base combine with the anion derived from an acid.

A salt is therefore formed when the hydrogen ions in an acid are replaced wholly/fully or partially/partly ,directly or indirectly by a metal or ammonium radical.

(b) The number of ionizable/replaceable hydrogen in an acid is called **basicity** of an acid.

Some acids are therefore:

(i)**monobasic** acids generally denoted **HX** e.g.  
**HCl, HNO<sub>3</sub>,HCOOH,CH<sub>3</sub>COOH.**

(ii)**dibasic** acids ; generally denoted **H<sub>2</sub>X** e.g.  
**H<sub>2</sub>SO<sub>4</sub>, H<sub>2</sub>SO<sub>3</sub>, H<sub>2</sub>CO<sub>3</sub>,HOOCOOH.**

(iii)**tribasic** acids ; generally denoted **H<sub>3</sub>X** e.g.  
**H<sub>3</sub>PO<sub>4</sub>.**

(c) Some salts are **normal** salts while other are **acid** salts.

(i)A normal salt is formed when all the ionizable /replaceable hydrogen in an acid is replaced by a metal or metallic /ammonium radical.

(ii)An acid salt is formed when part/portion the ionizable /replaceable hydrogen in an acid is replaced by a metal or metallic /ammonium radical.

Table showing normal and acid salts derived from common acids

Acid name	Chemical formula	Basicity	Normal salt	Acid salt
Hydrochloric acid	HCl	Monobasic	Chloride(Cl <sup>-</sup> )	None
Nitric(V)acid	HNO <sub>3</sub>	Monobasic	Nitrate(V)(NO <sub>3</sub> <sup>-</sup> )	None
Nitric(III)acid	HNO <sub>2</sub>	Monobasic	Nitrate(III)(NO <sub>2</sub> <sup>-</sup> )	None
Sulphuric(VI)acid	H <sub>2</sub> SO <sub>4</sub>	Dibasic	Sulphate(VI) (SO <sub>4</sub> <sup>2-</sup> )	Hydrogen sulphate(VI) (HSO <sub>4</sub> <sup>-</sup> )
Sulphuric(IV)acid	H <sub>2</sub> SO <sub>3</sub>	Dibasic	Sulphate(IV) (SO <sub>3</sub> <sup>2-</sup> )	Hydrogen sulphate(IV) (HSO <sub>3</sub> <sup>-</sup> )

Carbonic(IV)acid	H <sub>2</sub> CO <sub>3</sub>	Dibasic	Carbonate(IV)(CO <sub>3</sub> <sup>2-</sup> )	Hydrogen carbonate(IV) (HCO <sub>3</sub> <sup>-</sup> )
Phosphoric(V) acid	H <sub>3</sub> PO <sub>4</sub>	Tribasic	Phosphate(V)(PO <sub>4</sub> <sup>3-</sup> )	Dihydrogen phosphate(V) (H <sub>2</sub> PO <sub>4</sub> <sup>2-</sup> )  Hydrogen diphosphate(V) (HP <sub>2</sub> O <sub>4</sub> <sup>2-</sup> )

The table below show shows some examples of salts.

Base/alkali	Cation	Acid	Anion	Salt	Chemical name of salts
NaOH	Na <sup>+</sup>	HCl	Cl <sup>-</sup>	NaCl	Sodium(I)chloride
Mg(OH) <sub>2</sub>	Mg <sup>2+</sup>	H <sub>2</sub> SO <sub>4</sub>	SO <sub>4</sub> <sup>2-</sup>	MgSO <sub>4</sub> Mg(HSO <sub>4</sub> ) <sub>2</sub>	Magnesium sulphate(VI) Magnesium hydrogen sulphate(VI)
Pb(OH) <sub>2</sub>	Pb <sup>2+</sup>	HNO <sub>3</sub>	NO <sub>3</sub> <sup>-</sup>	Pb(NO <sub>3</sub> ) <sub>2</sub>	Lead(II)nitrate(V)
Ba(OH) <sub>2</sub>	Ba <sup>2+</sup>	HNO <sub>3</sub>	NO <sub>3</sub> <sup>-</sup>	Ba(NO <sub>3</sub> ) <sub>2</sub>	Barium(II)nitrate(V)
Ca(OH) <sub>2</sub>	Ba <sup>2+</sup>	H <sub>2</sub> SO <sub>4</sub>	SO <sub>4</sub> <sup>2-</sup>	MgSO <sub>4</sub>	Calcium sulphate(VI)
NH <sub>4</sub> OH	NH <sub>4</sub> <sup>+</sup>	H <sub>3</sub> PO <sub>4</sub>	PO <sub>4</sub> <sup>3-</sup>	(NH <sub>4</sub> ) <sub>3</sub> PO <sub>4</sub> (NH <sub>4</sub> ) <sub>2</sub> HPO <sub>4</sub> NH <sub>4</sub> H <sub>2</sub> PO <sub>4</sub>	Ammonium phosphate(V) Diammonium phosphate(V) Ammonium diphosphate(V)
KOH	K <sup>+</sup>	H <sub>3</sub> PO <sub>4</sub>	PO <sub>4</sub> <sup>3-</sup>	K <sub>3</sub> PO <sub>4</sub>	Potassium phosphate(V)
Al(OH) <sub>3</sub>	Al <sup>3+</sup>	H <sub>2</sub> SO <sub>4</sub>	SO <sub>4</sub> <sup>2-</sup>	Al <sub>2</sub> (SO <sub>4</sub> ) <sub>2</sub>	Aluminium(III)sulphate(VI)
Fe(OH) <sub>2</sub>	Fe <sup>2+</sup>	H <sub>2</sub> SO <sub>4</sub>	SO <sub>4</sub> <sup>2-</sup>	FeSO <sub>4</sub>	Iron(II)sulphate(VI)

$\text{Fe}(\text{OH})_3$	$\text{Fe}^{3+}$	$\text{H}_2\text{SO}_4$	$\text{SO}_4^{2-}$	$\text{Fe}_2(\text{SO}_4)_2$	Iron(III)sulphate(VI)
--------------------------	------------------	-------------------------	--------------------	------------------------------	-----------------------

(d) Some salts undergo **hygroscopy**, **deliquescence** and **efflorescence**.

(i) Hygroscopic salts /compounds are those that absorb water from the atmosphere but do not form a solution.

Some salts which are hygroscopic include anhydrous copper(II)sulphate(VI), anhydrous cobalt(II)chloride, potassium nitrate(V) common table salt.

(ii)Deliquescent salts /compounds are those that absorb water from the atmosphere and form a solution.

Some salts which are deliquescent include: Sodium nitrate(V),Calcium chloride, Sodium hydroxide, Iron(II)chloride, Magnesium chloride.

(iii)Efflorescent salts/compounds are those that lose their water of crystallization to the atmosphere.

Some salts which effloresces include: sodium carbonate decahydrate, Iron(II)sulphate(VI)heptahydrate, sodium sulphate (VI)decahydrate.

(e)Some salts contain water of crystallization.They are hydrated.Others do not contain water of crystallization. They are anhydrous.

Table showing some hydrated salts.

Name of hydrated salt	Chemical formula
Copper(II)sulphate(VI)pentahydrate	$\text{CuSO}_4 \cdot 5\text{H}_2\text{O}$
Aluminium(III)sulphate(VI)hexahydrate	$\text{Al}_2(\text{SO}_4)_3 \cdot 6\text{H}_2\text{O}$
Zinc(II)sulphate(VI)heptahydrate	$\text{ZnSO}_4 \cdot 7\text{H}_2\text{O}$
Iron(II)sulphate(VI)heptahydrate	$\text{FeSO}_4 \cdot 7\text{H}_2\text{O}$
Calcium(II)sulphate(VI)heptahydrate	$\text{CaSO}_4 \cdot 7\text{H}_2\text{O}$
Magnesium(II)sulphate(VI)heptahydrate	$\text{MgSO}_4 \cdot 7\text{H}_2\text{O}$
Sodium sulphate(VI)decahydrate	$\text{Na}_2\text{SO}_4 \cdot 10\text{H}_2\text{O}$
Sodium carbonate(IV)decahydrate	$\text{Na}_2\text{CO}_3 \cdot 10\text{H}_2\text{O}$
Potassium carbonate(IV)decahydrate	$\text{K}_2\text{CO}_3 \cdot 10\text{H}_2\text{O}$
Potassium sulphate(VI)decahydrate	$\text{K}_2\text{SO}_4 \cdot 10\text{H}_2\text{O}$

(f)Some salts exist as a simple salt while some as complex salts. Below are some complex salts.

Table of some complex salts

Name of complex salt	Chemical formula	Colour of the complex salt
Tetraamminecopper(II)sulphate(VI)	$\text{Cu}(\text{NH}_3)_4 \text{SO}_4 \cdot \text{H}_2\text{O}$	Royal/deep blue solution

Tetraamminezinc(II)nitrate(V)	$Zn(NH_3)_4(NO_3)_2$	Colourless solution
Tetraamminecopper(II) nitrate(V)	$Cu(NH_3)_4(NO_3)_2$	Royal/deep blue solution
Tetraamminezinc(II)sulphate(VI)	$Zn(NH_3)_4SO_4$	Colourless solution

(g)Some salts exist as two salts in one. They are called **double salts**.

Table of some double salts

Name of double salts	Chemical formula
Trona(sodium sesquicarbonate)	$Na_2CO_3 \cdot NaHCO_3 \cdot 2H_2O$
Ammonium iron(II)sulphate(VI)	$FeSO_4(NH_4)_2SO_4 \cdot 2H_2O$
Ammonium aluminium(III)sulphate(VI)	$Al_2(SO_4)_3(NH_4)_2SO_4 \cdot H_2O$

(h)Some salts dissolve in water to form a **solution**. They are said to be soluble. Others do not dissolve in water. They form a **suspension/precipitate** in water.

Table of solubility of salts

Soluble salts	Insoluble salts
All nitrate(V)salts	
All sulphate(VI)/ $SO_4^{2-}$ salts <b>except</b> →	Barium(II) sulphate(VI)/ $BaSO_4$ Calcium(II) sulphate(VI)/ $CaSO_4$ Lead(II) sulphate(VI)/ $PbSO_4$
All sulphate(IV)/ $SO_3^{2-}$ salts <b>except</b> →	Barium(II) sulphate(IV)/ $BaSO_3$ Calcium(II) sulphate(IV)/ $CaSO_3$ Lead(II) sulphate(IV)/ $PbSO_3$
All chlorides/ $Cl^-$ <b>except</b> →	Silver chloride/ $AgCl$ Lead(II)chloride/ $PbCl_2$ (dissolves in hot water)
All phosphate(V)/ $PO_4^{3-}$	
All sodium,potassium and ammonium salts	
All hydrogen carbonates/ $HCO_3^-$	
All hydrogen sulphate(VI)/ $HSO_4^-$	
Sodium carbonate/ $Na_2CO_3$ , potassium carbonate/ $K_2CO_3$ , ammonium carbonate $(NH_4)_2CO_3$ ←	<b>except</b> All carbonates
All alkalis( $KOH, NaOH, NH_4OH$ ) ←	<b>except</b> All bases

13 Salts can be prepared in a school laboratory by a method that uses its solubility in water.

(a) Soluble salts may be prepared by using any of the following methods:

**(i) Direct displacement/reaction of a metal with an acid.**

By reacting a metal higher in the reactivity series than hydrogen with a dilute acid, a salt is formed and hydrogen gas is evolved.

Excess of the metal must be used to ensure all the acid has reacted.

When effervescence/bubbling /fizzing has stopped, excess metal is filtered.

The filtrate is heated to concentrate then allowed to crystallize.

Washing with distilled water then drying between filter papers produces a sample crystal of the salt. i.e.

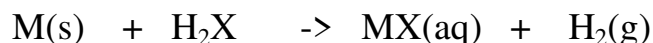

Examples

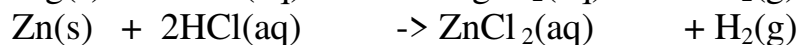
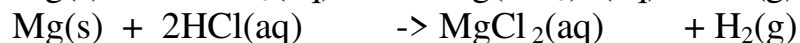
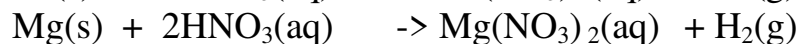
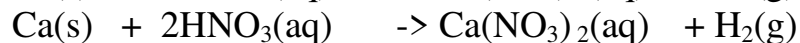
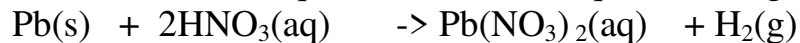
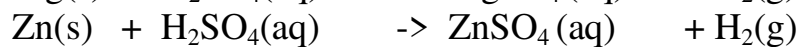
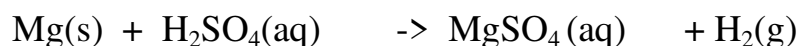

**(ii) Reaction of an insoluble base with an acid**

By adding an insoluble base (oxide/hydroxide) to a dilute acid until **no more dissolves**, in the acid, a salt and water are formed. Excess of the base is filtered off.

The filtrate is heated to concentrate, allowed to crystallize then washed with distilled water before drying between filter papers e.g.

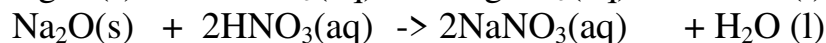
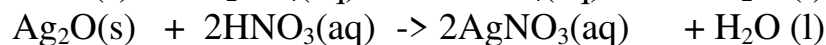
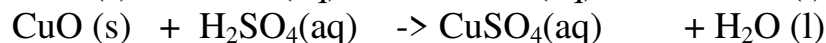
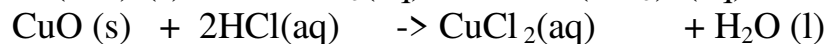
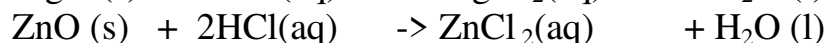
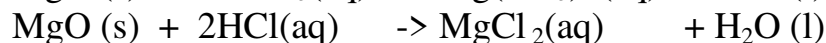
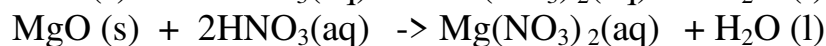
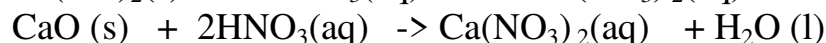
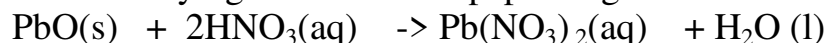

**(iii) reaction of insoluble /soluble carbonate /hydrogen carbonate with an acid.**

By adding an excess of a soluble /insoluble carbonate or hydrogen carbonate to a dilute acid, effervescence /fizzing/bubbling out of carbon(IV)oxide gas shows the

reaction is taking place. When effervescence /fizzing/bubbling out of the gas is over, excess of the insoluble carbonate is filtered off. The filtrate is heated to concentrate, allowed to crystallize then washed with distilled water before drying between filter paper papers e.g.

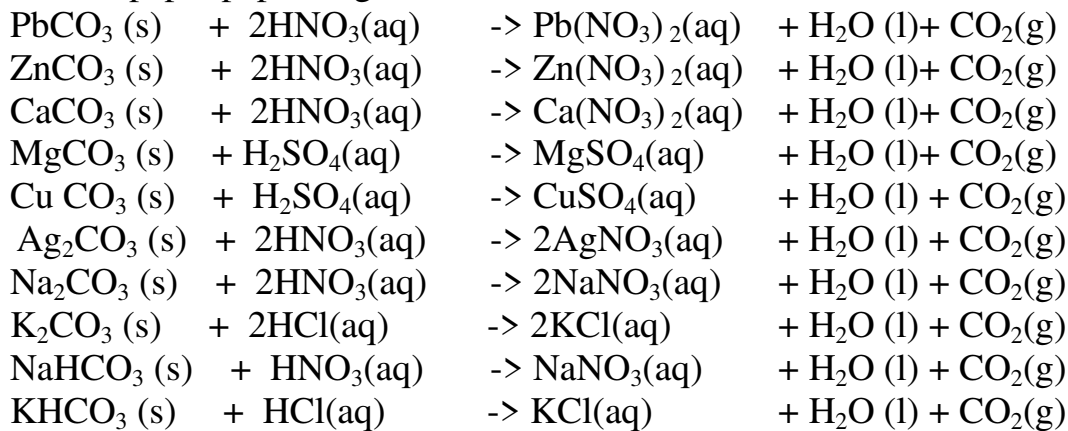

#### (iv)neutralization/reaction of soluble base/alkali with dilute acid

By adding an acid to a burette into a known volume of an alkali with 2-3 drops of an indicator, the colour of the indicator changes when the acid has completely reacted with an alkali at the **end point**. The procedure is then repeated without the indicator. The solution mixture is then heated to concentrate, allowed to crystallize, washed with distilled water before drying with filter papers. e.g.

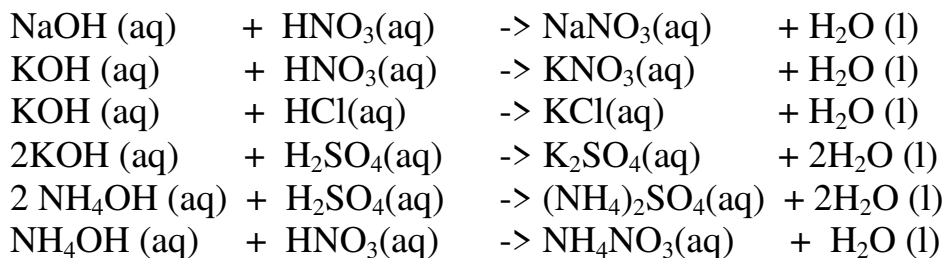

#### (iv)direct synthesis/combination.

When a metal **burn** in a gas jar containing a non metal, the two directly combine to form a salt. e.g.

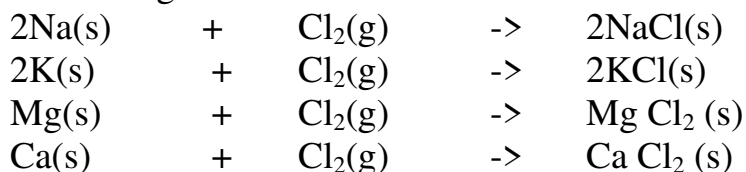

Some salts once formed undergo **sublimation** and **hydrolysis**. Care should be taken to avoid water/moisture into the reaction flask during their preparation. Such salts include aluminium(III)chloride( $\text{AlCl}_3$ ) and iron (III)chloride( $\text{FeCl}_3$ )

1. Heated aluminium foil reacts with chlorine to form aluminium(III)chloride that sublimes away from the source of heating then deposited as solid again

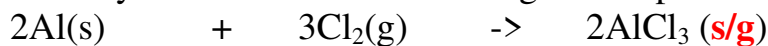

Once formed aluminium(III)chloride hydrolyses/reacts with water vapour / moisture present to form aluminium hydroxide solution and highly acidic fumes of hydrogen chloride gas.

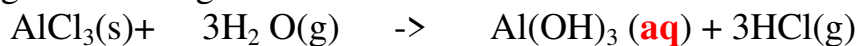

2. Heated iron filings reacts with chlorine to form iron(III)chloride that sublimes away from the source of heating then deposited as solid again

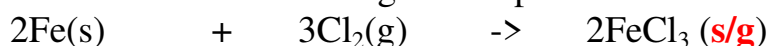

Once formed , aluminium(III)chloride hydrolyses/reacts with water vapour / moisture present to form aluminium hydroxide solution and highly acidic fumes of hydrogen chloride gas.

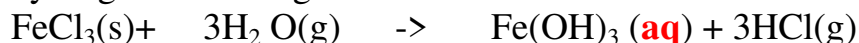

(b)**Insoluble** salts can be prepared by reacting **two** suitable **soluble** salts to form **one soluble** and **one insoluble**. This is called **double decomposition** or **precipitation**. The mixture is filtered and the **residue** is washed with distilled water then dried.

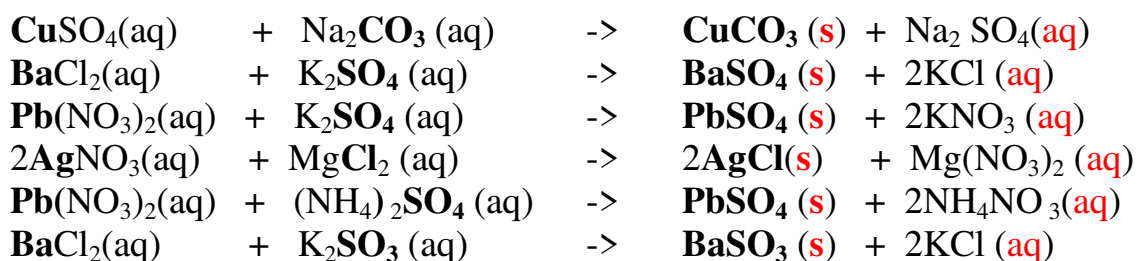

14. Salts may lose their water of crystallization , decompose ,melt or sublime on heating on a Bunsen burner flame.

The following shows the behavior of some salts on heating gently /or strongly in a laboratory school burner:

#### (a)effect of heat on chlorides

All chlorides have very high melting and boiling points and therefore are not affected by laboratory heating except ammonium chloride. Ammonium chloride **sublimes** on **gentle** heating. It **dissociate** into the constituent **ammonia** and **hydrogen chloride** gases on strong heating.



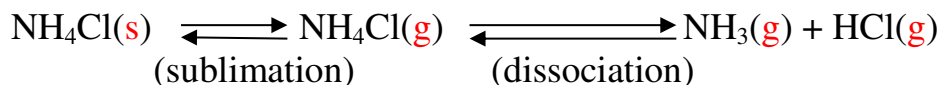

### (b) effect of heat on nitrate(V)

(i) Potassium nitrate(V)/KNO<sub>3</sub> and sodium nitrate(V)/NaNO<sub>3</sub> decompose on heating to form Potassium nitrate(III)/KNO<sub>2</sub> and sodium nitrate(III)/NaNO<sub>2</sub> and producing Oxygen gas in each case.

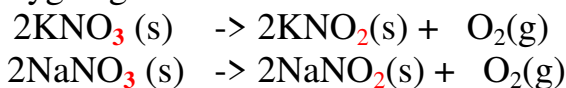

(ii) Heavy metal nitrates(V) salts decompose on heating to form the oxide and a mixture of brown acidic nitrogen(IV)oxide and oxygen gases. e.g.

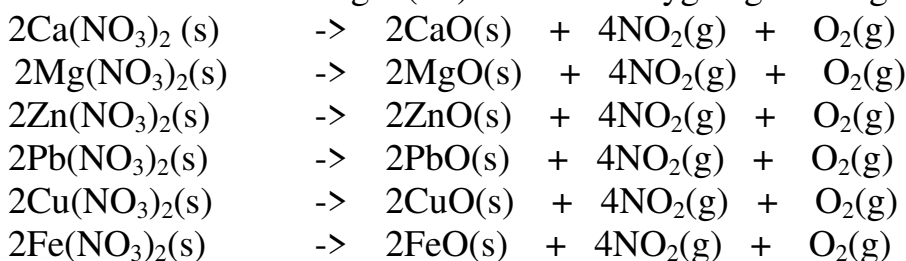

(iii) Silver(I)nitrate(V) and mercury(II) nitrate(V) are lowest in the reactivity series. They decompose on heating to form the **metal**(silver and mercury)and the Nitrogen(IV)oxide and oxygen gas. i.e.

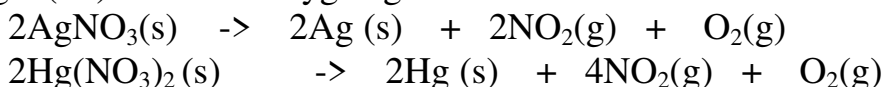

(iv) Ammonium nitrate(V) and Ammonium nitrate(III) decompose on heating to Nitrogen(I)oxide(relights/rekindles glowing splint) and nitrogen gas respectively. Water is also formed. i.e.

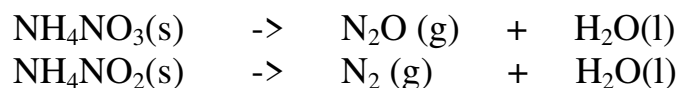

### (c) effect of heat on nitrate(V)

Only Iron(II)sulphate(VI), Iron(III)sulphate(VI) and copper(II)sulphate(VI) decompose on heating. They form the **oxide**, and produce highly acidic fumes of acidic **sulphur(IV)oxide** gas.

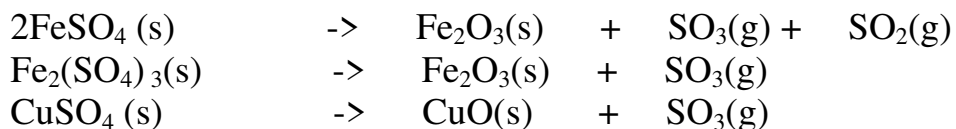

**(d) effect of heat on carbonates(IV) and hydrogen carbonate(IV).**

(i) Sodium carbonate(IV) and potassium carbonate(IV) **do not decompose** on heating.

(ii) Heavy metal nitrate(IV) salts decompose on heating to form the **oxide** and produce **carbon(IV)oxide** gas. Carbon (IV)oxide gas forms a white precipitate when bubbled in lime water. The white precipitate dissolves if the gas is in excess.

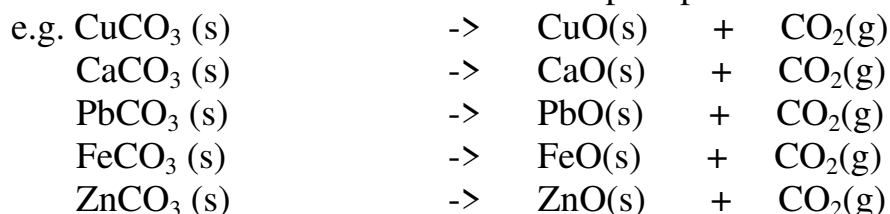

(iii) Sodium hydrogen carbonate(IV) and Potassium hydrogen carbonate(IV) decompose on heating to give the corresponding carbonate (IV) and form water and carbon(IV)oxide gas. i.e.



(iii) Calcium hydrogen carbonate (IV) and Magnesium hydrogen carbonate(IV) decompose on heating to give the corresponding carbonate (IV) and form water and carbon(IV)oxide gas. i. e.



# INTRODUCTION TO ELECTROLYSIS (ELECTROLYTIC CELL)

1. Electrolysis is defined simply as the **decomposition** of a **compound** by an electric current/**electricity**.

A compound that is decomposed by an electric current is called an electrolyte. Some electrolytes are **weak** while others are **strong**.

2. Strong electrolytes are those that are fully ionized/dissociated into (many) ions.

Common strong electrolytes include:

- (i) all **mineral** acids
- (ii) all strong **alkalis**/sodium hydroxide/potassium hydroxide.
- (iii) all soluble **salts**

3. Weak electrolytes are those that are partially/partly ionized/dissociated into (few) ions.

Common weak electrolytes include:

- (i) all **organic** acids
- (ii) all **bases** except sodium hydroxide/potassium hydroxide.
- (iii) **Water**

4. A compound that is **not** decomposed by an electric current is called non-electrolyte.

Non-electrolytes are those compounds /substances that exist as molecules and thus cannot ionize/dissociate into (any) ions .

Common non-electrolytes include:

- (i) most organic solvents (e.g. petrol/paraffin/benzene/methylbenzene/ethanol)
- (ii) all hydrocarbons (alkanes /alkenes/alkynes)
- (iii) Chemicals of life (e.g. proteins, carbohydrates, lipids, starch, sugar)

5. An electrolytes in **solid** state have **fused** /joined ions and therefore do **not** conduct electricity but the **ions** (cations and anions) are **free** and **mobile** in **molten** and **aqueous** (solution, dissolved in water) state.

6. During electrolysis, the free ions are attracted to the **electrodes**.

An electrode is a rod through which current enter and leave the electrolyte during electrolysis.

An electrode that does not influence/alter the products of electrolysis is called an **inert electrode**.

Common inert electrodes include:

(i) **Platinum**

(ii) **Carbon graphite**

Platinum is not usually used in a school laboratory because it is very **expensive**.

Carbon graphite is **easily**/readily and **cheaply** available (from used dry cells).

7. The **positive** electrode is called **Anode**. The anode is the electrode through which **current enter** the electrolyte/**electrons leave** the electrolyte

8. The **negative** electrode is called **Cathode**. The cathode is the electrode through which **current leave** the electrolyte / **electrons enter** the electrolyte

9. During the electrolysis, free **anions** are attracted to the **anode** where they **lose** /**donate** electrons to form **neutral** atoms/molecules. i.e.

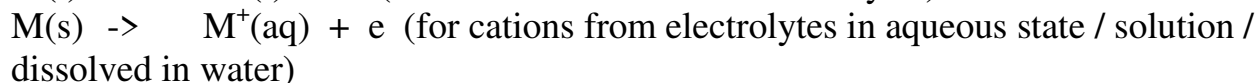

The neutral atoms /molecules form the **products** of electrolysis at the anode. This is called **discharge** at anode

10. During electrolysis, free **cations** are attracted to the **cathode** where they **gain** /**accept/acquire** electrons to form **neutral** atoms/molecules.

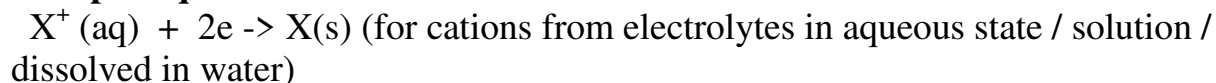

The neutral atoms /molecules form the **products** of electrolysis at the cathode. This is called **discharge** at cathode.

11. The below set up shows an electrolytic cell.

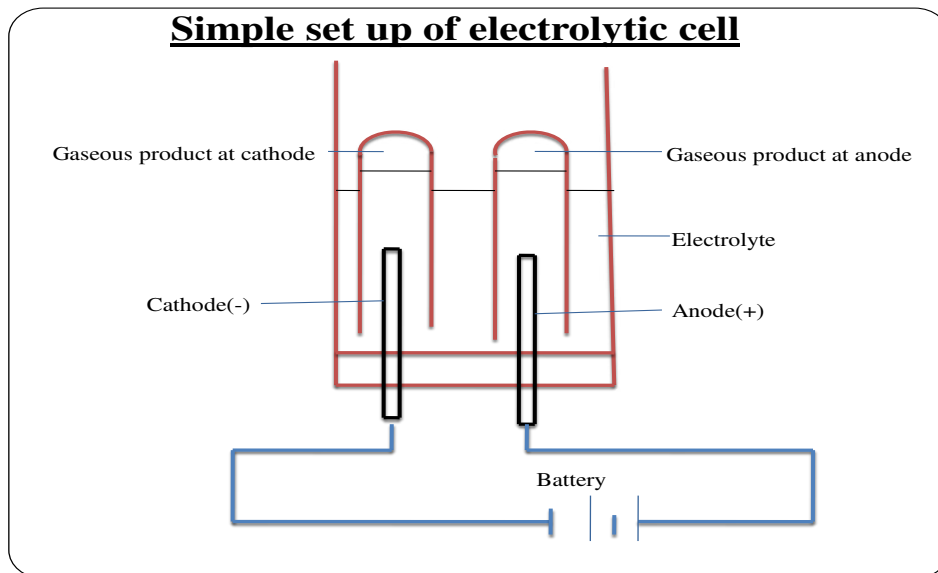

12. For a compound /salt containing only two ion/binary salt the products of electrolysis in an electrolytic cell can be determined as in the below examples:

**a) To determine the products of electrolysis of molten Lead(II)chloride**

(i) Decomposition of electrolyte into free ions;



(Compound decomposed into free cation and anion in **liquid** state)

(ii) At the cathode/negative electrode(-);

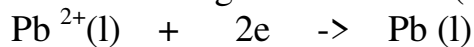

(Cation /  $\text{Pb}^{2+}$  gains / accepts / acquires electrons to form free **atom**)

(iii) At the anode/positive electrode(+);



(Anion /  $\text{Cl}^{-}$  donate/lose electrons to form free **atom** then a gas **molecule**)

(iv) Products of electrolysis therefore are;

I. At the cathode grey beads /solid lead metal.

II. At the anode pale green chlorine gas.

**b) To determine the products of electrolysis of molten Zinc bromide**

(i) Decomposition of electrolyte into free ions;



(Compound decomposed into free cation and anion in **liquid** state)

(ii) At the cathode/negative electrode(-);

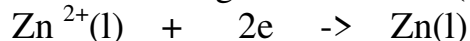

(Cation /  $\text{Zn}^{2+}$  gains / accepts / acquires electrons to form free **atom**)

(iii) At the anode/positive electrode(+);



(Anion /  $\text{Br}^-$  donate/lose electrons to form free **atom** then a liquid **molecule** which change to **gas** on heating)

(iv) Products of electrolysis therefore are;

I. At the cathode grey beads /solid Zinc metal.

II. At the anode **red** bromine **liquid** / **red/brown** bromine **gas**.

### c) To determine the products of electrolysis of molten sodium chloride

(i) Decomposition of electrolyte into free ions;

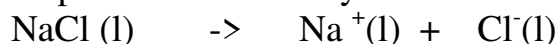

(Compound decomposed into free cation and anion in **liquid** state)

(ii) At the cathode/negative electrode(-);

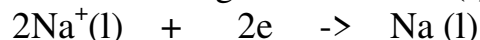

(Cation /  $\text{Na}^+$  gains / accepts / acquires electrons to form free **atom**)

(iii) At the anode/positive electrode(+);



(Anion /  $\text{Cl}^-$  donate/lose electrons to form free **atom** then a gas **molecule**)

(iv) Products of electrolysis therefore are;

I. At the cathode grey beads /solid sodium metal.

II. At the anode pale green chlorine gas.

### d) To determine the products of electrolysis of molten Aluminium (III)oxide

(i) Decomposition of electrolyte into free ions;

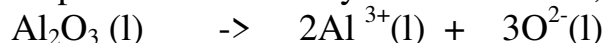

(Compound decomposed into free cation and anion in **liquid** state)

(ii) At the cathode/negative electrode(-);

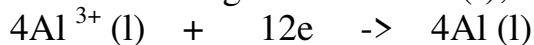

(Cation /  $\text{Al}^{3+}$  gains / accepts / acquires electrons to form free **atom**)

(iii) At the anode/positive electrode(+);



(Anion /  $6\text{O}^{2-}$  donate/lose 12 electrons to form free **atom** then three gas **molecule**)

(iv) Products of electrolysis therefore are;

I. At the cathode grey beads /solid aluminium metal.

II. At the anode colourless gas that relights/rekindles glowing splint.

**13.** In industries electrolysis has the following uses/applications:

**(a) Extraction of reactive metals from their ores.**

Potassium, sodium, magnesium, and aluminium are extracted from their ores using electrolytic methods.

**(b) Purifying copper after extraction from copper pyrites ores.**

Copper obtained from copper pyrites ores is not pure. After extraction, the copper is refined by electrolysis of copper(II)sulphate(VI) solution using the **impure** copper as **anode** and a thin strip of **pure** copper as **cathode**. Electrode ionization takes place there:

(i) At the cathode;  $\text{Cu}^{2+}(\text{aq}) + 2\text{e}^{-} \rightarrow \text{Cu}(\text{s})$  (Pure copper deposits on the strip)

(ii) At the anode;  $\text{Cu}(\text{s}) \rightarrow \text{Cu}^{2+}(\text{aq}) + 2\text{e}^{-}$  (impure copper erodes/dissolves)

**(c) Electroplating**

The label EPNS (Electro Plated Nickel Silver) on some steel/metallic utensils means they are plated/coated with silver and/or Nickel to **improve** their **appearance** (add their **aesthetic** value) and **prevent/slow corrosion** (**rusting** of iron). Electroplating is the process of coating a metal with another metal using an electric current.

During electroplating, the **cathode** is made of the metal to be **coated**/impure.

**Example:**

During the electroplating of a spoon with silver

(i) the spoon/impure is placed as the cathode (negative terminal of battery)

(ii) the pure silver is placed as the anode (positive terminal of battery)

(iii) the pure silver erodes/ionizes/dissociates to release electrons:

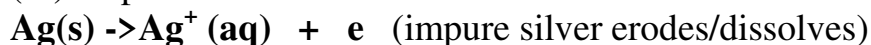

(iv) silver ( $\text{Ag}^+$ ) ions from electrolyte gain electrons to form pure silver deposits / coat / cover the spoon/impure  
 $\text{Ag}^+(\text{aq}) + \text{e}^- \rightarrow \text{Ag}(\text{s})$  (pure silver deposits /coat/cover on spoon)

$\text{Ag}(\text{s}) \rightarrow \text{Ag}^+(\text{aq}) + \text{e}^-$  (pure silver erodes/dissolves)

(iv) silver ( $\text{Ag}^+$ ) ions from electrolyte gain electrons to form pure silver deposits / coat /cover the spoon/impure

$\text{Ag}^+(\text{aq}) + \text{e}^- \rightarrow \text{Ag}(\text{s})$  (pure silver deposits /coat/cover on spoon)

Electrolytic set up during electroplating

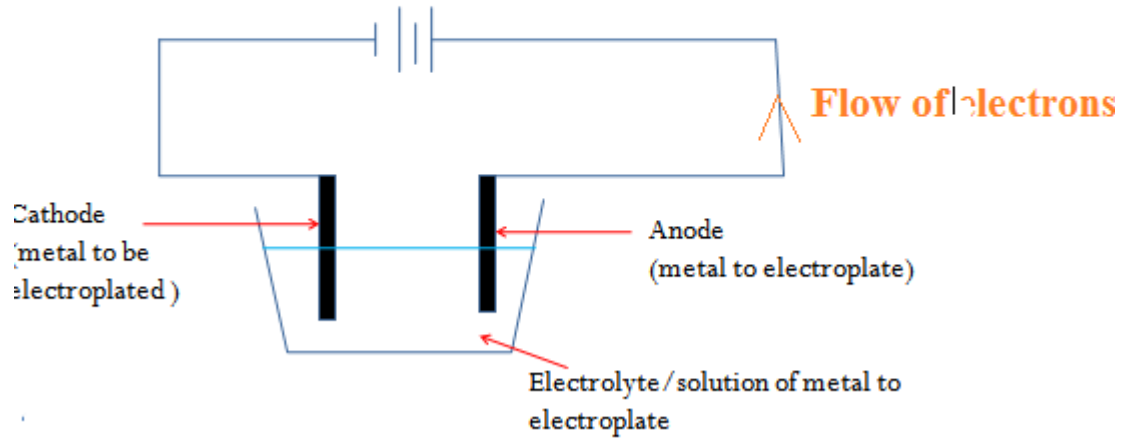



# CARBON AND ITS COMPOUNDS



Carbon is an element in Group IV(Group 4)of the Periodic table .It has atomic number 6 and electronic configuration  $2:4$  and thus has four valence electrons (tetravalent).It does not easily ionize but forms strong covalent bonds with other elements including itself.

## (a)Occurrence

Carbon mainly naturally occurs as:

- (i)allotropes of carbon i.e graphite, diamond and fullerenes.
- (ii)amorphous carbon in coal, peat ,charcoal and coke.
- (iii)carbon(IV)oxide gas accounting 0.03% by volume of normal air in the atmosphere.

## (b)Allotropes of Carbon

Carbon naturally occur in two main crystalline allotropic forms, carbon-graphite and carbon-diamond

Carbon-diamond	Carbon-graphite
Shiny crystalline solid	Black/dull crystalline solid
Has a very high melting/boiling point because it has a very closely packed giant tetrahedral structure joined by strong covalent bonds	Has a high melting/boiling point because it has a very closely packed giant hexagonal planar structure joined by strong covalent bonds
Has very high density(Hardest known	Soft

natural substance)	
Abrasive	Slippery
Poor electrical conductor because it has no free delocalized electrons	Good electrical conductor because it has free 4 <sup>th</sup> valency delocalized electrons
Is used in making Jewels, drilling and cutting metals	Used in making Lead-pencils, electrodes in batteries and as a lubricant
Has giant tetrahedral structure	Has giant hexagonal planar structure

### c) Properties of Carbon

#### (i) Physical properties of carbon

Carbon occur widely and naturally as a black solid

It is insoluble in water but soluble in carbon disulphide and organic solvents.

It is a poor electrical and thermal conductor.

#### (ii) Chemical properties of carbon

### **I. Burning**

#### Experiment

Introduce a small piece of charcoal on a Bunsen flame then lower it into a gas jar containing Oxygen gas. Put three drops of water. Swirl. Test the solution with blue and red litmus papers.

#### Observation

-Carbon chars then burns with a blue flame

-Colourless and odourless gas produced

-Solution formed turn blue litmus paper faint red. Red litmus paper remains red.

#### Explanation

Carbon burns in air and faster in Oxygen with a blue non-sooty/non-smoky flame forming Carbon (IV) oxide gas. Carbon burns in limited supply of air with a blue non-sooty/non-smoky flame forming Carbon (IV) oxide gas. Carbon (IV) oxide gas dissolve in water to form weak acidic solution of Carbonic (IV) acid.

#### Chemical Equation

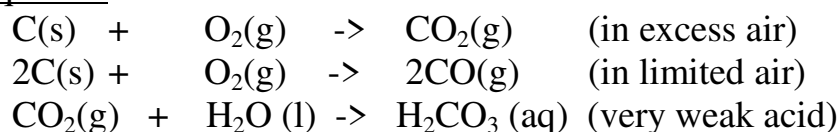

### **II. Reducing agent**

#### Experiment

Mix thoroughly equal amounts of powdered charcoal and copper (II) oxide into a crucible. Heat strongly.

#### Observation

Colour change from black to brown

#### Explanation

Carbon is a reducing agent. For ages it has been used to reducing metal oxide ores to metal, itself oxidized to carbon(IV)oxide gas. Carbon reduces black copper(II)oxide to brown copper metal

Chemical Equation

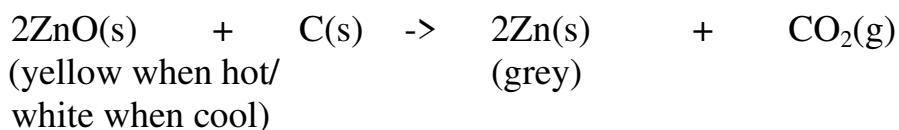
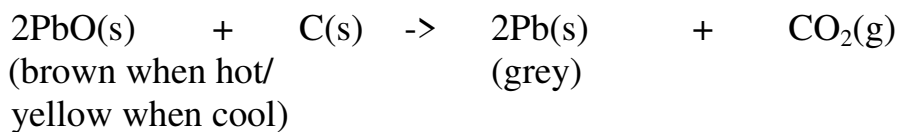
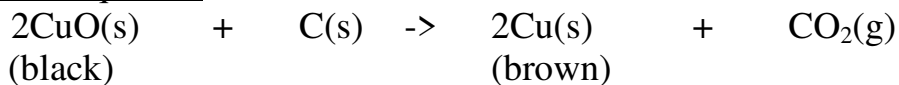

## **B: COMPOUNDS OF CARBON**

The following are the main compounds of Carbon

- (i) Carbon(IV)Oxide( $\text{CO}_2$ )
- (ii) Carbon(II)Oxide( $\text{CO}$ )
- (iii) Carbonate(IV) ( $\text{CO}_3^{2-}$ ) and hydrogen carbonate(IV)( $\text{HCO}_3^-$ )
- (iv) Sodium carbonate( $\text{Na}_2\text{CO}_3$ )

- (i) Carbon(IV)Oxide ( $\text{CO}_2$ )

### **(a) Occurrence**

Carbon(IV)oxide is found:

- in the air /atmosphere as 0.03% by volume.
- a solid carbon(IV)oxide mineral in Esageri near Eldame Ravine and Kerita near Limuru in Kenya.

### **(b) School Laboratory preparation**

In the school laboratory carbon(IV)oxide can be prepared in the school laboratory from the reaction of marble chips( $\text{CaCO}_3$ )or sodium hydrogen carbonate( $\text{NaHCO}_3$ ) with dilute hydrochloric acid.

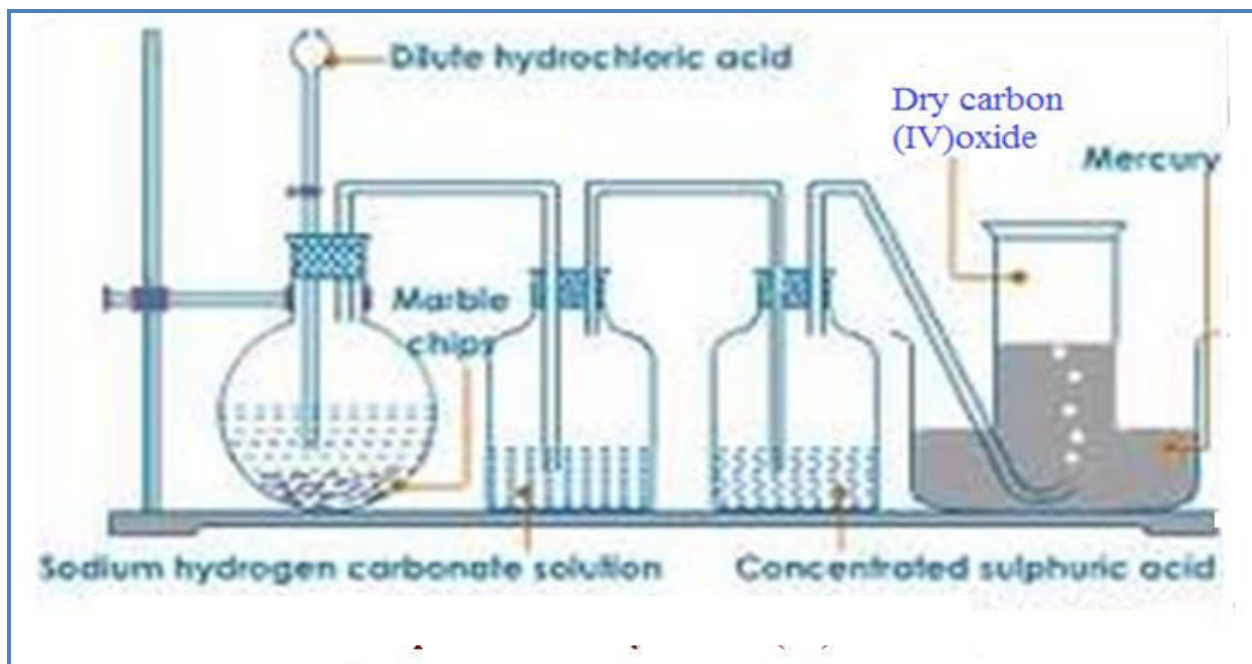

### (c) Properties of carbon(IV)oxide gas(Questions)

#### 1. Write the equation for the reaction for the school laboratory preparation of carbon (IV)oxide gas.

Any carbonate reacted with dilute hydrochloric acid should be able to generate carbon (IV)oxide gas.

#### Chemical equations

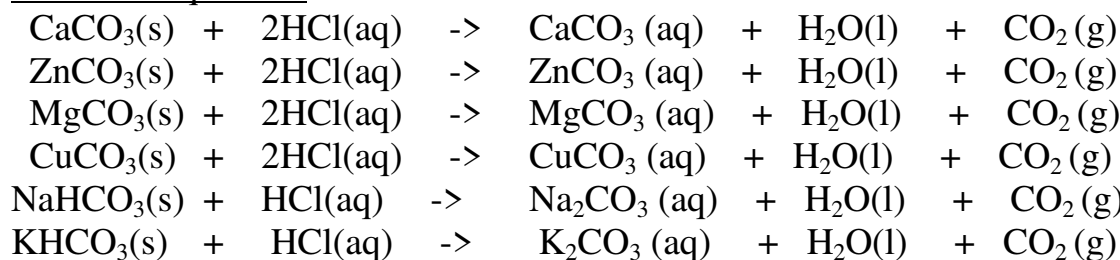

#### 2. What method of gas collection is used in preparation of Carbon(IV)oxide gas. Explain.

Downward delivery /upward displacement of air/over mercury  
Carbon(IV)oxide gas is about  $1\frac{1}{2}$  times denser than air.

#### 3. What is the purpose of :

##### (a) water?

To absorb the more volatile hydrogen chloride fumes produced during the vigorous reaction.

##### (b) sodium hydrogen carbonate?

To absorb the more volatile hydrogen chloride fumes produced during the vigorous reaction and by reacting with the acid to produce more carbon (IV)oxide gas .

### Chemical equation

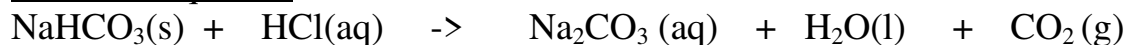

### **(c) concentrated sulphuric(VI) acid?**

To dry the gas/as a drying agent

### **4. Describe the smell of carbon(IV) oxide gas**

Colourless and odourless

### **5. Effect on lime water.**

#### Experiment

Bubbled carbon(IV) oxide gas into a test tube containing lime water for about three minutes

#### Observation

White precipitate is formed.

White precipitate dissolved when excess carbon(IV) oxide gas is bubbled .

#### Explanation

Carbon(IV) oxide gas reacts with lime water ( $\text{Ca}(\text{OH})_2$ ) to form an insoluble white precipitate of calcium carbonate. Calcium carbonate reacts with more Carbon(IV) oxide gas to form soluble Calcium hydrogen carbonate.

#### Chemical equation

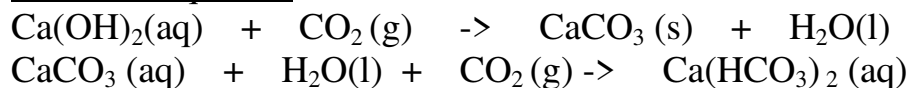

### **6. Effects on burning Magnesium ribbon**

#### Experiment

Lower a piece of burning magnesium ribbon into a gas jar containing carbon (IV) oxide gas.

#### Observation

The ribbon continues to burn with difficulty

White ash/solid is formed.

Black speck/solid/particles formed on the side of gas jar.

#### Explanation

Carbon(IV) oxide gas does not support combustion/burning. Magnesium burn to produce/release enough heat energy to decompose Carbon(IV) oxide gas to carbon and oxygen. Magnesium continues to burn in Oxygen forming white Magnesium Oxide solid/ash. Black speck/particle of carbon/charcoal residue forms on the sides of reaction flask. During the reaction Carbon(IV) oxide is reduced (Oxidizing agent) to carbon while Magnesium is Oxidized to Magnesium Oxide.

#### Chemical equation

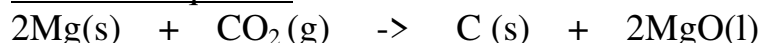

**7. Dry and wet litmus papers were separately put in a gas jar containing dry carbon (IV)oxide gas. State and explain the observations made.**

Observation

Blue dry litmus paper remain blue

Red dry litmus paper remain Red

Blue wet/damp/moist litmus paper turn red

Red wet/damp/moist litmus paper remain red

Explanation

Dry Carbon (IV) oxide gas is a molecular compound that does not dissociate/ionize to release  $H^+$  and thus has no effect on litmus papers.

Wet/damp/moist litmus papers contains water that dissolves/react with dry carbon (IV) oxide gas to form the weak solution of carbonic (IV) acid( $H_2CO_3$ ).

Carbonic (IV) acid dissociate/ionizes to a few /little free  $H^+$  and  $CO_3^{2-}$ .

The few  $H^+$  (aq) ions are responsible for turning blue litmus paper to faint red showing the gas is very weakly acidic.

Chemical equation



**8. Explain why Carbon (IV)oxide cannot be prepared from the reaction of:**

**(i) marble chips with dilute sulphuric(VI)acid.**

Explanation

Reaction forms insoluble calcium sulphate(VI)that cover/coat unreacted marble chips stopping further reaction

Chemical equation



**(ii) Lead(II)carbonate with dilute Hydrochloric acid.**

Reaction forms insoluble Lead(II)Chloride that cover/coat unreacted Lead(II) carbonate stopping further reaction unless the reaction mixture is heated.

Lead(II)Chloride is soluble in hot water.

Chemical equation



**9. Describe the test for the presence of Carbon (IV)oxide.**

Using burning splint

Lower a burning splint into a gas jar suspected to contain Carbon (IV)oxide gas.The burning splint is extinguished.

Using Lime water.

Bubble the gas suspected to be Carbon (IV)oxide gas.A white precipitate that dissolve in excess bubbling is formed.

### Chemical equation

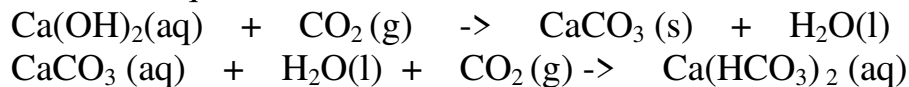

### **10.State three main uses of Carbon (IV)oxide gas**

- (i) In the Solvay process for the manufacture of soda ash/sodium carbonate
- (ii) In preservation of aerated drinks
- (iii) As fire extinguisher because it does not support combustion and is denser than air.
- (iv) In manufacture of Baking powder.

### **(ii) Carbon(II)Oxide (CO)**

#### **(a)Occurrence**

Carbon(II)oxide is found is found from incomplete combustion of fuels like petrol charcoal, liquefied Petroleum Gas/LPG.

#### **(b)School Laboratory preparation**

In the school laboratory carbon(II)oxide can be prepared from dehydration of methanoic acid/Formic acid(HCOOH) or Ethan-1,2-dioic acid/Oxalic acid(HOOC-COOH) using concentrated sulphuric(VI) acid. Heating is necessary.

**METHOD 1:**Preparation of Carbon (IV)Oxide from dehydration of Oxalic/ethan-1,2-dioic acid

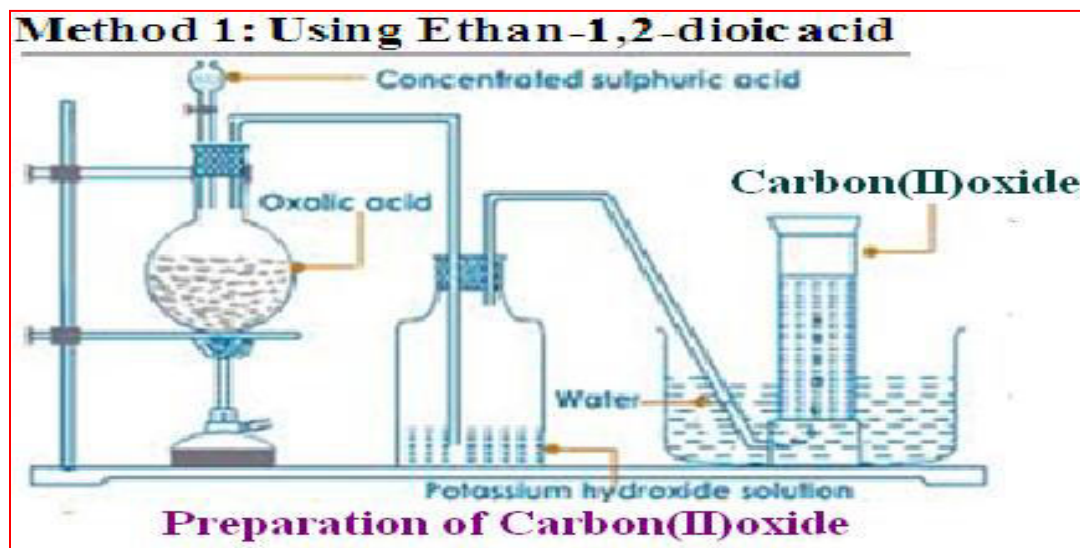

**METHOD 2:**Preparation of Carbon (IV)Oxide from dehydration of Formic/Methanoic acid



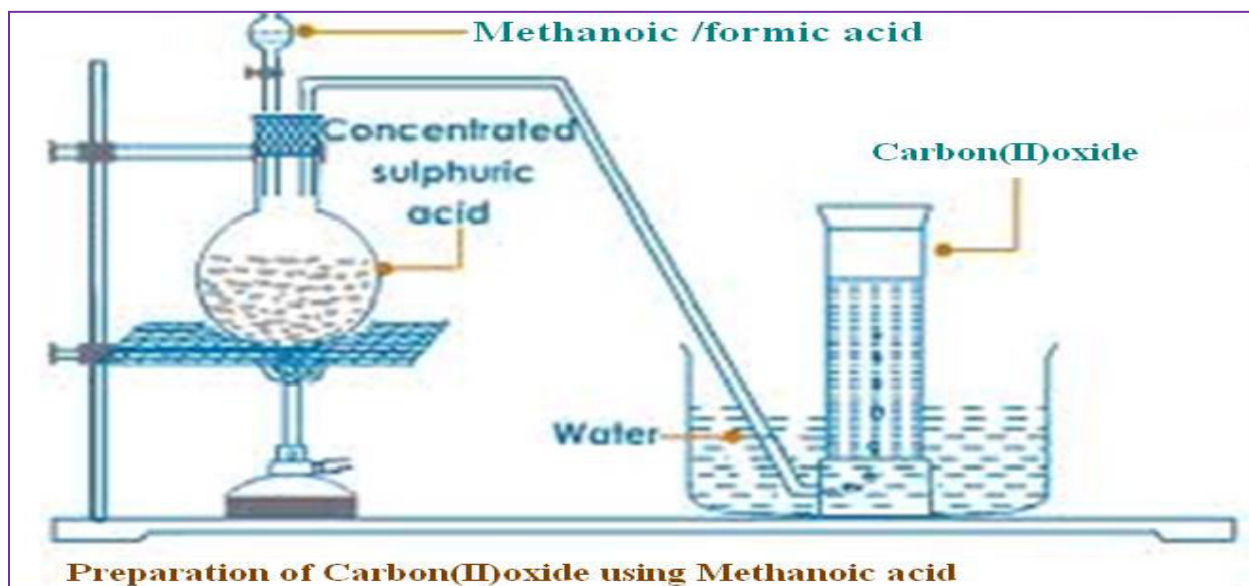

### (c) Properties of Carbon (II)Oxide(Questions)

**1. Write the equation for the reaction for the preparation of carbon(II)oxide using;**

(i) Method 1;

Chemical equation

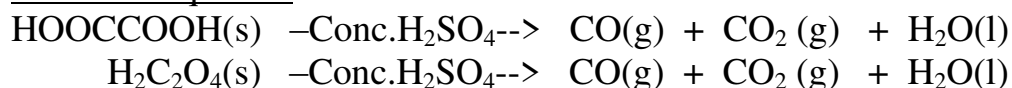

(ii) Method 2;

Chemical equation

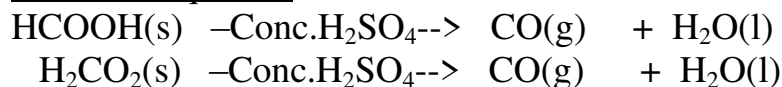

**2. What method of gas collection is used during the preparation of carbon (II) oxide.**

Over water because the gas is insoluble in water.

Downward delivery because the gas is 1 ½ times denser than air .

**3. What is the purpose of :**

**(i) Potassium hydroxide/sodium hydroxide in Method 1**

To absorb/ remove carbon (II) oxide produced during the reaction.

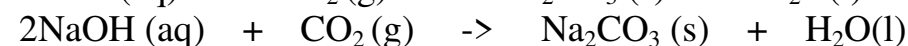
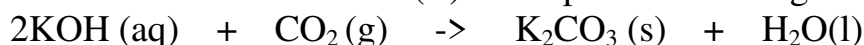

**(ii) Concentrated sulphuric(VI)acid in Method 1 and 2.**

Dehydrating agent –removes the element of water (Hydrogen and Oxygen in ratio 2:1) present in both methanoic and ethan-1,2-dioic acid.

**4. Describe the smell of carbon(II)oxide.**

Colourless and odourless.

**5. State and explain the observation made when carbon(IV)oxide is bubbled in lime water for a long time.**

No white precipitate is formed.

**6. Dry and wet/moist/damp litmus papers were separately put in a gas jar containing dry carbon(IV)oxide gas. State and explain the observations made.**

Observation

- blue dry litmus paper remains blue
- red dry litmus paper remains red
- wet/moist/damp blue litmus paper remains blue
- wet/moist/damp red litmus paper remains red

Explanation

Carbon(II)oxide gas is a molecular compound that does not dissociate /ionize to release H<sup>+</sup> ions and thus has no effect on litmus papers. Carbon(II)oxide gas is therefore a **neutral** gas.

**7. Carbon (II)oxide gas was ignited at the end of a generator as below.**

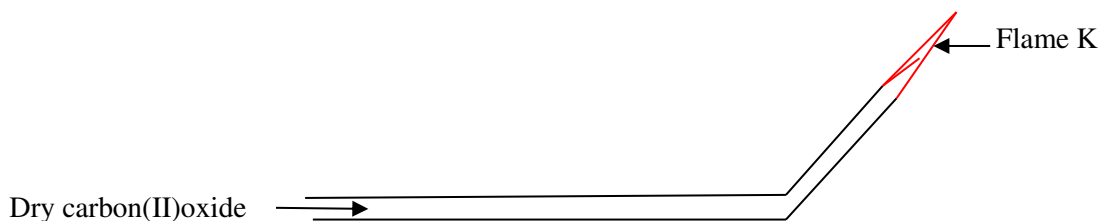

**(i)State the observations made in flame K.**

Gas burns with a blue flame

**(ii)Write the equation for the reaction taking place at flame K.**

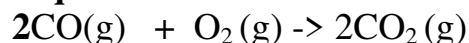

**8. Carbon(II)oxide is a reducing agent. Explain**

Experiment

Pass carbon(II)oxide through glass tube containing copper (II)oxide. Ignite any excess poisonous carbon(II)oxide.

Observation

Colour change from black to brown. Excess carbon (II)oxide burn with a blue flame.

### Explanation

Carbon is a reducing agent. It is used to reduce metal oxide ores to metal, itself oxidized to carbon(IV)oxide gas. Carbon(II)Oxide reduces black copper(II)oxide to brown copper metal

### Chemical Equation

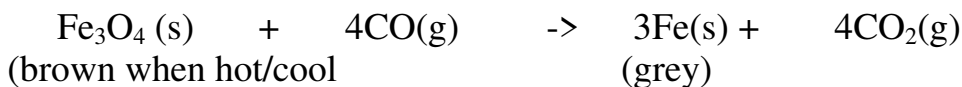
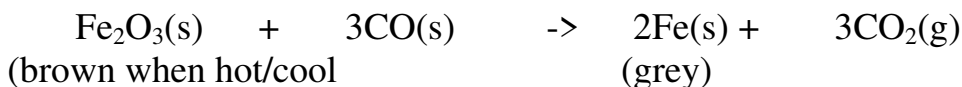
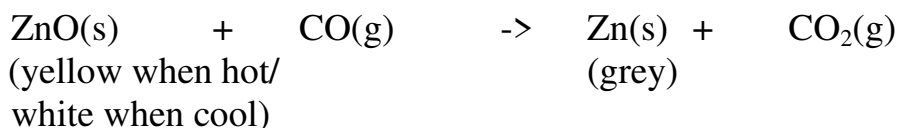
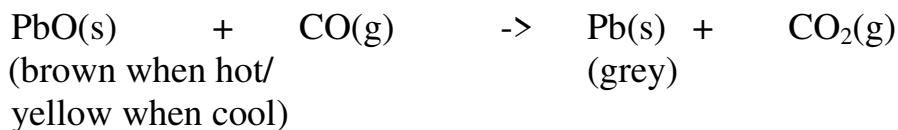

These reaction are used during the extraction of many metals from their ore.

### **9. Carbon (II) oxide is a pollutant. Explain.**

Carbon(II)oxide is highly poisonous/toxic.It preferentially combine with haemoglobin to form stable carboxyhaemoglobin in the blood instead of oxyhaemoglobin.This reduces the free haemoglobin in the blood causing nausea , coma then death.

### **10.The diagram below show a burning charcoal stove/burner/jiko. Use it to answer the questions that follow.**

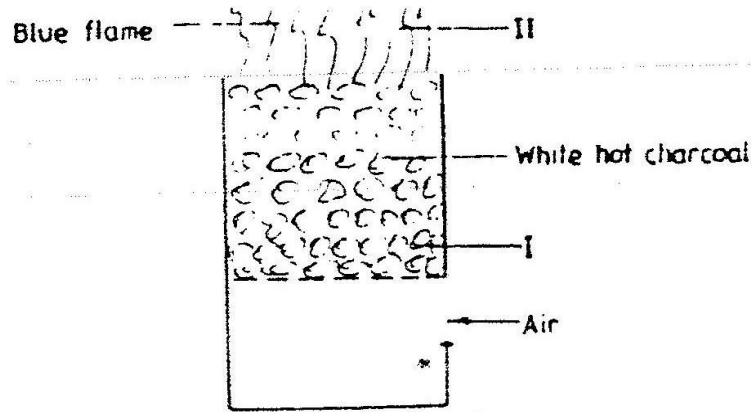

## **Explain the changes that take place in the burner**

### Explanation

Charcoal stove has air holes through which air enters. Air oxidizes carbon to carbon(IV)oxide gas at region I. This reaction is exothermic(-ΔH) producing more heat.

### Chemical equation



Carbon(IV)oxide gas formed rises up to meet more charcoal which reduces it to Carbon(II)oxide gas.

### Chemical equation

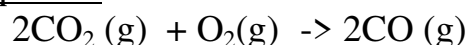

At the top of burner in region II, Carbon (II)oxide gas is further oxidized to Carbon(IV)oxide gas if there is plenty of air but escape if the air is limited poisoning the living things around.

### Chemical equation

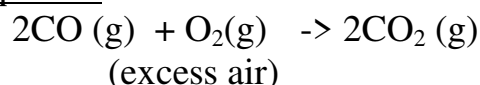

## **11. Describe the test for the presence of carbon(II)oxide gas.**

### Experiment

Burn/Ignite the pure sample of the gas. Pass/Bubble the products into lime water/Calcium hydroxide .

### Observation

Colourless gas burns with a blue flame. A white precipitate is formed that dissolve on further bubbling of the products.

### Chemical equation

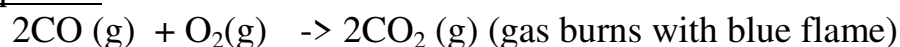

### Chemical equation

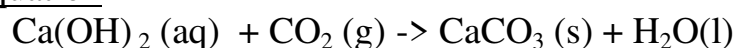

### Chemical equation

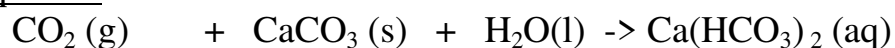

## **12. State the main uses of carbon (II)oxide gas.**

- (i) As a fuel /water gas
- (ii)As a reducing agent in the blast furnace for extracting iron from iron ore(Magnetite/Haematite)
- (iii)As a reducing agent in extraction of Zinc from Zinc ore/Zinc blende
- (iv) As a reducing agent in extraction of Lead from Lead ore/Galena
- (v) As a reducing agent in extraction of Copper from Copper iron sulphide/Copper pyrites.

### (iii) Carbonate(IV) ( $\text{CO}_3^{2-}$ ) and hydrogen carbonate(IV) ( $\text{HCO}_3^-$ )

1. Carbonate (IV) ( $\text{CO}_3^{2-}$ ) are normal salts derived from carbonic(IV) acid ( $\text{H}_2\text{CO}_3$ ) and hydrogen carbonate (IV) ( $\text{HCO}_3^-$ ) are acid salts derived from carbonic(IV) acid. Carbonic(IV) acid ( $\text{H}_2\text{CO}_3$ ) is formed when carbon(IV) oxide gas is bubbled in water. It is a dibasic acid with two ionizable hydrogens.

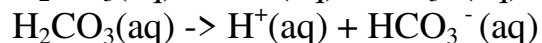
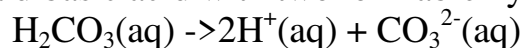

2. Carbonate (IV) ( $\text{CO}_3^{2-}$ ) are insoluble in water **except**  $\text{Na}_2\text{CO}_3$ ,  $\text{K}_2\text{CO}_3$  and  $(\text{NH}_4)_2\text{CO}_3$

3. Hydrogen carbonate (IV) ( $\text{HCO}_3^-$ ) are soluble in water. Only five hydrogen carbonates exist.  **$\text{NaHCO}_3$ ,  $\text{KHCO}_3$ ,  $\text{NH}_4\text{HCO}_3$ ,  $\text{Ca}(\text{HCO}_3)_2$  and  $\text{Mg}(\text{HCO}_3)_2$**   $\text{Ca}(\text{HCO}_3)_2$  and  $\text{Mg}(\text{HCO}_3)_2$  exist only in aqueous solutions.

3. The following experiments show the effect of heat on Carbonate (IV) ( $\text{CO}_3^{2-}$ ) and Hydrogen carbonate (IV) ( $\text{HCO}_3^-$ ) salts:

#### Experiment

In a clean dry test tube place separately about 1.0 of the following:

Zinc(II) carbonate(IV), sodium hydrogen carbonate(IV), sodium carbonate(IV), Potassium carbonate(IV) ammonium carbonate(IV), potassium hydrogen carbonate(IV), Lead(II) carbonate(IV), Iron(II) carbonate(IV), and copper(II) carbonate(IV). Heat each portion gently the strongly. Test any gases produced with lime water.

#### Observation

(i) Colorless droplets form on the cooler parts of test tube in case of sodium carbonate(IV) and Potassium carbonate(IV).

(ii) White residue/solid left in case of sodium hydrogen carbonate(IV), sodium carbonate(IV), Potassium carbonate(IV) and potassium hydrogen carbonate(IV).

(iii) Colour changes from blue/green to black in case of copper(II) carbonate(IV).

(iv) Colour changes from green to brown/yellow in case of Iron (II) carbonate(IV).

(v) Colour changes from white when cool to yellow when hot in case of Zinc (II) carbonate(IV).

(vi) Colour changes from yellow when cool to brown when hot in case of Lead (II) carbonate(IV).

(vii) Colourless gas produced that forms a white precipitate with lime water in all cases.

#### Explanation

1. Sodium carbonate(IV) and Potassium carbonate(IV) exist as hydrated salts with 10 molecules of water of crystallization that condenses and collects on cooler parts of test tube as a colourless liquid.

#### Chemical equation





2. Carbonate (IV) ( $\text{CO}_3^{2-}$ ) and Hydrogen carbonate (IV) ( $\text{HCO}_3^-$ ) salts decompose on heating except Sodium carbonate(IV) and Potassium carbonate(IV).

(a) Sodium hydrogen carbonate(IV) and Potassium hydrogen carbonate(IV) decompose on heating to form sodium carbonate(IV) and Potassium carbonate(IV). Water and carbon(IV)oxide gas are also produced.

Chemical equation

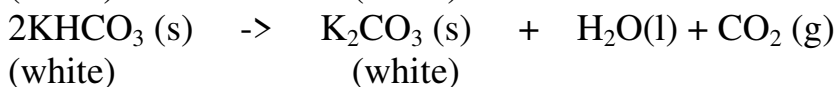
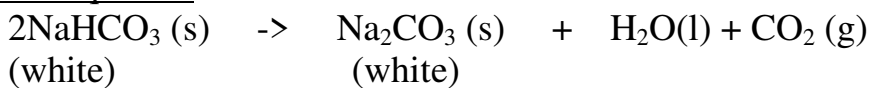

(b) Calcium hydrogen carbonate(IV) and Magnesium hydrogen carbonate(IV) decompose on heating to form insoluble Calcium carbonate(IV) and Magnesium carbonate(IV). Water and carbon(IV)oxide gas are also produced.

Chemical equation

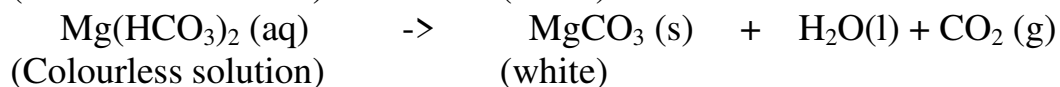
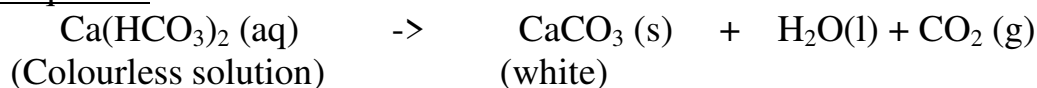

(c) Ammonium hydrogen carbonate(IV) decompose on heating to form ammonium carbonate(IV) .Water and carbon(IV)oxide gas are also produced.

Chemical equation

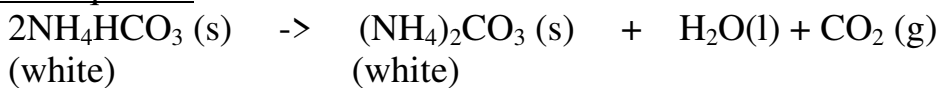

(d)All other carbonates decompose on heating to form the metal oxide and produce carbon(IV)oxide gas e.g.

Chemical equation

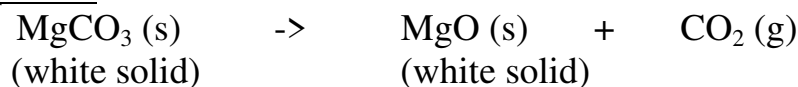

Chemical equation

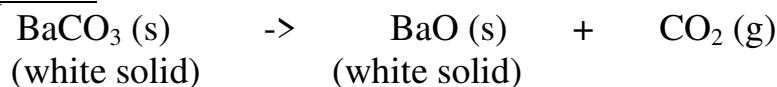

Chemical equation

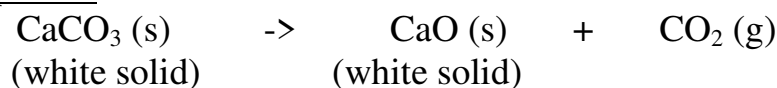

Chemical equation



Chemical equation

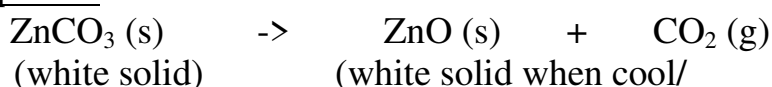

Yellow solid when hot)

Chemical equation

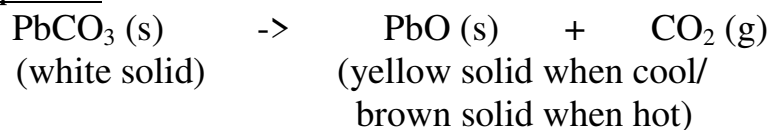

4. The following experiments show the presence of Carbonate (IV) ( $\text{CO}_3^{2-}$ ) and Hydrogen carbonate (IV) ( $\text{HCO}_3^-$ ) ions in sample of a salt:

(a) Using Lead(II) nitrate(V)

I. Using a portion of salt solution in a test tube .add four drops of Lead(II)nitrate(V)solution.Preserve.

Observation	inference
White precipitate/ppt	$\text{CO}_3^{2-}$ , $\text{SO}_3^{2-}$ , $\text{SO}_4^{2-}$ , $\text{Cl}^-$

II. To the preserved solution ,add six drops of dilutte nitric(V)acid. Preserve.

Observation	inference
White precipitate/ppt persists	$\text{SO}_4^{2-}$ , $\text{Cl}^-$
White precipitate/ppt dissolves	$\text{CO}_3^{2-}$ , $\text{SO}_3^{2-}$

II. To the preserved sample( that forms a precipitate ),heat to boil.

Observation	inference
White precipitate/ppt persists	$\text{SO}_4^{2-}$
White precipitate/ppt dissolves	$\text{Cl}^-$

II. To the preserved sample( that do not form a precipitate ),add three drops of acidified potassium manganate(VII)/lime water

Observation	inference
Effervescence/bubbles/fizzing colourless gas produced Acidified $\text{KMnO}_4$ decolorized/no white precipitate on lime water	$\text{SO}_3^{2-}$
Effervescence/bubbles/fizzing colourless gas produced Acidified $\text{KMnO}_4$ not decolorized/ white precipitate on lime water	$\text{CO}_3^{2-}$

Experiments/Observations:

**(b)Using Barium(II)nitrate(V)/ Barium(II)chloride**

I. To about 5cm<sup>3</sup> of a salt solution in a test tube add four drops of Barium(II) nitrate (V) / Barium(II)chloride. Preserve.

Observation	Inference
White precipitate/ppt	SO <sub>4</sub> <sup>2-</sup> , SO <sub>3</sub> <sup>2-</sup> , CO <sub>3</sub> <sup>2-</sup> ions

II. To the preserved sample in (I) above, add six drops of 2M nitric(V) acid . Preserve.

Observation 1

Observation	Inference
White precipitate/ppt persists	SO <sub>4</sub> <sup>2-</sup> , ions

Observation 2

Observation	Inference
White precipitate/ppt dissolves	SO <sub>3</sub> <sup>2-</sup> , CO <sub>3</sub> <sup>2-</sup> , ions

III.To the preserved sample observation 2 in (II) above, add 4 drops of acidified potassium manganate(VII) /dichromate(VI).

Observation 1

Observation	Inference
(i)acidified potassium manganate(VII)decolorized (ii)Orange colour of acidified potassium dichromate(VI) turns to green	SO <sub>3</sub> <sup>2-</sup> ions

Observation 2

Observation	Inference
(i)acidified potassium manganate(VII) not decolorized (ii)Orange colour of acidified potassium dichromate(VI) does not turns to green	CO <sub>3</sub> <sup>2-</sup> ions

Explanations

**Using Lead(II)nitrate(V)**



(i)Lead(II)nitrates(V) solution reacts with chlorides( $\text{Cl}^-$ ), Sulphate (VI) salts ( $\text{SO}_4^{2-}$ ), Sulphate (IV)salts ( $\text{SO}_3^{2-}$ ) and carbonates( $\text{CO}_3^{2-}$ ) to form the insoluble white precipitate of Lead(II)chloride, Lead(II)sulphate(VI), Lead(II) sulphate (IV) and Lead(II)carbonate(IV).

Chemical/ionic equation:

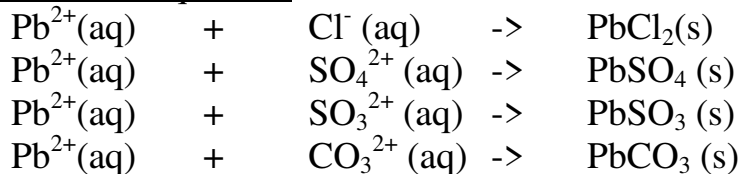

(ii)When the insoluble precipitates are acidified with nitric(V) acid,

- Lead(II)chloride and Lead(II)sulphate(VI) do not react with the acid and thus their white precipitates remain/ persists.

- Lead(II) sulphate (IV) and Lead(II)carbonate(IV) reacts with the acid to form **soluble** Lead(II) nitrate (V) and produce/effervesces/fizzes/bubbles out **sulphur(IV)oxide** and **carbon(IV)oxide** gases respectively.

.Chemical/ionic equation:

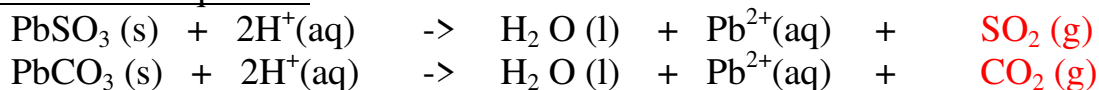

(iii)When Lead(II)chloride and Lead(II)sulphate(VI) are heated/warmed;

- Lead(II)chloride dissolves in hot water/on boiling(recrystallizes on cooling)

- Lead(II)sulphate(VI) do not dissolve in hot water thus its white precipitate persists/remains on heating/boiling.

(iv)When sulphur(IV)oxide and carbon(IV)oxide gases are produced;

- **sulphur(IV)oxide** will decolorize acidified potassium manganate(VII) and / or Orange colour of acidified potassium dichromate(VI) will turn to green.

**Carbon(IV)oxide will not.**

Chemical equation:

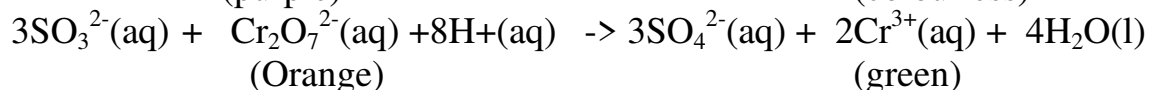
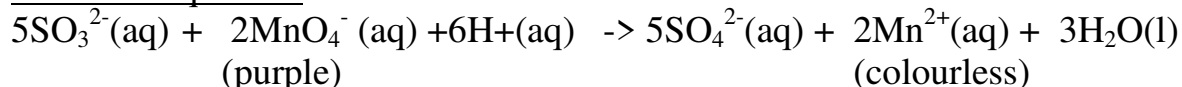

- **Carbon(IV)oxide** forms an insoluble white precipitate of calcium carbonate if three drops of lime water are added into the reaction test tube when effervescence is taking place. **Sulphur(IV)oxide will not.**

Chemical equation:

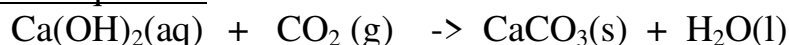

These tests should be done immediately after acidifying to ensure the gases produced react with the oxidizing agents/lime water.

### Using Barium(II)nitrate(V)/ Barium(II)Chloride

(i) Barium(II)nitrate(V) and/ or Barium(II)chloride solution reacts with Sulphate (VI) salts ( $\text{SO}_4^{2-}$ ), Sulphate (IV)salts ( $\text{SO}_3^{2-}$ ) and carbonates( $\text{CO}_3^{2-}$ ) to form the insoluble white precipitate of Barium(II)sulphate(VI), Barium(II) sulphate (IV) and Barium(II)carbonate(IV).

Chemical/ionic equation:

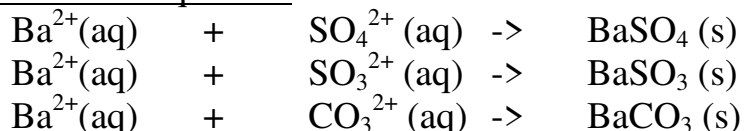

(ii) When the insoluble precipitates are acidified with nitric(V) acid,

- Barium (II)sulphate(VI) do not react with the acid and thus its white precipitates remain/ persists.

- Barium(II) sulphate (IV) and Barium(II)carbonate(IV) reacts with the acid to form **soluble** Barium(II) nitrate (V) and produce /effervesces /fizzes/ bubbles out **sulphur(IV)oxide** and **carbon(IV)oxide** gases respectively.

.Chemical/ionic equation:

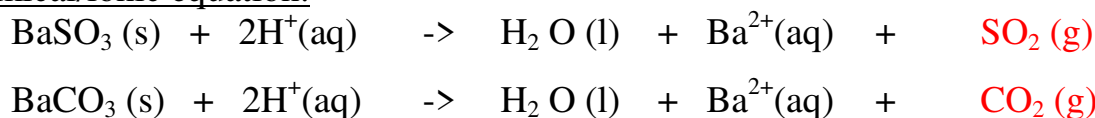

(iii) When sulphur(IV)oxide and carbon(IV)oxide gases are produced;

- **sulphur(IV)oxide** will decolorize acidified potassium manganate(VII) and / or Orange colour of acidified potassium dichromate(VI) will turns to green.

**Carbon(IV)oxide will not.**

Chemical equation:

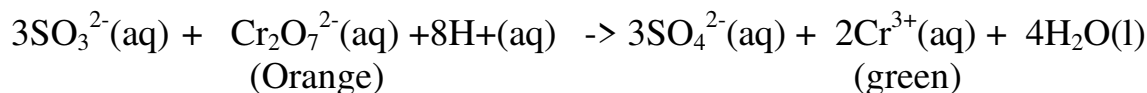
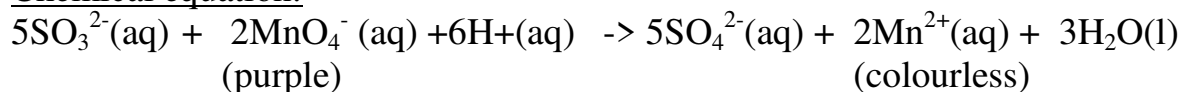

- **Carbon(IV)oxide** forms an insoluble white precipitate of calcium carbonate if three drops of lime water are added into the reaction test tube when effervescence is taking place. **Sulphur(IV)oxide will not.**

Chemical equation:

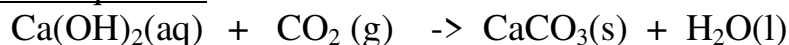

These tests should be done immediately after acidifying to ensure the gases produced react with the oxidizing agents/lime water.

### (iii) Sodium carbonate(IV) ( $\text{Na}_2\text{CO}_3$ )

#### (a)Extraction of sodium carbonate from soda ash

Sodium carbonate naturally occurs in Lake Magadi in Kenya as Trona. trona is the double salt ; sodium sesquicarbonate.  $\text{NaHCO}_3 \cdot \text{Na}_2\text{CO}_3 \cdot \text{H}_2\text{O}$ . It is formed from the volcanic activity that takes place in Lake Naivasha, Nakuru ,Bogoria and Elementeita .All these lakes drain into Lake Magadi through underground rivers. Lake Magadi has no outlet.

Solubility of Trona decrease with increase in temperature.High temperature during the day causes trona to naturally crystallize .It is mechanically scooped/dredged/dug and put in a furnace.

Inside the furnace, trona decompose into soda ash/sodium carbonate.

#### Chemical equation

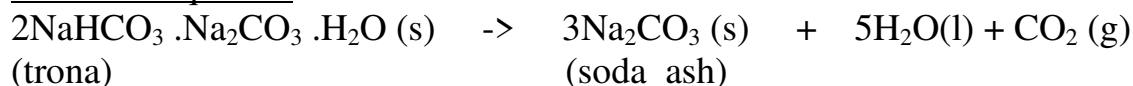

Soda ash is then bagged and sold as Magadi soda.It is mainly used:

- (i)in making glass to lower the melting point of raw materials (sand/ $\text{SiO}_2$  from  $1650^\circ\text{C}$  and  $\text{CaO}$  from  $2500^\circ\text{C}$  to around  $1500^\circ\text{C}$ )
- (ii)in softening hard water
- (iii)in the manufacture of soapless detergents.
- (iv)Swimming pool “pH increaser”

Sodium chloride is also found dissolved in the lake. Solubility of sodium chloride decrease with decreases in temperature/ sodium chloride has lower solubility at lower temperatures. When temperatures decrease at night it crystallize out .The crystals are then mechanically dug/dredged /scooped then packed for sale as animal/cattle feeds and seasoning food.

### Summary flow diagram showing the extraction of Soda ash from Trona

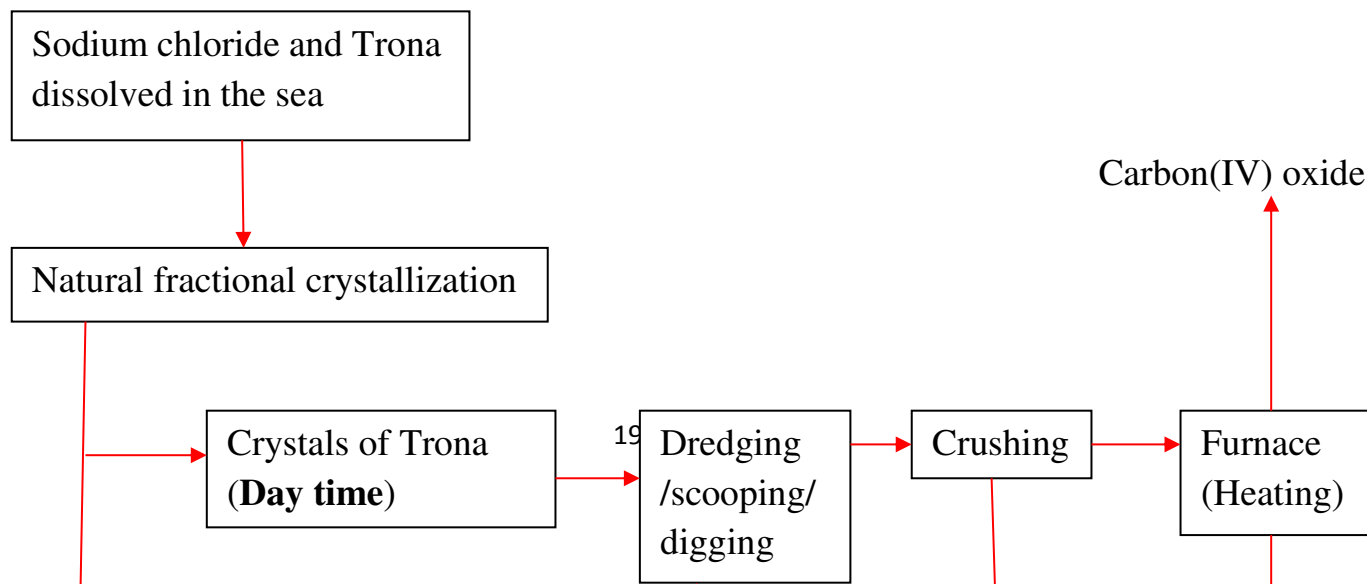

## **b)The Solvay process for industrial manufacture of sodium carbonate(IV)**

### **(i)Raw materials.**

- Brine** /Concentrated Sodium chloride from salty seas/lakes.
- Ammonia** gas from Haber.
- Limestone** /Calcium carbonate from chalk /limestone rich rocks.
- Water** from rivers/lakes.

### **(ii)Chemical processes**

Ammonia gas is passed **up** to meet a **downward** flow of sodium chloride solution / brine to form **ammoniated** brine/**ammoniacal** brine **mixture** in the **ammoniated brine chamber**

The ammoniated brine mixture is then pumped up, atop the carbonator/ solvay tower.

In the carbonator/ solvay tower, ammoniated brine/ammoniacal brine mixture slowly trickle down to meet an upward flow of carbon(IV)oxide gas.

The carbonator is shelved /packed with quartz/broken glass to

- (i) reduce the rate of flow of ammoniated brine/ammoniacal brine mixture.
- (ii)increase surface area of the liquid mixture to ensure a lot of ammoniated

brine/ammoniacal brine mixture react with carbon(IV)oxide gas.

Insoluble sodium hydrogen carbonate and soluble ammonium chloride are formed from the reaction.

### Chemical equation



The products are then filtered. **Insoluble** sodium hydrogen carbonate forms the **residue** while soluble ammonium chloride forms the **filtrate**.

Sodium hydrogen carbonate itself can be used:

- (i) as baking powder and preservation of some soft drinks.
- (ii) as a buffer agent and antacid in animal feeds to improve fibre digestion.
- (iii) making dry chemical fire extinguishers.

In the Solvay process Sodium hydrogen carbonate is then heated to form Sodium carbonate/soda ash, water and carbon (IV) oxide gas.

Chemical equation



Sodium carbonate is stored ready for use in:

- (i) during making glass/lowering the melting point of mixture of sand/SiO<sub>2</sub> from 1650°C and CaO from 2500°C to around 1500°C
- (ii) in softening hard water
- (iii) in the manufacture of soapless detergents.
- (iv) swimming pool “pH increaser”.

Water and carbon(IV)oxide gas are recycled back to the ammoniated brine/ammoniacal brine chamber.

More carbon(IV)oxide is produced in the kiln/furnace. Limestone is heated to decompose into Calcium oxide and carbon(IV)oxide.

Chemical equation



Carbon(IV)oxide is recycled to the carbonator/solvay tower. Carbon (IV)oxide is added water in the **slaker** to form Calcium hydroxide. This process is called **slaking**.

Chemical equation

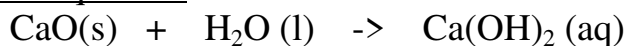

Calcium hydroxide is mixed with ammonium chloride from the carbonator/solvay tower in the **ammonia regeneration chamber** to form Calcium chloride , water and more ammonia gas.

Chemical equation

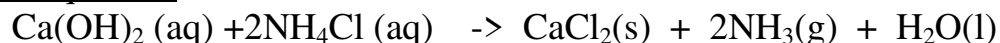

NH<sub>3</sub>(g) and H<sub>2</sub>O(l) are recycled.

Calcium chloride may be used:

- (i) as drying agent in the school laboratory during gas preparation (except ammonia gas)

(ii) to lower the melting point of solid sodium chloride / rock salt salts during the Downs process for industrial extraction of sodium metal.

**Detailed Summary flow diagram of Solvay Process**

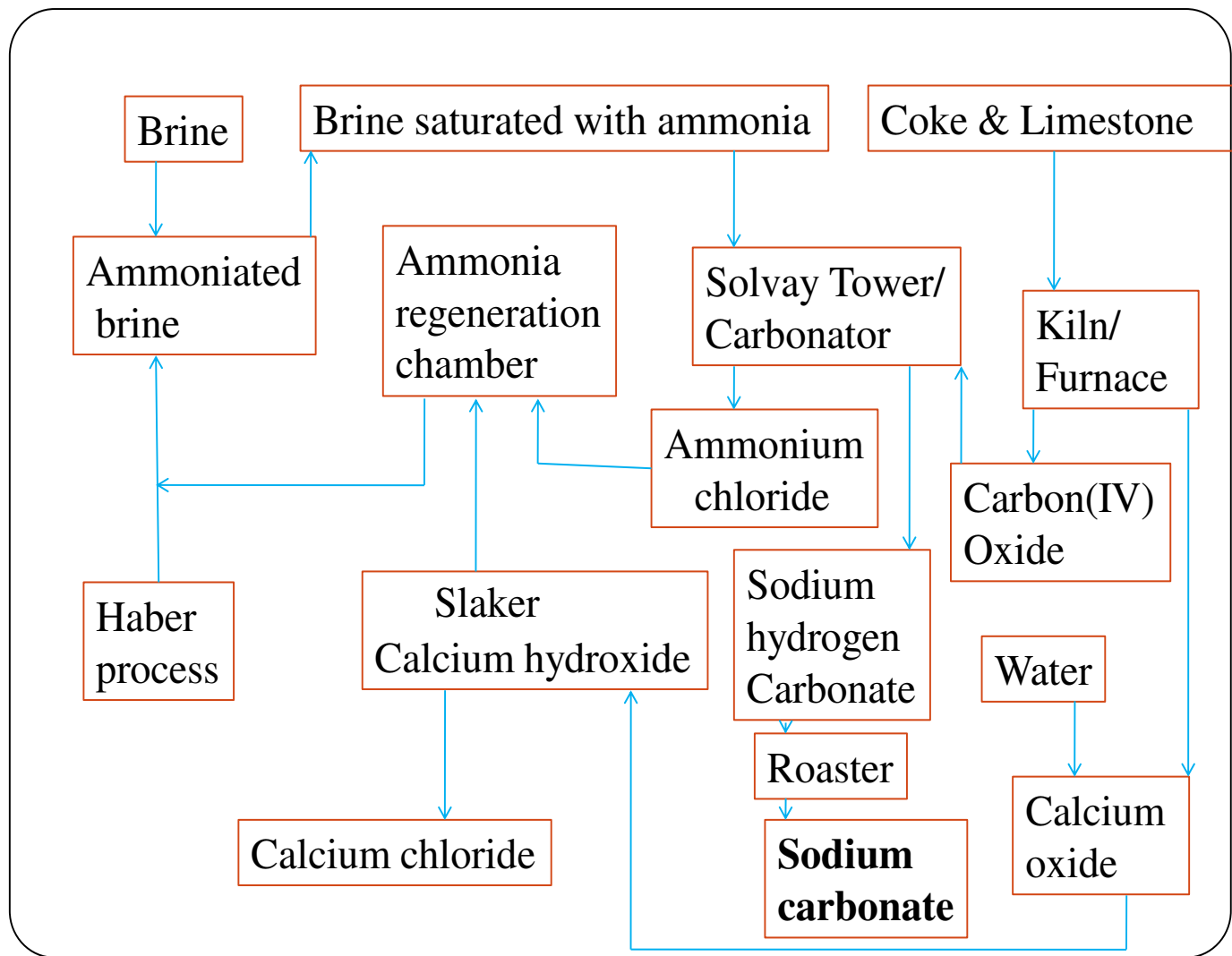

## Practice

1. The diagram below shows part of the Solvay process used in manufacturing sodium carbonate. Use it to answer the questions that follow.

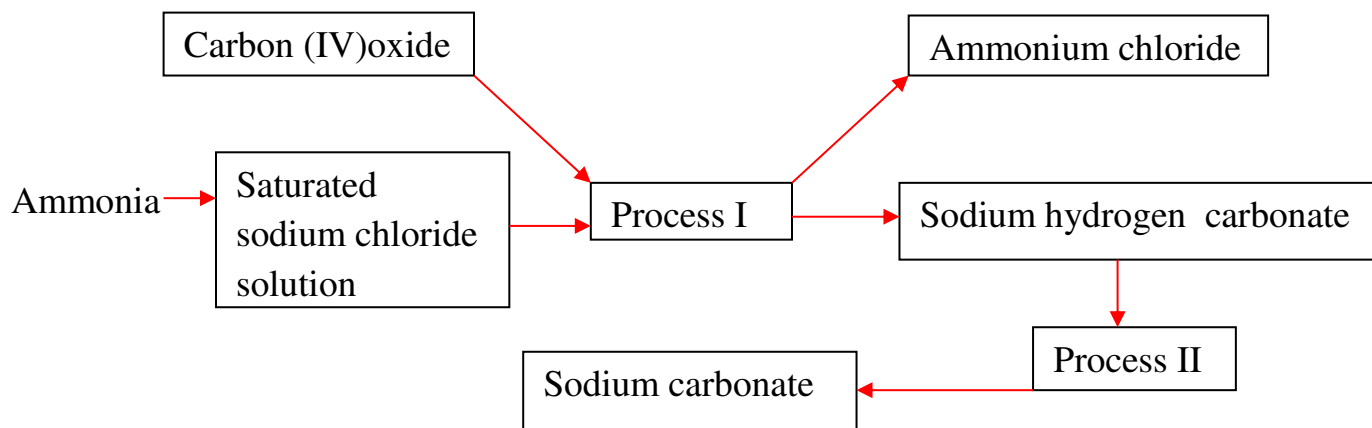

(a) Explain how Sodium Chloride required for this process is obtained from the sea.

Sea water is pumped /scooped into shallow pods. Evaporation of most of the water takes place leaving a very concentrated solution.

(b)(i) Name process:

- I. Filtration
- II. Decomposition

(ii) Write the equation for the reaction in process:

**Process I**

Chemical equation



**Process II**

Chemical equation



(c)(i) Name two substances recycled in the solvay process

Ammonia gas , Carbon(IV)Oxide and Water.

(ii) Which is the by-product of this process?

Calcium(II)Chloride /CaCl<sub>2</sub>

(iii) State two uses that the by-product can be used for:

1. As a drying agent in the school laboratory preparation of gases.
2. In the Downs cell/process for extraction of Sodium to lower the melting point of rock salt.



(iv) Write the chemical equation for the formation of the by-products in the Solvay process.

Chemical equation

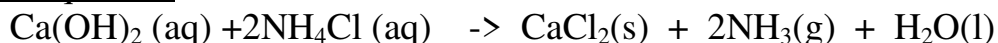

(d) In an experiment to determine the % purity of Sodium carbonate produced in the Solvay process, 2.15g of the sample reacted with exactly 40.0cm<sup>3</sup> of 0.5M Sulphuric(VI) acid.

(i) Calculate the number of moles of sodium carbonate that reacted.

Chemical equation



Mole ratio  $\text{Na}_2\text{CO}_3 : \text{H}_2\text{SO}_4 \Rightarrow 1:1$

$$\text{Moles H}_2\text{SO}_4 = \frac{\text{Molarity} \times \text{Volume}}{1000} \Rightarrow \frac{0.5 \times 40.0}{1000} = \underline{\underline{0.02 \text{ Moles}}}$$

Moles of  $\text{Na}_2\text{CO}_3 = \underline{\underline{0.02 \text{ Moles}}}$

(ii) Determine the % of sodium carbonate in the sample.

Molar mass of  $\text{Na}_2\text{CO}_3 = \underline{\underline{106\text{g}}}$

Mass of  $\text{Na}_2\text{CO}_3 = \text{moles} \times \text{Molar mass} \Rightarrow 0.02 \times 106 = \underline{\underline{2.12 \text{ g}}}$

% of  $\text{Na}_2\text{CO}_3 = \frac{(2.12 \text{ g} \times 100)}{2.15} = \underline{\underline{98.6047\%}}$

(e) State two uses of soda ash.

(i) during making glass/lowering the melting point of mixture of sand/ $\text{SiO}_2$  from 1650°C and CaO from 2500°C to around 1500°C

(ii) in softening hard water

(iii) in the manufacture of soapless detergents.

(iv) swimming pool “pH increaser”.

(f) The diagram below shows a simple ammonia soda tower used in manufacturing sodium carbonate. Use it to answer the questions that follow:

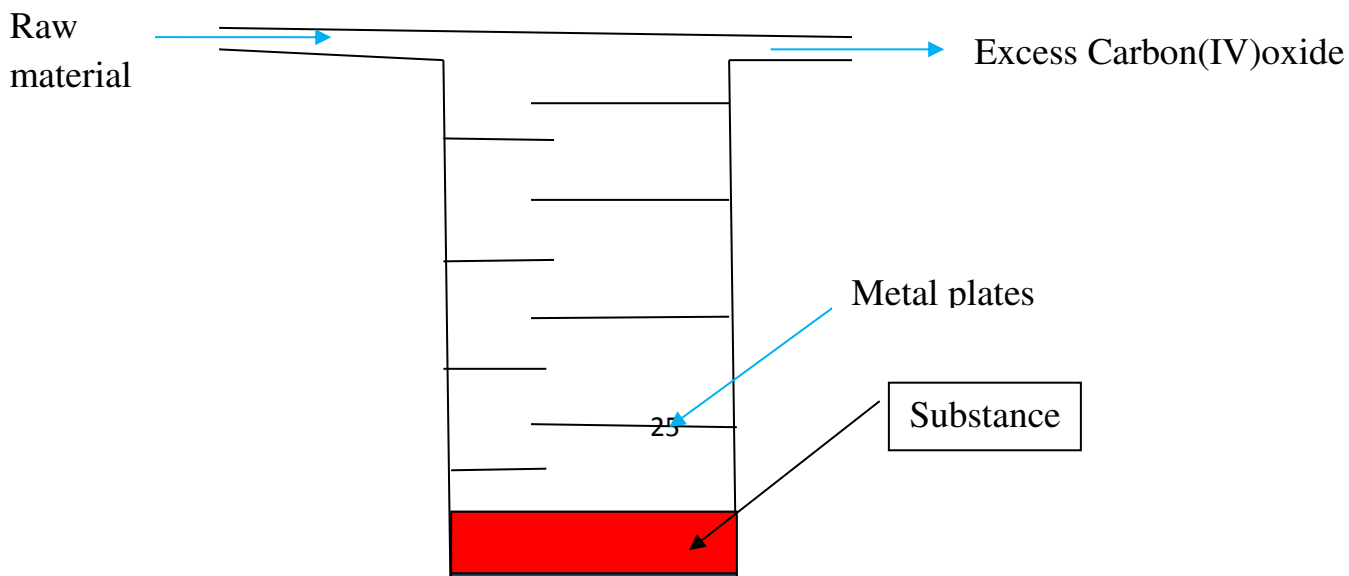

**(i) Name the raw materials needed in the above process**

- Ammonia
- Water
- Carbon(IV)oxide
- Limestone
- Brine/ Concentrated sodium chloride

**(ii) Identify substance A**

Ammonium chloride /NH<sub>4</sub>Cl

**(iii) Write the equation for the reaction taking place in:**

**I. Tower.**

Chemical equation



**II. Production of excess carbon (IV)oxide.**

Chemical equation

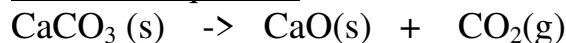

**III. The regeneration of ammonia**

Chemical equation

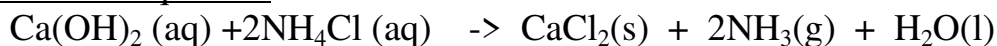

**(iv) Give a reason for having the circular metal plates in the tower.**

- To slow the downward flow of brine.
- To increase the rate of dissolving of ammonia.
- To increase the surface area for dissolution

**(v) Name the gases recycled in the process illustrated above.**

Ammonia gas , Carbon(IV)Oxide and Water.

**2. Describe how you would differentiate between carbon (IV)oxide and carbon(II)oxide using chemical method.**

Method I

- Bubble both gases in lime water/Ca(OH)<sub>2</sub>
- white precipitate is formed if the gas is carbon (IV) oxide
- **No** white precipitate is formed if the gas is carbon (II) oxide

Method II

- ignite both gases
- Carbon (IV) oxide does **not** burn/ignite
- Carbon (II) oxide burn with a blue non-sooty flame.

#### Method III

- Lower a burning splint into a gas containing each gas separately.
- burning splint is extinguished if the gas is carbon (IV) oxide
- burning splint is **not** extinguished if the gas is carbon (II) oxide.

### 3.Using Magnesium sulphate(VI)solution ,describe how you can differentiate between a solution of sodium carbonate from a solution of sodium hydrogen carbonate

- Add Magnesium sulphate(VI) solution to separate portions of a solution of sodium carbonate and sodium hydrogen carbonate in separate test tubes
- White precipitate is formed in test tube containing sodium carbonate
- No white precipitate is formed in test tube containing sodium hydrogen carbonate.

#### Chemical equation

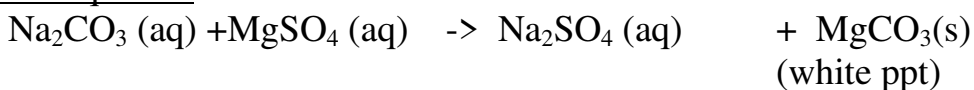

#### Ionic equation

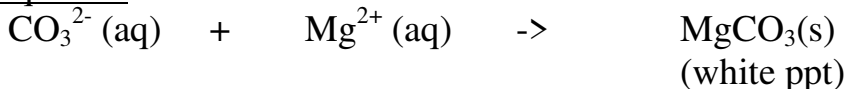

#### Chemical equation

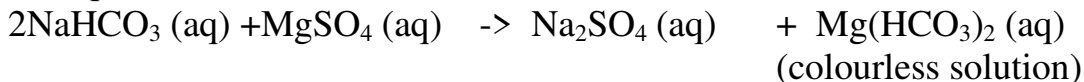

### 4. The diagram below shows a common charcoal burner .Assume the burning take place in a room with sufficient supply of air.

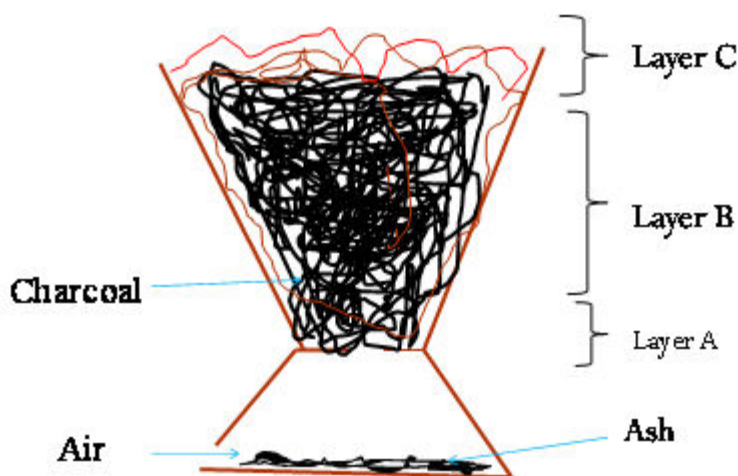

#### (a) Explain what happens around:

**(i)Layer A**

Sufficient/excess air /oxygen enter through the air holes into the burner .It reacts with/oxidizes Carbon to carbon(IV)oxide

Chemical equation

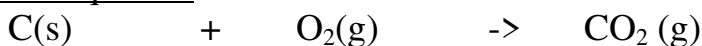

**(ii)Layer B**

**Hot** carbon(IV)oxide rises up and is reduced by more carbon/charcoal to carbon (II)oxide.

Chemical equation

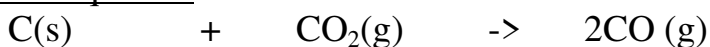

**(ii)Layer C**

**Hot** carbon(II)oxide rises up and burns with a blue flame to be oxidized by the excess air to form carbon(IV)oxide.

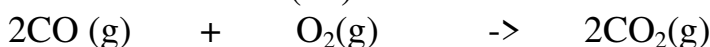

**(b)State and explain what would happen if the burner is put in an enclosed room.**

The hot poisonous /toxic carbon(II)oxide rising up will not be oxidized to Carbon(IV)oxide.

**(c)Using a chemical test , describe how you would differentiate two unlabelled black solids suspected to be charcoal and copper(II)oxide.**

Method I

- Burn/Ignite the two substances separately.
- Charcoal burns with a blue flame
- Copper(II)oxide does not burn

Method II

- Add dilute sulphuric(VI)acid/Nitric(V)acid/Hydrochloric acid separately.
- Charcoal does not dissolve.
- Copper(II)oxide dissolves to form a colourless solution.

**5. Excess Carbon(II)oxide was passed over heated copper(II)oxide as in the set up shown below for five minutes.**

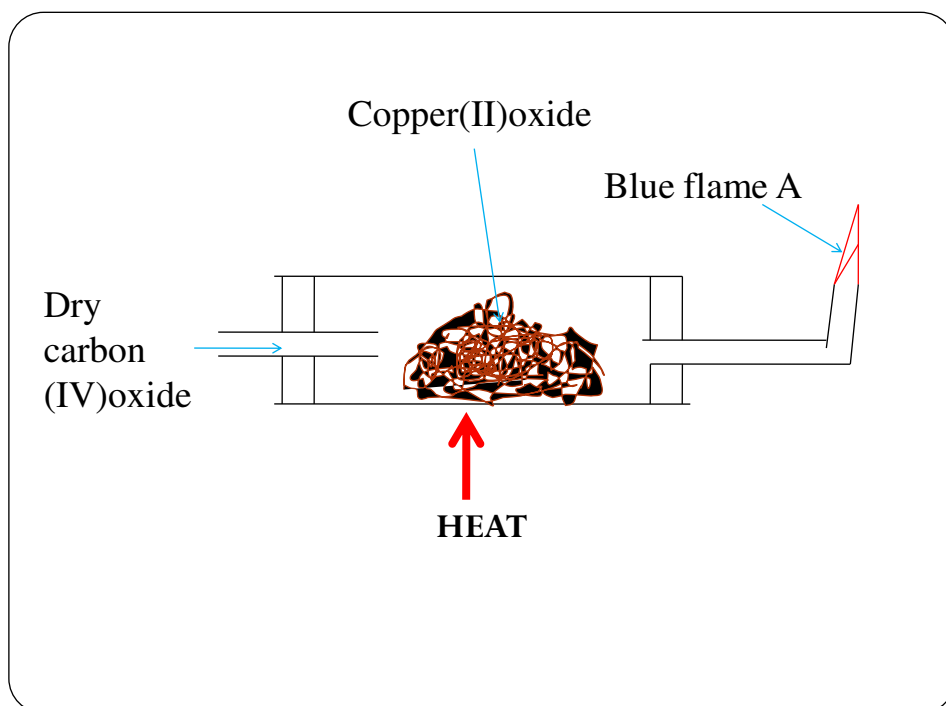

**(a) State and explain the observations made in the combustion tube.**

Observation

Colour change from black to brown

Explanation

Carbon (II)oxide reduces black copper(II)oxide to brown copper metal itself oxidized to Carbon(IV)oxide.

Chemical equation

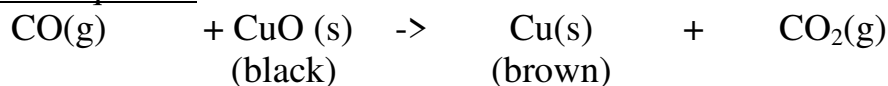

**(b) (i) Name the gas producing flame A**

Carbon(II)oxide

**(ii) Why should the gas be burnt?**

It is toxic/poisonous

**(iii) Write the chemical equation for the production of flame A**

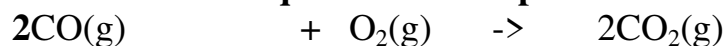

**(c) State and explain what happens when carbon(IV)oxide is prepared using Barium carbonate and dilute sulphuric(VI)acid.**

Reaction starts then stops after sometime producing small/little quantity of carbon(IV)oxide gas.

Barium carbonate react with dilute sulphuric(VI)acid to form insoluble Barium sulphate(VI) that cover/coat unreacted Barium carbonate stopping further reaction to produce more Carbon(IV)oxide.

(d) Using dot (.) and cross(x) to represent electrons show the bonding in a molecule of :

(i) Carbon(II)oxide

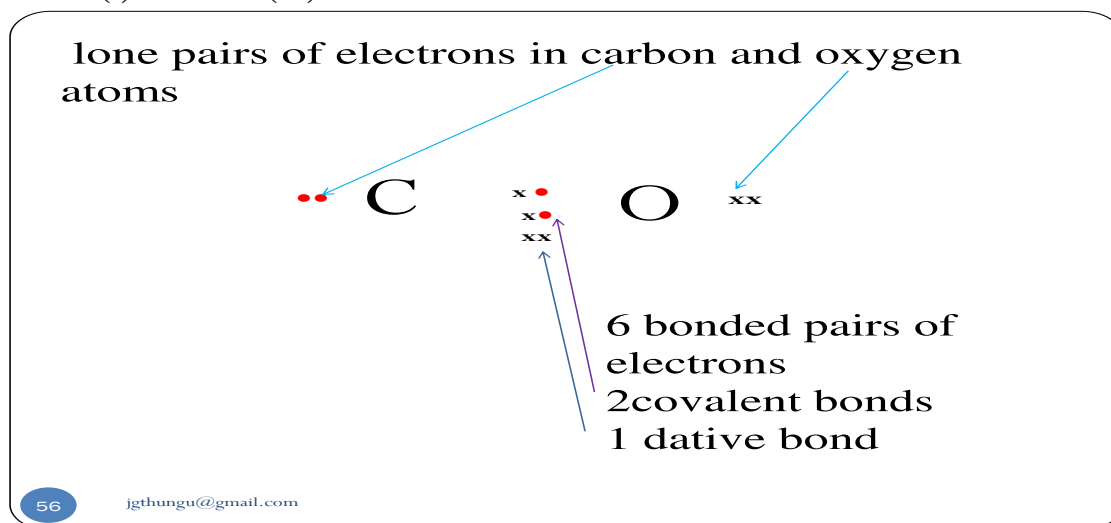

(ii) Carbon(IV)Oxide.

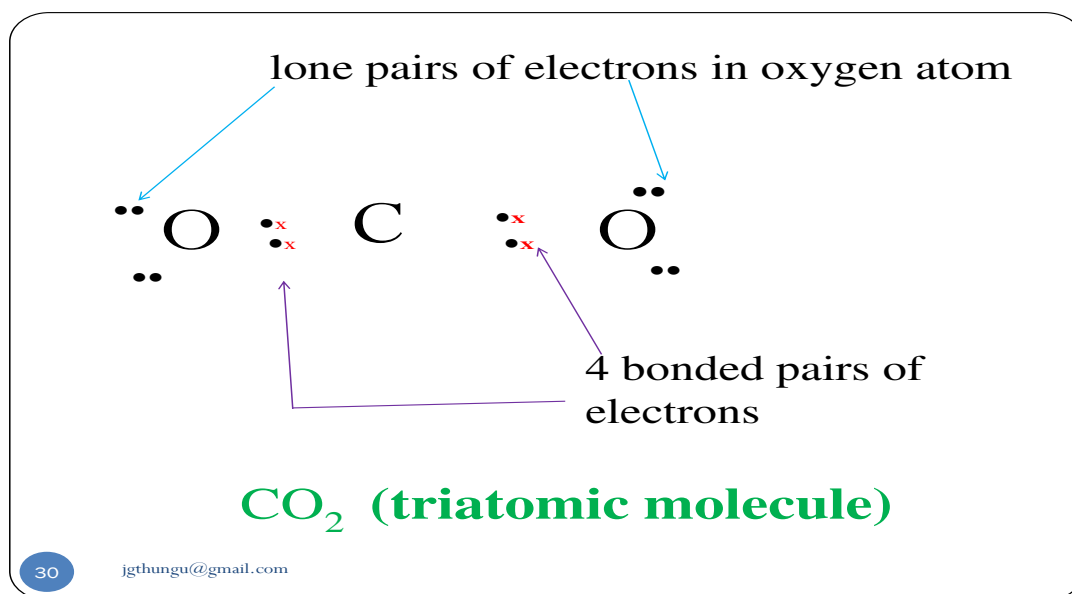

(e) Carbon (IV)oxide is an environmental pollutant of global concern.

Explain.

-It is a green house gas thus causes global warming.

-It dissolves in water to form acidic carbonic acid which causes “acid rain”

(f) Explain using chemical equation why lime water is used to test for the presence of Carbon (IV) oxide instead of sodium hydroxide.

Using lime water/calcium hydroxide:

- a visible white precipitate of calcium carbonate is formed that dissolves on bubbling excess Carbon (IV) oxide gas

Chemical equation

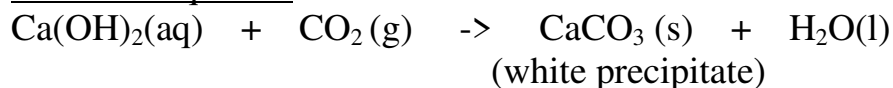

Using sodium hydroxide:

- **No** precipitate of sodium carbonate is formed Both sodium carbonate and sodium hydrogen carbonate are soluble salts/dissolves.

Chemical equation

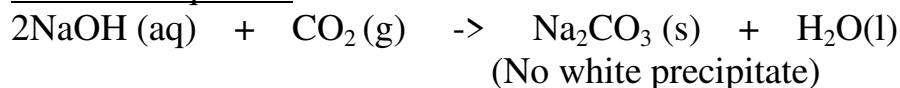

**(g)Ethan-1,2-dioic acid and methanoic acid may be used to prepare small amount of carbon(II)oxide in a school laboratory.**

**(i) Explain the modification in the set up when using one over the other.**

Before carbon(II)oxide is collected:

-when using methanoic acid, **no** concentrated sodium/potassium hydroxide is needed to absorb Carbon(IV)oxide.

-when using ethan-1,2-dioic acid, concentrated sodium/potassium hydroxide is needed to absorb Carbon(IV)oxide.

**(ii)Write the equation for the reaction for the formation of carbon(II)oxide from:**

**I.Methanoic acid.**



**II. Ethan-1,2-dioic acid**



**(h)Both carbon(II)oxide and carbon(IV)oxide affect the environment. Explain why carbon(II)oxide is more toxic/poisonous.**

-Both gases are colourless,denser than water and odourless.

-Carbon(II)oxide is preferentially absorbed by human/mammalian haemoglobin when inhaled forming stable carboxyhaemoglobin instead of oxyhaemoglobin.This reduces the free haemoglobin in the blood leading to suffocation and quick death. -

-Carbon(IV)oxide is a green house gas that increases global warming.

-Carbon(II)oxide is readily oxidized to carbon(IV)oxide

**6.Study the flow chart below and use it to answer the questions that follow.**

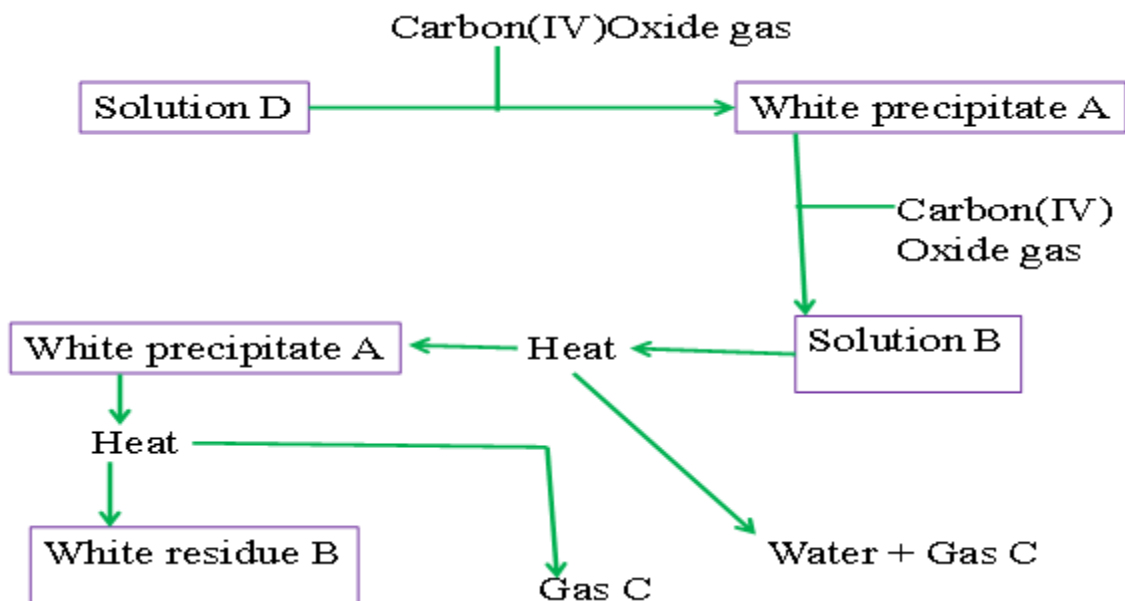

(a)Name:

- (i)the white precipitate A  
Calcium carbonate
- (ii) solution B  
Calcium hydrogen carbonate
- (iii) gas C  
Carbon(IV)oxide
- (iv) white residue B  
Calcium oxide
- (v) solution D  
Calcium hydroxide/lime water

(b)Write a balanced chemical equation for the reaction for the formation of:

(i) the white precipitate A from solution D

Chemical equation

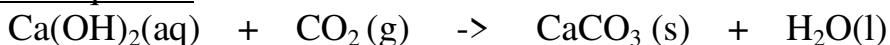

(ii) the white precipitate A from solution B

Chemical equation

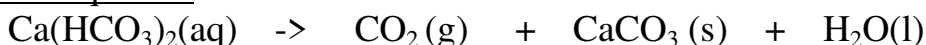

(iii) solution B from the white precipitate A

Chemical equation

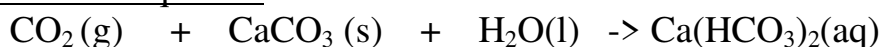



**(iv) white residue B from the white precipitate A**

Chemical equation



**(iv) reaction of white residue B with water**

Chemical equation

