



MINISTRY OF HEALTH

# Immunization Manual for Health Workers



# CONTENTS

FOREWORD .....	4
ACKNOWLEDGEMENTS .....	5
OBJECTIVES AND COMPONENTS OF THE UNIT OF VACCINES AND IMMUNIZATION .....	7
▪ Objectives and priorities of UVIS .....	8
▪ Immunization system components .....	9
IMMUNITY .....	12
VACCINE MANAGEMENT .....	21
▪ Target setting .....	22
▪ Vaccines forecasting .....	27
▪ Monitoring the use of vaccines .....	50
COLD CHAIN .....	54
▪ Cold chain equipment .....	56
▪ Basic principles of refrigeration .....	64
▪ Monitoring cold chain temperature .....	69
HOW TO ORGANIZE IMMUNIZATION IN THE HEALTH FACILITIES AND MOBILE/OUTREACH CLINICS .....	82
ENSURING THAT IMMUNIZATION INJECTIONS ARE GIVEN SAFELY .....	93
▪ Safe and unsafe injection .....	93
▪ Immunization waste management .....	100
▪ Adverse events following immunisation (AEFI) .....	104
KEPI VACCINES AND TECHNIQUE OF ADMINISTRATION .....	112
DATA MANAGEMENT, MONITORING AND EVALUATION .....	129
▪ Routine immunization indicators .....	130
▪ Collecting routine immunization data .....	133
DISEASE SURVEILLANCE .....	143
▪ Types of Disease Surveillance .....	144
▪ Surveillance Activities .....	144
▪ Standard Case Definitions for EPI targeted diseases .....	147
MAXIMIZING OPPORTUNITIES, COMMUNITY LINKAGES, AND COMMUNICATION	151
ANNEXES .....	166

# FOREWORD

The Unit of Vaccines and Immunization Services (UVIS) is an integral part of the Division of Family Health and an important component of the Maternal and Child Health Care services within the Ministry of Health.

In 1980, The Ministry of Health established the Kenya Expanded Programme on Immunization (KEPI) with the main aim of providing immunization against six killer diseases of childhood, namely tuberculosis, polio, diphtheria, whooping cough, tetanus and measles to all children in the country before their first birthday. Since the inception of the program, more vaccines have been added to the infant immunization schedule, namely hepatitis B, Hemophilus influenza type B vaccine, yellow fever and most recently the Pneumococcal vaccine. These vaccines address key killer diseases for children under the age of five years.

Recognizing that vaccination has been one of the most successful and cost-effective public health interventions, the Ministry of Health has consolidated all vaccination services under a single unit called the Unit of Vaccines and Immunization Services. This unit is now charged with the responsibility of managing all vaccines and related biologicals targeting people of all age groups.

The main challenge for the program is to ensure that the immunization services offered in this country are of high quality, acceptable, affordable and accessible to all Kenyans at all levels. For this to be achieved it is important that communities get more involved in the planning, implementation and monitoring of immunization services. This manual therefore has been reviewed and designed to address some of these issues. It will help the health worker or other relevant person who is offering the immunization services acquire the necessary knowledge and skills to effectively carry out the immunization services.

The manual covers all the basic components of EPI i.e. service delivery, vaccine quality and supply, logistics, VPD surveillance, advocacy, social mobilization and communication for immunization, management, and strengthening human and institutional resources.

The health facilities offering immunization services and medical training institutions will be supplied with copies of the manual. These will serve as reference book for the health workers, tutors, and students.

It is my sincere hope that the use of this Manual will help to improve the quality of immunization services throughout the country.

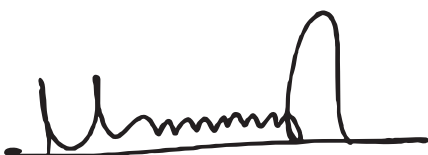

Dr. William K. Maina, OGW

**HEAD, DIRECTORATE OF PREVENTIVE & PROMOTIVE HEALTH SERVICES  
MINISTRY OF HEALTH**

# ACKNOWLEDGEMENTS

The EPI operational level manual is a product of efforts from several partners and individuals.

The Ministry of Health through the Unit of Vaccines and Immunization Services (UVIS) wishes to appreciate the support from all those who participated in the development of the manual. Special tribute goes to the Former head of DVI and the coordinator of training at Unit of Vaccines and Immunization – Dr. Kamau and Pamela Ochieng respectively for spearheading the process of reviewing this manual.

We would also wish to thank all those who were involved in the writing of the first edition of the manual of April 1982.

Special thanks go to USAID/MCHIP, WHO, and NESI for their continued technical support and funding of various activities and teams that sat to review the manual.

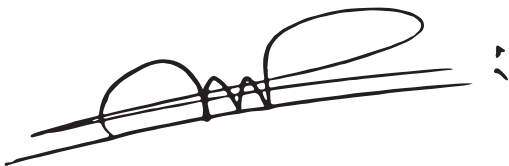

Dr. Ephantus Maree,

**HEAD of UNIT OF VACCINES AND IMMUNIZATION SERVICES**

# LIST OF CONTRIBUTORS

	<b>NAME</b>	<b>INSTITUTION / ORGANIZATION</b>
1.	DR. TATU KAMAU	DVI-MOH
2.	PAMELA OCHIENG	UVIS-MOH
3.	DR.EVANS MOKAYA	MCHIP
4	LORA SHIMP	MCHIP/HQ
5.	DR. ISAAC MUGOYA	MCHIP
6.	DR. COLLINS TABU	UVIS-MOH
7.	DR. JOHN OGANGE	WHO
8.	SUSAN OTIENO	MOH
9.	ERNEST SOME	UVIS-MOH
10.	PETER ADEMBA	UVIS MOH
11.	FLORENCE KABUGA	MOH –NAIROBI COUNTY
12	AMINA ISMAIL	MOH -DDSR
13	EDWARD MUMBO	MOH- KWALE COUNTY
14	BEATRICE KOKI	MOH
15	LOUSA MUTETI	MOH- MAKUENI COUNTY
16	CLEMENTINE GWOSWAR	MOH – MIGORI COUNTY
17	JUDITH SITI	MOI UNIVERSITY
18	S.M KAMAU	UVIS - MOH
19	DUNCAN SEDA	UVIS - MOH

# OBJECTIVES AND COMPONENTS OF THE UNIT OF VACCINES AND IMMUNIZATION SERVICES

## CHAPTER

# 1

**Introduction:** The immunization program is a global programme for the control of vaccine preventable diseases among children and people of all ages. In the Global Vaccine Action Plan (GVAP) of 2012, the global programme has set ambitious goals of eradicating and certification of a poliomyelitis free world by 2018, by 2020 Measles and rubella eliminated in at least 5 WHO regions, reach 90% national coverage and 80% in every district or equivalent administration for all vaccines in national programmes, and by 2020, the licensure and launch of vaccine or vaccines against one or more major diseases.

In Kenya, the Expanded Programme on Immunization (EPI) was launched in 1980 with the main aim of providing immunization against six killer diseases of childhood, namely tuberculosis, polio, diphtheria, whooping cough, tetanus and measles to all children in the country before their first birthday, and tetanus toxoid vaccination to all pregnant women. Prior to 1980 vaccination services had been provided on an ad-hoc basis mainly through primary schools and the larger health institutions. The programme has introduced into the infant immunization programme new vaccines notably; vaccines against hepatitis B virus and the hemophilus influenza type b bacteria in 2002, the ten valent pneumococcal conjugate vaccine in 2011.

Although the programme has not achieved optimal coverage in a number of districts, the overall impact of the programme has been a tremendous reduction in key vaccine preventable diseases, notably the elimination of diphtheria, the near elimination of pertusis, near eradication of poliomyelitis, marked reduction of diseases caused by the hemophilus influenza type b bacteria, and marked control of measles.

In order to improve on the immunization performance and sustain the gains achieved so far, more emphasis needs to be put on quality of services; by making the health workers are more knowledgeable on all aspects of immunization. The aim of this Manual is to serve as reference and training material for all health staff involved in immunization activities.

## Broad objectives

The reader will be able to understand the objectives, priorities and components of the programme.

## Specific objectives

The reader will be able to:

- Describe the objectives and priorities of the programme.
- Explain the components of the programme.

## Objectives and priorities of UVIS

### The Objectives of the Unit of Vaccines and Immunization Services

The Unit of Vaccines and Immunization Services exists to achieve the following objectives;

- To ensure equitable access to appropriate vaccination services for all persons in Kenya
- To ensure universal immunization of children in Kenya with appropriate doses of Ministry of Health prescribed childhood vaccines.
- To ensure universal immunization of special risk groups with Ministry of Health approved priority vaccines
- To ensure optimum vaccination service delivery in response to specific situations of outbreak of life threatening vaccine- preventable diseases

### Priorities

The priority activities for immunization programme are the following:

- Polio eradication
- Accelerated disease control
- Improving performance of routine Immunization
- Supplemental Immunization
- Improving financial flows
- Creating demand of immunization services through evidence-driven advocacy
- Improving the capacity of health workers



## Immunization System Components

The immunization system components include service delivery, vaccine supply, quality, logistics, disease surveillance and advocacy, communication and social mobilization.

### Service Delivery

UVIS programme endeavours to sustain and improve on the gains made over the years by providing quality immunization services. In Kenya, primarily most of immunizations take place in fixed posts UVIS uses different strategies to reach eligible clients. In addition to routine fixed strategy, outreaches and SIA play a role in improving service delivery.

### Vaccine Supply, Quality and Logistics

UVIS ensures that adequate vaccines as well as injection materials are procured through WHO/ UNICEF approved mechanisms (infant vaccines) as well as through the GoK procurement system (non-EPI vaccines). UVIS internal quality assurance mechanisms ascertain vaccine quality is maintained up to the point of utilization.

### Disease Surveillance

The Disease Surveillance and Response Unit (DSRU) is responsible for disease surveillance and response activities. UVIS will liaise closely with DSRU for all vaccine preventable diseases.

Vaccine preventable disease surveillance data (Polio, measles, PBM and MNT) is monitored so as to address gaps in immunization coverage in a timely manner as appropriate. In addition, data



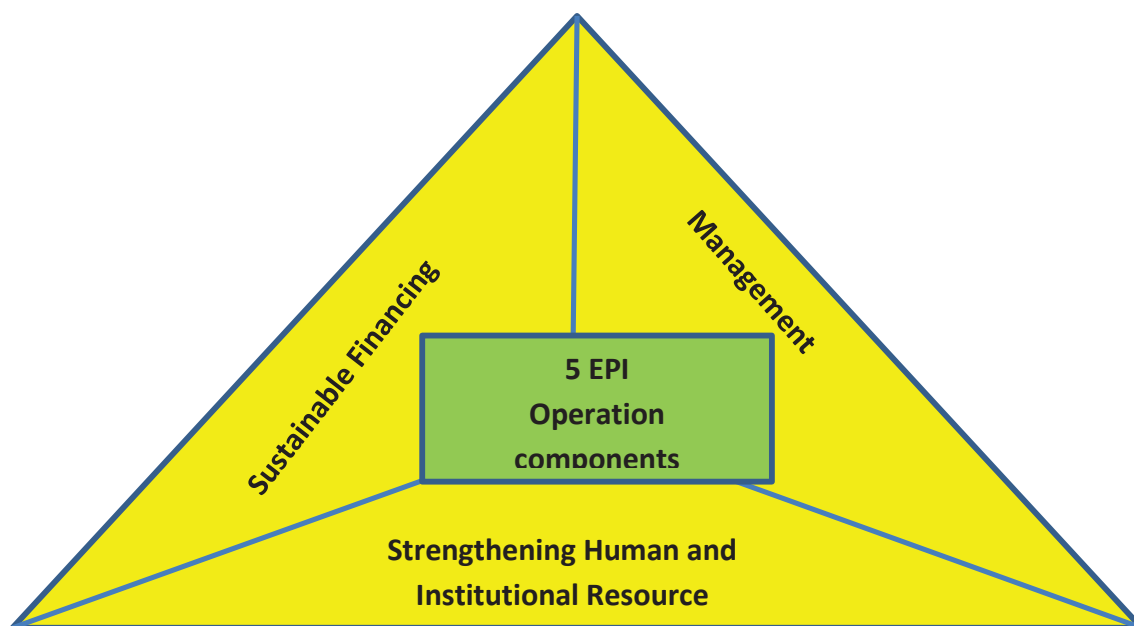

from Pneumococcal Bacterial Meningitis (PBM) and Rotavirus sentinel surveillance is monitored, analysed and used to inform decision making. Surveillance for other vaccines preventable diseases may be initiated as necessary.

## Advocacy, social Mobilization and Communication

Advocacy, social mobilization and communication are very crucial in EPI services. The advocacy unit at UVIS aims to assist in effective implementation of the planned activities as well as increase demand for service by communities. To this end, the unit develops and disseminates EPI communication plan for both routine immunization as well as SIAs. In addition, the unit develops key EPI messages for both the health workers and the community, which are disseminated through various channels and strategies.

## Supportive components

For the objectives of EPI to be realized, the five EPI operational components, three supportive components are required. These components are not specific to EPI but apply across the health system. These components are shown in the diagram below.

## Management

The management functions deals with people, resources and information. The roles of mangers include:

- Policy making
- Setting standards
- Coordination

- Information collection, analysis and sharing
- Initiating and managing collaborations/partnerships
- Quality assurance
- Monitoring and evaluation
- Supervision

## **Sustainable financing**

Vaccination services are expensive and often not adequately funded. For EPI programme to realize its goals and objectives there is need for sustainable financing. UVIS therefore has to have capacity to do the following:

- Budgeting
- Identifying funding sources
- Actions to increase resources allocation

These activities are meant to ensure that the programme activities are not disrupted due to lack of finances, especially for commodities as well as fuel that runs the cold-chain.

## **Human and institutional resources**

Like any medical field, immunization practices are constantly changing. The EPI programme must have the capacity to do the following

- Staffing
- Training
- Supervision
- Institutional support
  - *Technical information*
  - *Support to research projects*

Some of these functions e.g. staffing are carried by other departments in consultation with UVIS.

### **Broad Objectives**

The health workers at the end of this chapter they should be able to understand the mechanisms of immunity and immunization schedule.

### **Specific Objectives**

- Describe the cause of infections
- Explain how the body develops immunity
- Classification of vaccines

### **Introduction**

Immunity is the ability of the human body to tolerate the presence of materials indigenous to the body (self), and to eliminate foreign materials. This discriminatory ability provides protection from infectious disease, since most microbes are identified as foreign by the immune system. Immunity to a microbe is usually indicated by the presence of antibody to that organism. Immunity is generally specific to a particular organism or group of closely related organisms.

### **History of vaccination**

Over 200 years ago, Edward Jenner first demonstrated that vaccination offered protection against smallpox, by cutting an arm of a boy (James Phipps) and placing the materials from cowpox (mild disease) into the wound. Later, he injected the boy with fluid from smallpox and the boy did not contract the smallpox disease. This experiment led to the inoculation of persons with relatively harmless disease materials which could protect them from a more dangerous disease. This was called vaccination (“vacca” is Latin for cow). Since then the use of vaccines has continued to reduce the burden of many bacterial and viral diseases. Small pox has been eradicated, and poliomyelitis no longer occurs in many regions of the world as a result of widespread effective vaccination.

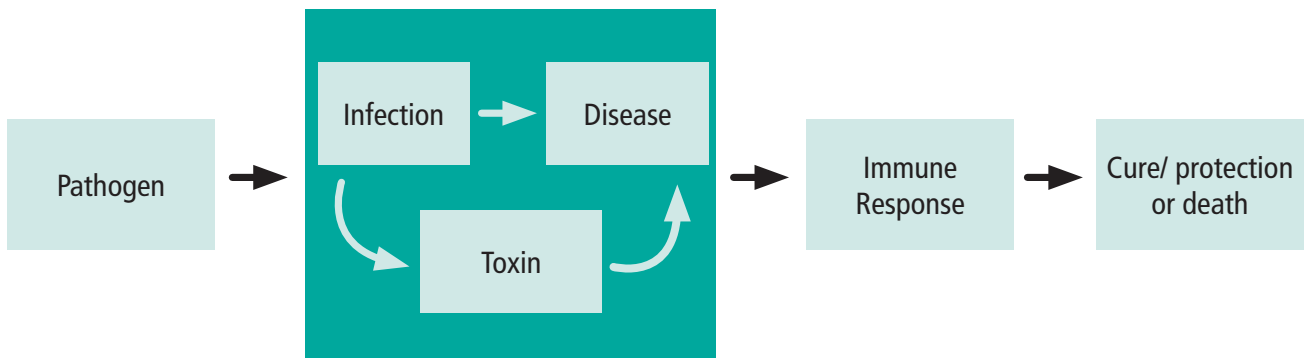

**Fig 2.1 Natural History Of Infection**

The first phase in the natural history of an infection is the progression from a healthy state to a disease state. This is marked by the entry and multiplication of infectious agent in the host.

Until typical signs and symptoms of the disease appear, the patient remains in a sub-clinical state.

The interaction between the pathogen or the pathogen's toxin and the body could result in disease. This phase is marked by the appearance of typical signs and symptoms of the disease. The interval between exposure to an infectious agent and onset of clinical disease is called the *incubation period*.

The outcome of the infection depends on how well the body handles the pathogen or the toxin. This phase is marked by either a full recover, recovery with disability or death

## The cause of infections

Infections are caused by organisms which get into the body through inhalation, ingestion, or penetration of the skin/mucus membrane. These organisms multiply in the body tissues/blood and cause illness. Disease causing organisms include: bacteria, viruses, parasites and fungi. Some microorganisms produce chemicals called toxins, which cause illnesses.

## How the body develops immunity

There are two basic ways to acquire immunity against infections – active immunity and passive immunity.

1. Active immunity is acquired when a person's own immune system is stimulated to produce antigen specific antibodies and immune cells. This type of immunity often lasts for many years and it may be permanent. Active immunity can be divided into **Natural active immunity** and **Artificial active immunity**

2. Passive immunity, results when antibodies are transferred from one person or animal to another. Passive immunity disappears over time and usually within weeks or months. It is divided into **natural passive immunity** and **artificial passive immunity**.

### *a) Natural Active Immunity*

This is the immunity acquired after an individual has survived an infection with the disease causing form of the organism. When a foreign particle or organism invades the body, white blood cells called lymphocytes identify the substance, also referred to as the antigen. The white blood cells produce antibodies, which when are in sufficient quantities, are able to identify the antigens and kill them or inactivate them. The patient recovers and the body's lymphocytes keep the memory of these organisms for life. This means that next time the same organism attacks the patient, the lymphocytes are ready to produce large amount of antibodies, which will overcome the organism. The patient will not get ill again hence he/she is said to have acquired natural immunity. For example, if a child has had measles and recovered, the child's lymphocytes produce antibodies any time the child encounters the measles virus throughout the child's life.

### *b) Artificial Active Immunity*

This is the type of immunity given through vaccine administration. A vaccine is made from an organism which is either killed or attenuated, that means it has lost its harmfulness, or its part or toxin rendered harmless ("toxoid"). However, its antigenicity will still be identified by lymphocytes and will induce production of antibodies. For example if a child gets the oral polio vaccine (attenuated live polio virus), the child's body will produce antibodies against poliovirus and hence will be protected against poliomyelitis without having been sick.

**Fig 2.2 Action of Vaccine**

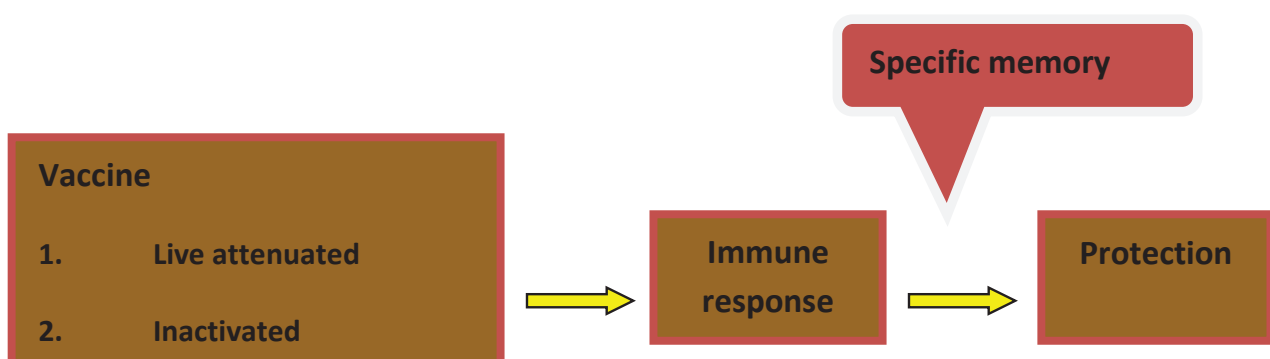

### *c) Natural Passive Immunity*

Passively acquired antibodies are responsible for the protection of newborns and young infants against certain diseases. The transfer of antibodies from mother to foetus across the placenta during the last 2-3 months of pregnancy provides the newborn with a portion of the mother's immunological experience. Examples of passive transfer occur when:

- Tetanus antibodies induced in the mother following immunization with tetanus toxoid easily passes across the placenta to the unborn child providing protection against tetanus in the neonatal period.
- Measles antibodies made by the mother, passes through the placenta and breast milk, protecting the newborn during the first months of life.
- Protection is better against some diseases (e.g. measles, rubella, tetanus) than others (e.g. polio, pertussis)

#### *d) Artificial Passive Immunity*

“Borrowed” antibodies can also protect one temporarily. These borrowed and prepared antibodies are from serum (antiserum) of person or animal that has been exposed to an antigen and has produced antibodies which are purified and are directly injected to the person at the site of infection to immediately counteract the offending antigen. Sources of passive artificial immunity include blood and blood products, immune or hyper-immune globulin, and animal antitoxins.

**Table 2.1 Comparison of the different types of immunity**

	NATURAL ACTIVE IMMUNITY		ARTIFICIAL ACTIVE IMMUNITY	
Active Immunity	Cause	Infection	Cause	Immunisation with modified antigen
	Advantage	Life long immunity	Advantage	Long lasting protection
	Disadvantage	Risk from dying from infection e.g. Measles	Disadvantage	No immediate protection (varies from 3-4weeks)
	NATURAL PASSIVE IMMUNITY		ARTIFICIAL PASSIVE IMMUNITY	
Passive Immunity	Cause	Antibodies from mother’s blood	Cause	Borrowed antibodies from human or animal source (antiserum)
	Advantage	Immediate protection	Advantage	Immediate reaction
	Disadvantage	Short lasting immunity	Disadvantage	Adverse reaction may occur

## Herd Immunity

This is the protective effect accorded to the few individuals who have not been immunized in a community that has a high proportion of immunized population. Herd immunity usually depends upon a high percentage of children immunized, evenly distributed in a given area. A community becomes susceptible to the disease if a large number of people who are not immune enter it either by birth or immigration (e.g. when an influx of unvaccinated refugees occurs in an area). There are two ways of developing herd immunity:

- High natural infection rate in the community.
- Artificial immunization.

## Types of Vaccines used in by the Kenya UVIS

There are three types of vaccine:

- Live attenuated vaccines
- Inactivated vaccines – either whole cell or cell fractions
- Genetically engineered ( recombinant) vaccines – which are similar to inactivated vaccines

### Live attenuated vaccines

Live attenuated vaccines are derived from disease-causing viruses or bacteria that have been weakened under laboratory conditions. They will multiply in a vaccinated individual, but because they are weak, either cause no disease or only a mild form. Usually, only one dose of this type of vaccine provides life-long immunity, with the exception of oral polio vaccine, which requires multiple doses.

Examples of live attenuated vaccines include:

- Virus: oral polio vaccine (OPV), measles, yellow fever
- Bacteria: BCG, oral typhoid (*Salmonella typhi*) and oral cholera

### Inactivated vaccines

Inactivated vaccines are produced by growing viruses or bacteria and then inactivating them with heat or chemicals. Because they are not alive, they cannot grow in a vaccinated individual and therefore cannot cause the disease. Since they are not as effective as live vaccines, multiple doses are required for full protection. Booster doses are needed to maintain immunity because protection by these vaccines diminishes over time.

Inactivated vaccines may be whole-cell or cell fractions. Whole-cell vaccines are made of an entire bacterial or viral cell. On the other hand, polysaccharide-based vaccines are composed of long chains of sugar molecules taken from the surface capsule of the bacteria. Unless coupled with a protein, pure polysaccharide vaccines are generally not effective in children under the age of two years. This coupling process is known as “conjugation”.

**Recombinant** vaccines are produced by inserting genetic material from a disease-causing organism into a harmless cell, which replicates the proteins of the disease-causing organism. The pro-



teins are then purified and used as vaccine. Examples of inactivated vaccines include:

- Whole inactivated viral vaccines, e.g. Smallpox, Injectable Polio Vaccine (IPV) (Salk), hepatitis A, Influenza, rabies
- Whole inactivated bacterial vaccines, e.g. whole-cell pertussis, inactivated cholera, anthrax
- Subunit and fractional vaccine - These vaccine are composed of parts (i.e. subunits or fractions) of the pathogen, instead of the whole pathogen, e.g.
  - *Fractional: Diphtheria and tetanus toxoids, Haemophilus influenzae type b conjugate vaccine (Hib), pneumococcal conjugate vaccine (PCV)*
  - *Recombinant: Hepatitis B, HPV*

## The National Infants Immunization Schedule

The Kenya National Immunization Schedule consists of five contacts between birth and 9 months. If a child is seen for the first time later than the scheduled age, the child must catch up with immunizations. All the vaccines for which the child is eligible at an earlier age can be given together anytime you come in first contact with the child. For example, 3 months old baby should be given BCG, OPV 1, DPT+HepB-Hib1 and PCV1 vaccines immediately and parents/ guardian should be explained the need of another appointment 4 weeks later until the child finishes all the immunizations. If the child is 9 months, or older should be given BCG, OPV1, DPT/HepB –Hib1, PCV1 and measles vaccines.

FIGURE 2.3 THE NATIONAL IMMUNIZATION SCHEDULE

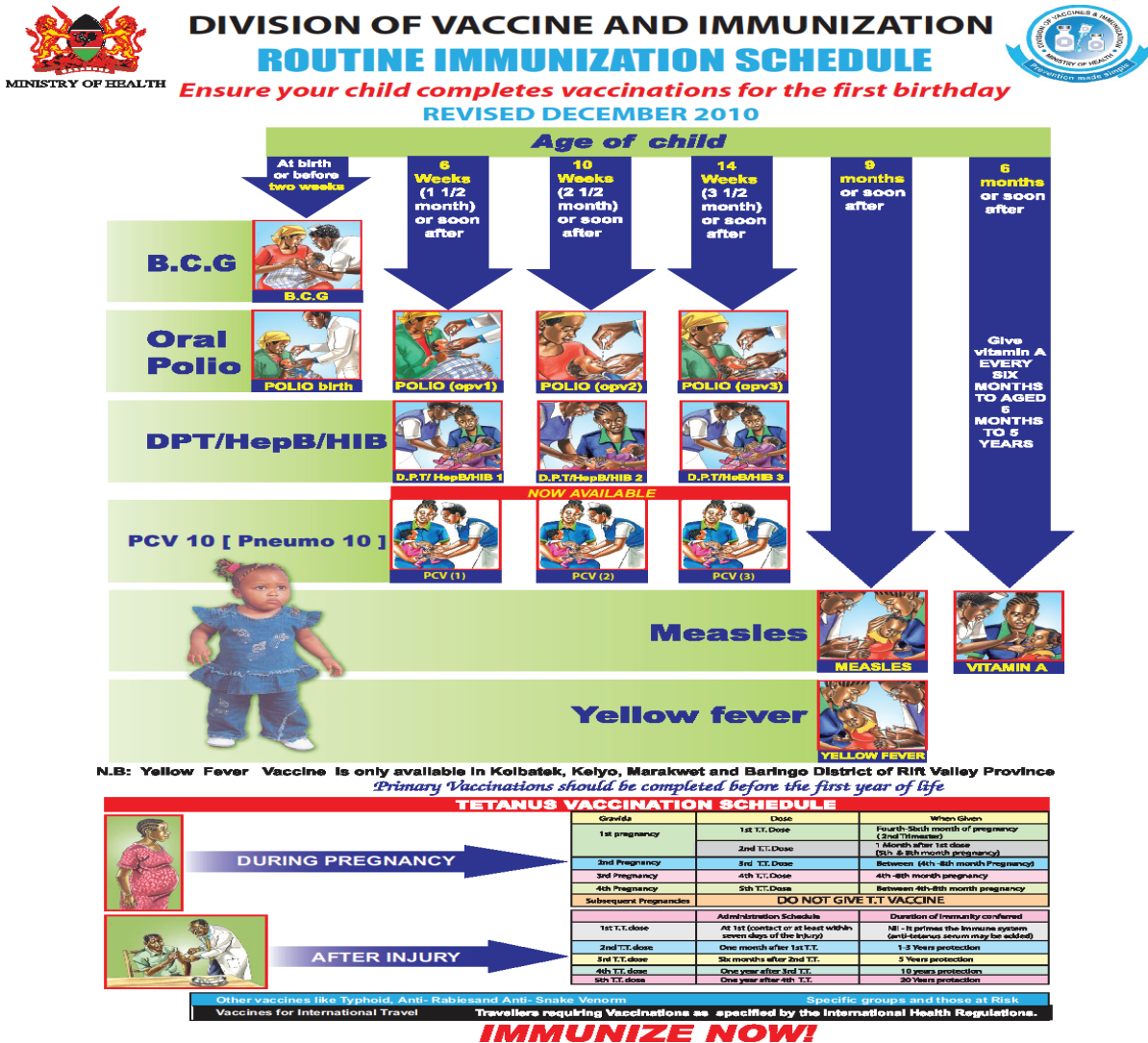

There is an *optimal* age for each vaccine: BCG and OPV0 are given at birth. DPT+HepB-Hib and pneumococcal vaccines should be commenced at age 6 weeks. If given earlier, they will not provide protection. **Measles vaccine should not be given before nine months** because of the presence of significant blood levels of maternal antibodies that lower its efficacy.

All series antigens, the three doses of OPV, DPT+HepB-Hib and PCV should be given *one month apart* to let the child's immune system process the previous dose and produce the best antibody response. If the mother comes later than four weeks after the previous dose, the doses should be continued. **DO not restart the schedule since there is no maximum interval between doses** and the vaccine will be as effective as if given after four weeks; however encourage the mother not to forget the next appointment.

**Remember: Do not miss an opportunity to immunize when you see an eligible**

**TABLE 2.3** SUMMARY OF CHILDHOOD IMMUNIZABLE DISEASES

Disease	Pathogen – route of transmission	Mode of transmission	Clinical presentation/*standard case definition	Prevention through vaccination (schedule of vaccinations)
Tuberculosis	Bacteria; Mycobacterium tuberculosis	Droplet transmission	Commonly Unspecific in younger children. The only sign of pulmonary TB may be stunted growth or failure to thrive	BCG – at birth
Diphtheria	Bacteria; Corynebacterium diphtheria	Droplet transmission	An illness characterized by laryngitis or pharyngitis or tonsillitis and the presence of an adherent membrane of the tonsils, pharynx, and/or nose.	Diphtheria vaccine – 6, 10, 14 weeks
Pertusis	Bacteria; Bordetella pertusis	Droplet transmission	A person with a cough lasting at least two weeks with at least one of the following: <ul style="list-style-type: none"> <li>• Fits of coughing (paroxysm)</li> <li>• Intake of breath accompanied by a whooping sound</li> <li>• Vomiting immediately after coughing and without any other apparent cause</li> </ul>	Pertusis vaccine – 6, 10, 14 weeks
Tetanus	Bacteria - Clostridium tetanii	Wound/ cut Contamination with soil and feces containing the bacteria	Neonatal Tetanus: Any neonate with a normal ability to suck and cry during the first two days of life, AND who, between 3 and 28 days of age, cannot suck normally AND becomes stiff or has spasms (i.e., jerking of the muscles), or both.	Tetanus vaccine – 6, 10, 14 weeks
Haemophilus Influenza type b disease	Bacteria- Haemophilus Influenza type b	Droplet transmission	Bacterial meningitis is characterized by acute onset of fever, headache, and stiff neck.  Note: Meningitis is not specific for Hib disease, and Hib disease cannot be diagnosed on clinical grounds.	Hib vaccine – 6, 10, 14 weeks
Hepatitis B	Hepatitis virus	. Vertical transmission  . Horizontal transmission  . xxxxxSexual transmission	Acute jaundice (yellow skin or a yellow colour in the whites of the eyes), dark urine, anorexia, malaise, extreme fatigue, and right upper quadrant tenderness. (None of these symptoms is common in infants and young children.). Most children are asymptomatic and are likely to be chronic carriers.	Hepatitis vaccine -6, 10, 14 weeks

Disease	Pathogen – route of transmission	Mode of transmission	Clinical presentation/ <sup>xxx</sup> standard case definition	Prevention through vaccination (schedule of vaccinations)
Measles	Measles virus	Droplet transmission	Any person with fever and maculopapular rash (i.e., non-vesicular or without fluid) and either cough, coryza (i.e., runny nose), or conjunctivitis (i.e., red eyes).	Measles vaccine – 9 months
Polio	Polio virus	Faecal – oral transmission	Any case with weakness or floppiness in the limb(s) of sudden onset not due to clear history of trauma, in a child less than 15 years of age or any case in whom a clinician suspects poliomyelitis as a possible diagnosis regardless of age.	Polio vaccine – birth, 6, 10, 14 weeks
Pneumococcal disease	Streptococcus	Droplet transmission	Varies with the syndrome; Bacterial Meningitis, pneumonia, bacteremia, sinusitis etc	PCV vaccine – 6, 10, 14 weeks
Rotavirus Diarrheal disease	Rotavirus	Faecal – oral transmission	Watery diarrhoea	Rotavirus vaccine – 6, 10 weeks*
Yellow Fever	Yellow fever virus	Bite by an infected Aedes Mosquito	Fever, chills, headache, backache, general muscle pain, upset stomach, and vomiting. As the disease progresses, the person becomes slow and weak. There may be bleeding from the gums and blood in the urine. Jaundice Black vomiting may also occur.	Yellow Fever Vaccination – 9 months

<sup>xxxx</sup> – Unlikely mode of spread in children

# VACCINE MANAGEMENT

## CHAPTER 3

The effectiveness and success of KEPI in reducing the burden of immunization preventable diseases depends on the quality of vaccines at the point of use, which in turns reflects the usefulness of the vaccine management system.

In order to reduce mortality, morbidity and disability, immunization session must safely administer potent vaccines to susceptible children and women before they are exposed to immunization preventable diseases.

The immunization programme aims at resolving vaccine and management problems include:

- Reduction of the incidences of overstocking or under stocking of vaccines
- Ensuring proper accountability for all vaccines at all levels
- Reduction of vaccine wastages

Storing too much vaccine for more than the recommended storage period increases the risk of some vaccine reaching its expiration. In contrast under stocking will lead to stock out and eventually the missed opportunity.

To be sure that the appropriate amount of vaccine is available, vaccine stocks must be checked continuously, and records kept of all movement of stock in and out of storage areas

### **Broad Objective**

The purpose of this chapter is to update health workers with concepts and techniques of vaccine management

## Specific Objectives

At the end of this chapter, the health worker shall be able to

- carry out target setting
- forecast vaccine needs based on the target population
- order vaccines according to minimum/maximum stocking policy
- manage vaccines stocks by controlling the movement, arrangement, storage of vaccines and supplies and conducting inventory / physical stock of vaccines
- monitor vaccine use by interpreting Vaccine Vial Monitor and applying the Multi-Dose Vial Policy during immunization sessions
- monitor and reduce the vaccine wastages.

## Target Setting

### Setting Divisional Immunization Coverage Targets

Each division is expected to set targets for two population categories

- Children less than 1 year
- Women of child bearing age

The tool for target setting is shown in figure 3.1. A separate copy of this tool to set target for each of the two population categories.

The following steps should be taken:

Decide on the population category you are setting target for. It can be

- Children less than 1 year
- Women of child bearing age

Having decided, fill the appropriate space in the target setting form.

**FIGURE 3.1 TOOL FOR TARGET SETTING**

**FIGURE xxx: IMMUNIZATION COVERAGE TARGET SETTING FORM**

**Name of the Division** \_\_\_\_\_ **Target for Year** \_\_\_\_\_

Population Category \_\_\_\_\_  
(Children less than 1 year OR CBA Women)

Indicator antigen \_\_\_\_\_  
(DPT/HepB + HIB-1 OR Tetanus Toxoid)

**SECTION 1: Calculating the Divisional Targets**

<b>A</b>	<b>B</b>	<b>C</b>	<b>D</b>	<b>E</b>	<b>F</b>	<b>G</b>	<b>H</b>
<b>Total Pop for last year</b>	<b>Annual Total Pop Growth Rate (%)</b>	<b>Estimated Increase in population this year</b>	<b>Total pop this year</b>	<b>Proportion of total pop making up the pop category</b>	Estimated number of people in the pop category in new-year (children < 1 year or Pregnant women)  <b>D x E/100</b>	Estimated number of people in the pop category to be vaccinated each Month in new-year  <b>F/12</b>	Number of people in the pop category vaccinated in the last year
		<b>A x B/100</b>	<b>A + C</b>				

**SECTION 2: Calculating the Health Facility Targets**

<b>I</b>	<b>J</b>	<b>K</b>	<b>L</b>	<b>M</b>	<b>N</b>	<b>O</b>
S / N	Name of the Facility	Number of people in the pop category vaccinated last year	Percent Contribution to divisional total last year  <b>K/H x 100</b>	Calculated Number of people to be vaccinated this year  <b>F x L/100</b>	Adjusted Number of people to be vaccinated this year <b>(Based on the judgment of head of health facility)</b>	Number of people in the pop category to be vaccinated each Month <b>(N/12)</b>
	<b>TOTAL</b>					

Determine the indicator antigen you want to monitor. Depending on the population category you are setting target for, this can be

- DPT+HepB / HIB-1 (for children under than 1 year old) or
- Tetanus Toxoid (TT) – For CBAW

Then fill in the antigen in the space provided in the target setting form.

Having determined the population category, the following steps should be taken in setting targets for that particular population category. The target setting examples that follow are for children under one year of age.

Obtain the total population of the division for last (outgoing) year and fill column A.

### *Utopia Division in Fictitia County Example:*

**Total population for 2002 = 27,242**

Use the annual total population growth rate to fill column B

### *Utopia Division Example:*

**The annual population growth rate for Fictitia County = 5%**

Estimate the increase in the population expected in the new-year. Thus the new-year population will be above the outgoing year population by this number. This is done as follows:

Multiplying the outgoing year population (column A) by the annual growth rate (column B). Fill column C

### *Utopia Division Example:*

**The population increase =  $(27,242 \times 5) / 100 = 1,367$**

Estimate the total population of the division for the new-year by adding the total population for last/outgoing year (column A) to the population increase (column C). Fill column D.

### *Utopia Division Example:*

**Estimated total population for new-year (2003) =  $27,242 + 1,362 = 28,604$**

Fill column E with the proportion of the total population that make up the population category of interest. In Eldorado country where Utopia division is, the current proportions are:

For children less than 1 year = 4%

- For CBAW = 24%

Estimate the number of people in the population category in the division for the new-year by multiplying the total estimated population for the new-year (column D) by the proportion making up the population category (column E). Fill column F.

### *Utopia Division Example:*

**Estimate of the number of children less than 1 year for new-year (2003) =  $(28,604 \times 4)/100 = 1,144$**

Determine the number of people in the selected population category to be vaccinated each month in the division by dividing the estimated total number of children under 1 year for the new-year (2003) by 12 months



**Utopia Division Example: The number of children to be vaccinated each month = 1,144/12 = 96**

Determine the total number of children less than 1 year vaccinated in the division in the outgoing year. Fill column H.

This is the same as the total doses of DPT+HepB-HIB-1 given in the division in the previous year. Get this from the summary of the divisional immunization data carried out in step 1

*Utopia Division Example:*

**The number of children given DPT+HepB-HIB-1 in 2002 = 1,061**

## Assigning Targets to health facilities

The number of children less than 1 year and CBAW to be vaccinated in the division in the new-year has been determined. Since all the health facilities providing immunization services in the division will contribute to the division's target populations, these target populations will be distributed among the contributing health facilities.

The number of children less than 1 year or CBAW assigned to each health facility should be based on:

- Proportional contribution of each health facility to the division's achievement in the previous year
- Knowledge of the population density around each health facility
- Consensus among all the contributing health facilities

The following steps should be taken by all the constituent health facilities working together

List each health facility in column J.

Get names from the summary of the divisional immunization data carried out in step 1

*Utopia Division Example: See figure 3.2*

Fill the number of people in the population category (children less than 1 year or CBAW) vaccinated in the previous year in column K for each health facility listed

Get the data for each health facility from the summary of the divisional immunization data carried out in step 1

## Utopia Division Example:

- **Gituamba Health Center:** Children under one year vaccinated last year = 150. (See figure 3.2)

Calculate the percentage contribution of each health facility to the division's achievement in the previous year. To do this, **divide the number of the people in the population category vaccinated last year in the health facility (column K) by the total number of people in the population category vaccinated last year in the division (column H) and multiply by 100.** Fill column L.

**FIGURE 3.2: UTOPIA DIVISION EXAMPLE**

FIGURE 3: UTOPIA DIVISION EXAMPLE OF IMMUNIZATION COVERAGE TARGET SETTING							
Name of the Division _____ Utopia _____ Target for Year ___2003_____							
Population Category ___Children less than 1 year_____							
(Children less than 1 year OR CBA Women)							
Indicator antigen _____DPT/HepB + HIB-1_____							
(DPT/HepB + HIB-1 OR Tetanus Toxoid)							
<b>SECTION 1: Calculating the Divisional Targets</b>							
A	B	C	D	E	F	G	H
Total Pop for last year	Annual Total Pop Growth Rate (%)	Estimated Increase in population this year	Total pop this year	Proportion of total pop making up the pop category (%)	Estimated number of people in the pop category in new-year (children < 1 year or Pregnant women)	Estimated number of people in the pop category to be vaccinated each Month in new-year	Number of people in the pop category vaccinated in the last year
		$A \times B/100$	$A + C$		$D \times E/100$	$F/12$	
27,242	5	1,367	28,604	4	1,144	96	1,061
<b>SECTION 2: Calculating the Health Facility Targets</b>							
I	J	K	L	M	N	O	
S / N	Name of the Facility	Number of people in the pop category vaccinated last year	Percent Contribution to divisional total last year	Calculated Number of people to be vaccinated this year	Adjusted Number of people to be vaccinated this year	Number of people in the pop category to be vaccinated each Month (N/12)	
			$K/H \times 100$	$F \times L/100$	<b>(Based on the judgment of head of health facility)</b>		
1	Gituamba Health Center	150	14.1	161	161	14	
2	Gatukuyu Dispensary	419	39.5	452	452	38	
3	Mangu Catholic Health Center	250	23.6	270	270	23	
4	Dr. Mburu Clinic	142	13.4	153	153	13	
5	Salama Health Center	100	9.4	108	108	9	
<b>TOTAL</b>		1,061	100	1,144	1,144	96	

- Contribution by Gituamba Health Center =  $(150/1,061) \times 100 = 14.1\%$ . ( See figure 3.2 above)

Calculate the number of people in the population category to be vaccinated in the new-year in each health facility by **Multiplying the estimated number of people in the population category to be vaccinated in new-year in the division (column F) by Percent contribution of the health facility to the division's achievement last year (column L) and divide by 100. Fill column M**

### *Utopia Division Example:*

- **Gituamba Health Center =  $(1,144 \times 14.1)/100 = 161$ . ( See figure 3.2 above)**

Adjust the number of people in the population category to be vaccinated in each health facility in new-year

Having calculated the annual target for each health facility (based on percent contribution in previous year – Column M), the Head of each health facility should comment on his/her target by answering these questions

- Based on the population density and availability of other service delivery points in the communities from which the clients come to your health facility, is the target too low, too high or just okay?
- Is the target population assigned to your health facility realistic and achievable?

The target for each health facility should be adjusted as is necessary but the total targets for all the health facilities must not be less than the target already set for the division. It can be more than the original division target (column F). Fill column N.

### *Utopia Division Example*

- **For Gituamba Health Center, the target assigned is just okay. There is no need for adjustment. Column N = Column M = 161. ( figure 3.2 above)**

Calculate the number of people in the population category to be vaccinated each month in the new-year

Divide the adjusted annual target (column N) by 12

### *Utopia Division Example:*

- **Gituamba Health Center =  $161/12 = 14$ . ( figure 3.2 above)**

## **VACCINES FORECASTING**

In order to accurately estimate the vaccines, reliable data must be collected from the health facilities to the districts. Having set the target number of children to be vaccinated in the new-year,

each health facility should forecast the number of doses of vaccines required to reach all the target children and childbearing age women.

### **Advantages of obtaining accurate forecasting of vaccine needs**

1. It leads to efficient management of vaccines and immunization sessions
2. It eliminates shortages or overstocking of vaccines
3. It improves vaccine use and reduction of wastages
4. It helps to monitor the progress of immunization in relation to target coverage

There are three methods commonly used to estimate vaccine needs:

1. Target population
2. Previous consumption
3. Size of immunization sessions

All facilities are required to estimate vaccine needs using the target population method and if the Health facilities are sharing the same population, previous consumption method would be suitable.

### *Target Population Method*

Target population is the number of children under one year and women of childbearing age (15-49 years old).

To estimate vaccine needs on the basis of target population a number of parameter are necessary, which are:

- a. Target population
- b. Immunisation schedule
- c. Immunisation coverage target
- d. Wastage rate and wastage factor

## Target population

After target setting and have known the target to be covered in the Health facility for the year

## Immunisation schedule

Immunisation schedule determine the age limits and the number of doses required to be fully immunized among each target group (children under one and women of childbearing age).

**Table 3.1 Number of Doses for Each Vaccine**

Vaccines	Number of doses
BCG	1
Polio	4
Pentavalent	3
PCV	3
Measles	1
Yellow fever	1
Tetanus Toxoid for women of child bearing age (15-49 years)	5

## Immunization coverage target

The national policy is to reach every child. The Immunization coverage target for each antigen is depends on the health facility and district micro plans and work plans respectively. These plans indicate the attainable percentage coverage at the end of current year.

## Vaccine wastage rate and wastage factor

During immunization, the number of vaccine doses used is generally higher than the number of individuals immunized. The number of doses in excess represents “lost doses “or vaccine wastage. These may include:

- The remainder of doses discarded with vials after the immunization session
- Doses given outside the target
- Doses spoilt for one reason or the other e.g. VVM reached discard point, breakdown in the cold chain, frozen DTP+ HepB and TT or removed labels.
- Doses from vials broken during transport and handling
- Missing doses from vaccine stock ledgers etc

Number of unopened vaccines vials lost should be documented in the ledger books to facilitate calculations of wastage rate and factor.

Vaccine wastage can be explained into two ways:

- i. Wastage rate
- ii. Wastage factor

### *Vaccine wastage rate*

Vaccine wastage rate should be taken into account in the estimation of vaccine needs. Knowing the wastage rates helps to determine the wastage factor, which is one of the parameters used to estimate vaccine needs.

Vaccine wastage rates are not standard. Every district and health facility must calculate its monthly vaccine wastage rates of antigens and by the end of year know their vaccine wastages, which would be used for estimation of the vaccines.

Formula for Wastage rate (%)

$$\frac{\text{Doses Used} - \text{doses administered}}{\text{Doses used}} \times 100$$

Doses used include vaccines administered and wasted doses

Doses administered are doses which have been received by the targeted group.

### **Example on wastage rate**

Rioma health facility had 200 doses of BCG vaccine in the month of July 2005 and immunized 150 children under one year.

To calculate the vaccine wastage rate for Rioma health facility using the formula is as follows:

$$\frac{200 - 150}{200} \times 100 = \frac{50}{200} \times 100 = 25\%$$

### *Wastage Factor*

Vaccines Wastage Factor is a multiplier used to order vaccines to cater for the targeted population and wastage.

The total number of vaccines supplied within given period is referred to as 100% supply.

Formula for calculating wastage factor

$$\frac{100\% \text{ supply}}{(100\% \text{ supply} - \text{Wastage Rate})} = \text{Wastage Factor}$$

Using Rioma Health Facility example the wastage Factor is calculated as follows:

$$\frac{100}{(100 - 25)} = \frac{100}{75} = 1.33$$

In other terms, for every dose of a given antigen in the immunization schedule, we must anticipate 1.33 doses to take account of 25% wastage in the use of the vaccine.

### Calculating vaccine needs for a district and health facility

Using the above parameter the total annual vaccine doses are estimated by use of the following formula:

$$\text{Target Population} \times \text{Number of doses in the schedule} \times \text{Target coverage} \times \text{Wastage factor} \\ = \text{Total Annual doses i.e}$$

$$T_p \times N \text{ doses} \times T_c \times W_f = \text{Total Annual doses}$$

Note : Target coverage for the health facility level is 100% this is in line in reaching every child in the catchment area. Therefore the target coverage is 1

Example 1: (health facility to be formulated after target setting example to make it flow)

Rioma health facility in Eldorado district has a total population of 350,000 in 2005. The children under one year comprise 4% and women of childbearing age are 24% of the total population. The district vaccine manager was to forecast and order for all the routine vaccine. During the previous year the district immunized 10,000 children with BCG and had received 24,000 doses from the regional stores. The store had a balance of 4,000 doses of BCG at the end of the year 2004.

Using the Forecast Sheet (Annex xxx) the manager will forecast and order on after the calculation

Sequential calculations using the forecast sheet.

A. The target population is calculated as follows:

- Children under one year

$$4/100 \times 350,000 = 14,000$$

- Women of childbearing age

$$24/100 \times 350,000 = 84,000$$

B. Doses in immunization schedule for BCG is one dose

C. Wastage Factor for BCG from the example above of Rioma Health facility is 1.33

D. Total doses required for the district this year is calculated as follows:

Target population x immunization schedule x wastage factor = 14,000 x 1 x 1.33 = 18,620

## FORECASTING VACCINE NEEDS

**Table 3.2.1 Vaccines Forecast Sheet**

VACCINES FORECAST SHEET FOR YEAR \_\_\_\_\_ 2005 \_\_\_\_\_

LEVEL (Health facility/District) NAME: \_\_\_\_\_

RIOMA \_\_\_\_\_

	BCG	OPV	DPT+HEPB - HIB	MEASLES	TT
<b>1. ANNUAL NEEDS (DOSES)</b>					
<b>BASED ON TARGET POPULATION (ALL CHILDREN UNDER 12 MONTHS OF AGE; ALL CHILD BEARING AGE WOMEN)</b>					
[A] Target population	14,000	14,000	14,000	14,000	84,000
[B] Doses in immunization schedule	1	4	3	1	3
[C] Wastage factor	1.33				
[D] Total dose required this year = (A x B x C)	18,620				



**Table 3.2.2 Vaccines Forecast Sheet**

ANNEX 3: VACCINES FORCAST SHEET  
VACCINES FORECAST SHEET FOR YEAR \_\_\_\_\_

/EL (Health facility/District) NAME: _____	BCG	OPV	DPT-HEPB + HIB	MEASLES	TT
<b>. ANNUAL NEEDS (DOSES)</b>					
<i>BASED ON TARGET POPULATION (ALL CHILDREN UNDER 12 MONTHS OF AGE; ALL CHILD BEARING AGE WOMEN)</i>					
A] Target population					
B] Doses in immunization schedule					
C] Wastage factor					
D] Total dose required this year = (A x B x C)					
<b>. QUANTITY FOR SUPPLY PERIOD (DOSES)</b>					
<b>SUPPLY PERIODS: HEALTH FACILITY = 1 MONTH; DISTRICT STORE = 3 MONTHS</b>					
E] Supply period (months)					
F] Supply period (years) = (E/12)					
G] Total doses required for supply period = (D x F)					
<b>. MINIMUM STOCK (DOSES)</b>					
<i>ANY TIME YOUR STOCK REACH THIS LEVEL, YOU MUST REORDER IMMEDIATELY</i>					
H] Reserve stock proportion = (25%)					
I] Minimum or Reserve stock = (G x H)					
<b>. MAXIMUM STOCK (DOSES)</b>					
<i>YOUR STOCK CEILING, NEVER STOCK MORE THAN THIS AT ANY POINT IN TIME</i>					
J] Maximum stock = (G + I)					
<b>. QUANTITY TO BE ORDERED (DOSES)</b>					
<b>YOU MUST CALCULATE THIS EVERY TIME YOU WANT TO ORDER VACCINES</b>					
K] Quantity in stock at this time					
L] Quantity to order (doses) = (J - K)					

## 2. Estimating vaccine needs on the basis of previous consumption

The method of estimating vaccines needs based on previous vaccines consumption consists of calculating the quantity of vaccines consumed during the previous period. The resulting quantity is thereafter adjusted, for instance when there is increase in the population for the current period

by 10%.

This method is based on reliable stocks management data. It is suitable therefore for use in health facilities sharing the catchment area and where the stock management is good but there is insufficient information on immunisation objectives and targets for the implementation of the immunisation session.

The data required for estimating vaccines needs on the basis of previous consumption are:

- a. Number of children immunized previously
- b. Wastage factor for the specific antigen
- c. Immunization schedule for the antigen.

After calculating the total estimated doses an additional 10% of the total doses is added to cater for unexpected increase in population.

### Example

Kamweni Health center had immunized 60 children with BCG, the wastage Factor for BCG was 2, and immunization schedule for BCG is one dose. To calculate the vaccine requirement for the facility the following steps are taken:

Formula = number of children immunized x wastage factor x immunization schedule = number doses required in the period (one month) + 10% of the Number of doses = Total doses required for the month.

$$= 60 \times 2 \times 1 = 120$$

$$= 120 \times 10/100 = 12$$

Therefore:

Total vaccine requirement for the month is  $120+12 = 132$  to the nearest doses BCG vaccine which is 20 doses vial is 140 doses

This method may be difficult to apply for periods exceeding one year, but it is useful when making short-term orders. The method cannot take into consideration changes that may occur during the course of the planning period (e.g.: seasonal migrations, change of the number of target population during immunisation campaigns, etc.)

### Ads Syringes and needles and reconstitution needle and syringe estimation

AD syringes and needles = No of doses of antigen required.

Reconstruction syringes and needles

There two types of reconstitution needles and syringes

2 ml gauge .....

5 ml gauge .....

This should be estimated to be equal to number of vials containing antigen (different antigens have different dose vials from different manufacturers.)

## ORDERING VACCINES

Steps in ordering Vaccines

1. Defining vaccine supply period
2. Calculating quantities of vaccine for a supply period
3. Calculating minimum stock level
4. Calculating maximum stock level
5. Calculating total quantities of vaccine to be ordered

### Advantages of ordering vaccines

- a. Prevent vaccine stock outs and overstocking.
- b. Prevent expiry of vaccine during their storage period.
- c. Ensures that the other appropriate supplies are “bundled” e.i. Safety boxes, syringes and needles. This implies is that none of the components can be considered alone each component must be considered as part of a bundle that contains the other two. Bundling does not mean that the three items must be packaged together but should be supplied /brought together.

***Remember, long storage periods risk expiration of vaccines.***

### Defining vaccine supply period

After calculating the annual vaccine needs, taking into account the storage capacity and the period of time during which the vaccines will be stored at each specific level. Defining periods of vaccine supply depend on:

- The level operational (district, health facility)
- Status of the cold chain
- Storage space

For example, a health facility will have a shorter period of vaccines supply (one month) than the district store (three month), where the cold chain is more reliable.

**Table 3.3: Recommended standard periods for vaccines supply**

Location of the store	Supply period
Central store	Six months
Regional store	Six months
District store	Three month
Health facility	One month

Avoid overstocking vaccines as this may result in longer storage period which could lead to expiry vaccines

### ***Calculating quantities of vaccine for a supply period***

The needs for a specific storage or supply period can be calculated as follows:

$$\text{Vaccines needs for the period} = \frac{\text{Annual vaccines needs} \times \text{Supply period (in months)}}{\text{Number of months in year}}$$

Using the formula:

$$Q_{\text{period}} = (Q_{\text{year}}/12) \times P_{\text{supply}}$$

Where,

$$Q_{\text{period}} = \text{Vaccines needs for the period}$$

$$Q_{\text{year}} = \text{Annual vaccines needs}$$

$$P_{\text{supply}} = \text{Supply period (in months)}$$

12 represent the number of months in the year

### **Example: using Rioma Health Facility**

$$14,000 \times 1 \times 1.33 = 18,620 \text{ doses}$$

$$\text{District calculations} = 3/12 \times 18,620 = 4,655 \text{ doses}$$

Health facility calculations =  $1/12 \times 18,620 = 1,552$  doses

**TABLE 3.4: QUANTITY FOR SUPPLY PERIODS**

2. QUANTITY FOR SUPPLY PERIOD (DOSES)					
SUPPLY PERIODS: HEALTH FACILITY = 1 MONTH; DISTRICT STORE = 3 MONTHS					
[E] Supply period (months)	3				
[F] Supply period (years) = (E/12)	3/12				
[G] Total doses required for supply period = (D x F)	4,655				

### *Calculating minimum stock level*

The “minimum stock” represents the minimum number of vaccine doses that should be in the refrigerator on the arrival of the next supply consignment. The level of minimum stock is generally fixed at 25% of the total estimate of vaccines needs for a given supply period.

Using a formula

Minimum stock = Vaccines needs for the period X 25 %

$$S_{\text{mini}} = Q_{\text{period}} \times 25\% \text{ (or } 0.25)$$

**Note:** *the minimum stock takes into account the possible delays in supply as well as unexpected increase in the population to be immunised (untargeted population, migration, etc.).*

### **Example:**

$$4,655 \times 25/100 = 1,164$$

**Table 3.5: MINIMUM STOCK**

3. MINIMUM STOCK (DOSES)					
ANY TIME YOUR STOCK REACH THIS LEVEL, YOU MUST REORDER IMMEDIATELY					
[H] Reserve stock proportion = (25%)	0.25				
[I] Minimum or Reserve stock = (G x H)	1,164				

### *Calculating maximum stock level*

The maximum stock is the maximum number of vaccine doses that should be found in the refrigerator after a supply.

Using the formula:

Minimum stock = Vaccines needs for the period + Minimum stock

$$S_{\text{maxi}} = Q_{\text{period}} + S_{\text{mini}}$$

### Example

$$4,655 + 1,164 = 5,819 \text{ doses}$$

**TABLE 3.6: MAXIMUM STOCK**

4. MAXIMUM STOCK (DOSES) YOUR STOCK CEILING, NEVER STOCK MORE THAN THIS AT ANY POINT IN TIME					
[J] Maximum stock = (G + I)	5,819				

### *Calculating total quantities of vaccine to be ordered*

Once the order levels are determined, the vaccine quantities to be ordered are calculated on the basis of the balance in stock at hand and the maximum stock

The order may be based either on specific supply period (quarterly for districts and monthly for health facility) irrespective of the consumption. A stock shortage may occur before the end of the period. It is therefore recommended that an order be placed as soon as the stock of an antigen reaches the point where an order should be placed.

General formula:

Quantity to order = Maximum stock – stock at hand

$$Q_{\text{order}} = S_{\text{maxi}} - S_{\text{available}}$$

### Example xxx:

$$5,819 - 4,000 = 1,819 \text{ doses}$$

**TABLE 3.7: QUANTITY TO BE ORDERED**

5. QUANTITY TO BE ORDERED (DOSES) YOU MUST CALCULATE THIS EVERY TIME YOU WANT TO ORDER VACCINES					
[K] Quantity in stock at this time	4,000				
[L] Quantity to order (doses) = (J – K)	1,819				

## CONTROLLING VACCINE STOCKS

1. Receiving delivered vaccines and supplies
2. Storage, transport and handling of vaccines
3. Organizing vaccine distribution

#### 4. Inventory of vaccine stocks

The control of vaccines stocks is one of the main tasks of vaccines management. It consists of receiving and accepting vaccines, ensuring the required storing conditions and controlling the distribution of vaccines at all levels (national, regional, district and health facility) in order to ensure the quality of vaccines for immunization services.

##### *Receiving delivered vaccines and supplies*

Vaccines are ordered from the manufacturers once a year and delivered every 3 months. They are later distributed to the regional stores for the District vaccine manager to order for their respective health facilities.

**At the district stores:** The district vaccine store is usually situated at the district hospital. The staff at the district vaccine store main responsibility is to monitor the vaccines in the store, receives and issue them to the immunising health facilities in the district.

**At the Health facility:** The health facilities are delivered to vaccine from the district vaccine stores and in case of stock out at the facility they are supposed to collect the vaccines from the district. The following steps should be taken:

- When vaccines are provided with Vaccine Vial Monitors (VVM) the facility staff should check and record the VVM stage.
- If the VVM indicates that the vaccine has been excessively exposed to heat, VVM stage 3 and 4, the supplier and the supervisor must be alerted and such vaccines must not be used but rather put in the fridge awaiting the supervisor to collect them for eventual discarding. The number of doses exposed should be removed from the vaccine stock ledger and the information should be remarked as the vaccine discarded due to VVM change.
- Check the quantity and type of vaccines and other supplies mentioned in the S11 and must be signed.
- All stocks that have been accepted must be registered on the vaccine stock ledgers with the date of arrival, the number of doses batch /Lot number and the expiry date. If the expiry date is too close, the remaining stock must be thoroughly checked. **If the vaccine is not going to be used before its expiry date, the supervisor must be contacted and asked for a replacement and re - distribution.**
- After accepting delivery the vaccines should be arranged in the refrigerator according to their expiry dates following the rule of **FEFO: First to Expire - First Out** rule and their types from

the most heat sensitive to the least.

### All levels:

- Check for opened and/or damaged packaging, especially where syringes and needles are concerned
- Check and compare quantity on the S11 with the actual ones
- The S11 must be signed with all the inconsistencies recorded. All the noted inconsistencies must be brought to the attention of the supervisor and the supplier for replacement if necessary.

### Storage, transport and handling of vaccines

Vaccines are delicate biological products that *lose their effectiveness when they are exposed to incorrect temperatures*. Once vaccine effectiveness is lost through heat exposure, it is not possible to restore even if the vaccine is later stored at the required storage temperatures.

The following table illustrates the time limit of vaccine storage and the required storage temperatures.

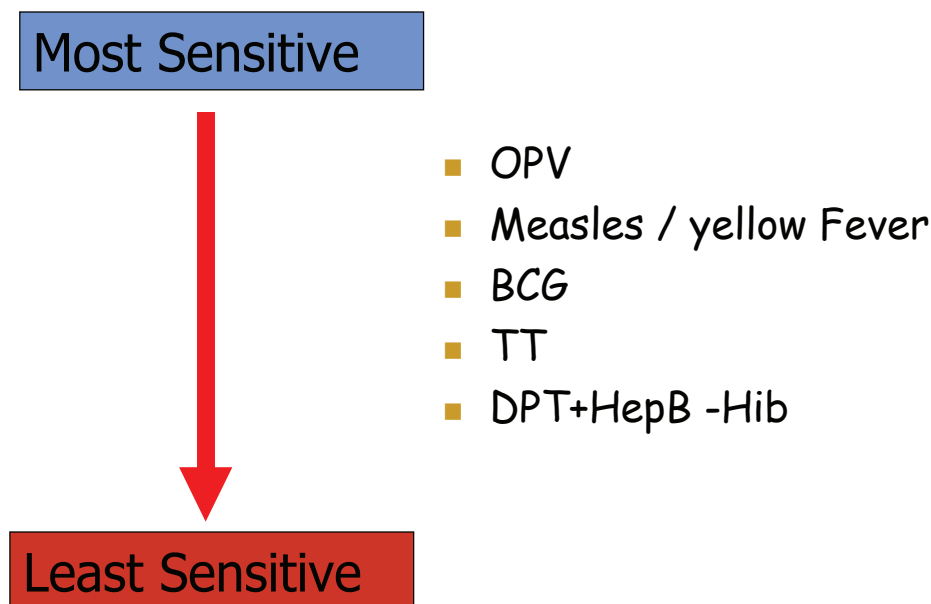

Figure 3.3: Limit of Vaccine Storage and the Required Storage Temperatures



## Vaccine storage conditions

Vaccines	National Up to 6 months, (Electricity)	Sub National Up to 3 months, (Electricity)	Peripheral Up to 1 month,
OPV YF	- 15° C to - 25° C		+ 2° C to + 8° C
Measles BCG	- 15° C to - 25° C or + 2° C to + 8° C		
DPT, DT, TT, Hep B, Hib DPT - Hep B, PCV	+ 2° C to + 8° C		
Diluent	Room Temperature		Room Temp. Cool to same temp as vaccines a day before use

**TT, liquid DPT+ Hepatitis B, PCV vaccines and diluents must NOT be frozen**

**Note:** The reliability of the cold chain decreases as the vaccines move from central to health facility. That is why it is recommended to keep small quantities of vaccines for very short periods down the system.

### Arranging vaccines in refrigerators

- Vaccines should be arranged in such a way as to facilitate air circulation and the reading of their identification and expiry date. Vaccines whose expiry date is closest must be used first (***First Expired, First out*** (FEFO) principle). Vaccines whose expiry dates have passed should not be preserved.
- Opened and partially used vials of vaccines that satisfy the Multi Dose Vial Policy requirements brought back from an immunization session should be marked arranged separately. To be used first in the next session.
- The refrigerator with vaccines should only be opened in case of necessity. Leaving the refrigerator open for too long must be avoided by all means.

The arrangement of vaccines in the refrigerator should follow the general storage guidelines given above for the District. The arrangement for Health facility should follow the sensitivity of the vaccines to heat.

## Preparing vaccines for transportation from District by Health Facility

Conditioned icepacks should be used to transport vaccines in the vaccine carrier. The vaccines should be arranged as follows:

- Vials with measles, YF, OPV and BCG vaccines are placed at the bottom.
- The DPT +HepB – Hib, PCV, TT vials and diluents will be placed at the top.
- Vaccines must always be accompanied by diluents from the same supplier

Diluents used are for different antigens (BCG, measles and yellow fever vaccines) and from different suppliers and they should not be interchanged because they made differently. Diluents should be stored next to their respective vaccines or placed in the refrigerator, the day before use, in order to cool them before reconstitution to avoid thermal shock to vaccines.

## Tools used in vaccine management

### *Vaccine Order Sheet*

**The Vaccine order sheet** is useful tool that helps in ensuring that the min /max stocking policy is adhered to by the Health facility when placing the orders for vaccines. It **should have the following:**

Minimum and maximum stock

- Number of children immunized
- Available stock
- Ordered vaccines

### **Issue Voucher (S 11)**

This is a government requisition form which should be issued in two copies. The original will be recorded and filed by the vaccine store manager. The copy will be for the facility serve as acknowledgement of receipt the vaccines and other supplies.

### **Vaccine stock ledgers**

The vaccine stock ledger is a vaccine management tool used in the store for recording vaccine movements to or from the refrigerator. They should be kept with the vaccines on the same premises. Every vaccine transaction should be recorded thus: received, issued and returned on individual row.

- The name of the antigen, Date of the operation, Destination (from /to), Quantities received
  - *Number of the batch*
  - *Expiry date of the batch*
- Balance in stock
- Remarks

### Vaccine physical stock taking

Vaccines physical stock taking means making a total count of quantities of vaccines in stock. The physical stock should cover all vaccines stores and should be carried out every month before ordering the supply.

- The stocks balance should be adjusted according to the physical stocks done.
- If the actual quantity is more than the theoretical stock, the difference should be recorded in the vaccine stock ledger and the remarks written as extra doses
- If the actual quantity is less than the theoretical stock, the difference should be recorded under as remarks written as missing doses.

## MONITORING THE USE OF VACCINES

- Interpreting vaccine monitoring indicators
- Multi-Dose Vial Policy (MDVP)
- Monitoring vaccine use and vaccine wastage

### *a. Interpreting vaccine monitoring indicators*

- The tools for monitoring vaccine exposure to high temperatures are:
  - Vaccine vial monitors (VVM)
  - 3M monitor

The tools for monitoring vaccine exposure to freezing are:

- Freeze watch – mainly in the regional and central vaccine stores
- Shake test

Figure 3.4: Vaccine Vial Monitors (VVM)

---

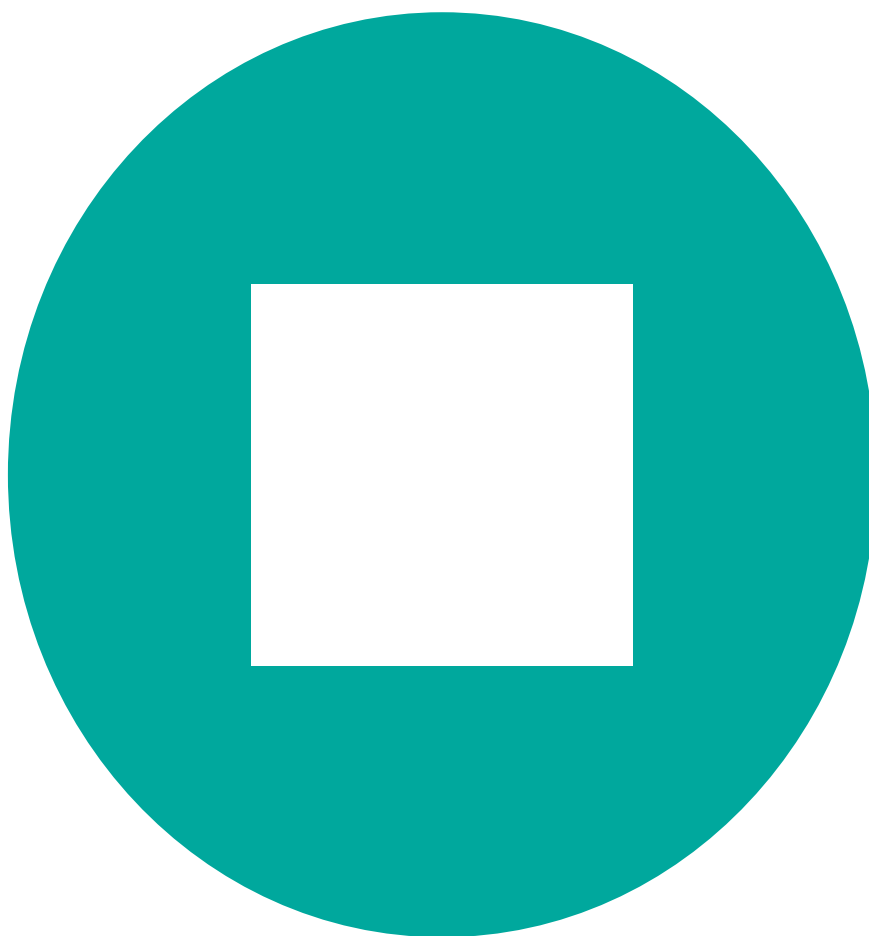

Vaccine vial monitor showing no heat exposure

A vaccine vial monitor (VVM) is a label with a heat-sensitive material, which is placed on a vaccine vial to register cumulative heat exposure over time. The **inner square** is made of heat sensitive material, which is a lighter colour than the outer circle at the starting point and **becomes darker** with exposure to heat.

The combined effects of time and temperature cause the monitor to change colour gradually and irreversibly. A direct relationship exists between the rate of colour change and temperature exposure. As the vial is exposed to more heat, the monitor changes colour more rapidly. After a sufficient amount of heat exposure has occurred, the colour of the monitor will signal that the vaccine in the vial has been exposed to too much heat and is no longer usable. In this case, the vial should be discarded.

Before opening a vial, the status of the VVM must be checked to see whether the vaccine has been damaged by heat.

Vials with VVMs in which the inner square has begun to darken but is still lighter than the outer circle should be used before the vials with a lighter inner square. In this way, health workers can minimize the number of vials that have to be rejected and this will decrease the wastage of vaccine.

Health workers can see at a glance when the vaccine has been exposed to high temperature. At the discard point, the inner square is the same as the outer circle. This reflects that the vial has been exposed to an unacceptable level and the vaccine potency reduced beyond acceptable limits.

The point to focus on is the colour of the inner square relative to the colour of the outer circle. It is important to use vaccine vial monitors because they help health workers determine whether vaccines have been spoiled by exposure to too much heat.

**Fig 3.5 Interpretation of The Vaccine Monitor**

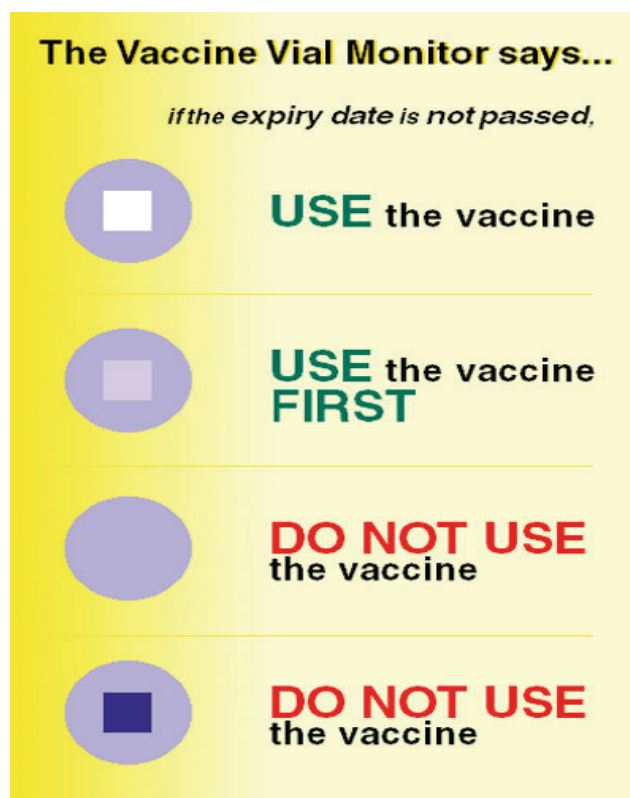

### **3M vaccine cold chain monitor card**

The monitor card must always be stored together with the vaccines through the cold chain system from the supplier to the central store, to the district stores, to the health centre. It detects cumulative heat exposure above 10°C and any exposure over 34°C. The explanation of what is required to be done is indicated on both sides of this card.

Fig 3.6 Vaccine Cold Chain Monitor Card

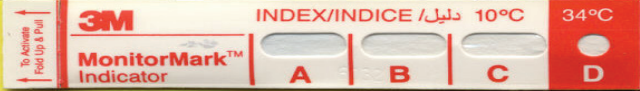
 <b>Vaccine Cold Chain Monitor</b>				
Date in	Index	Location	Date out	Index
		<b>INDEX/INDICE / دليل</b> 10°C    34°C		
		If A all blue	If B all blue	If C all blue
		Use within 3 months	Use within 3 months	Use within 3 months
		<b>TEST VACCINE BEFORE USE</b>		
		These vaccines may be used		
<b>SUPPLIER FOURNISSEUR</b>		Name: _____ Nom: _____ Date of dispatch: _____ Date d'expédition: _____ Vaccine: _____ Vaccin: _____		

The CCM monitors “the journey”, while the VVM monitors how “each passenger” has fared.

### The Freeze watch indicator

The freeze watch indicator tells you when the vaccine has been exposed to freezing temperatures. There two type of freeze watch indicators, one for the DPT+Hep B and another for Tetanus Toxoid vaccines.

The freeze watch indicator is a small vial containing blue (DPT+Hep B) or red (Tetanus Toxoid) alcohol which is trapped inside a plastic bulbous tube with a white paper background. When exposed to temperatures below 0°C for more than one hour, the vial bursts and releases the coloured liquid, staining the white paper background.

The freeze indicator is used to warn of freezing and is packed with vaccines that are sensitive to freezing temperatures, the vial breaks and releases a bright blue or red stain which spreads across the white paper background and the colour change cannot be reversed.

The figure below shows the indicator with an unbroken vial and a broken vial.

If the paper background of the indicator is stained blue or red, the shake test should be performed.

Fig 3.7 3M Freeze Watch



After freezing for over one hour, the indicator has burst out and has stained the background red. This shows that the temperature has been below 0°C.

## FRIDGE-TAG

This is a Data logger that shows daily minimum maximum temperatures over a period of 30 days and the current temperature in the fridge

Fig 3.8 Fridge Tag



## Shake test

This is a test used for testing suspected frozen vaccine vials. By shaking the vial it can be easily established whether vaccines TT, and DTP+Hep B are frozen or not. When any of these vaccines is suspected to be frozen, it is recommended to apply a shake test as follows:

- Take a vial you think may be frozen (Test sample)
- Select another vial of the same type of vaccine that you know has not been frozen (control sample)
- Hold in one hand and shake vigorously for 10-15 seconds
- Allow to stand and leave both vials to rest for 15-30 minutes
- Compare both vials against the light to see the sedimentation rate

## Results

If the test sample shows a much slower sedimentation rate same as the control sample, the test sample has not been frozen

If the sedimentation rate is faster and a thick sediment forms at the bottom of the vials, the test sample has been damaged by freezing the supervisor should be notified.

Fig 3.9 Shake Test

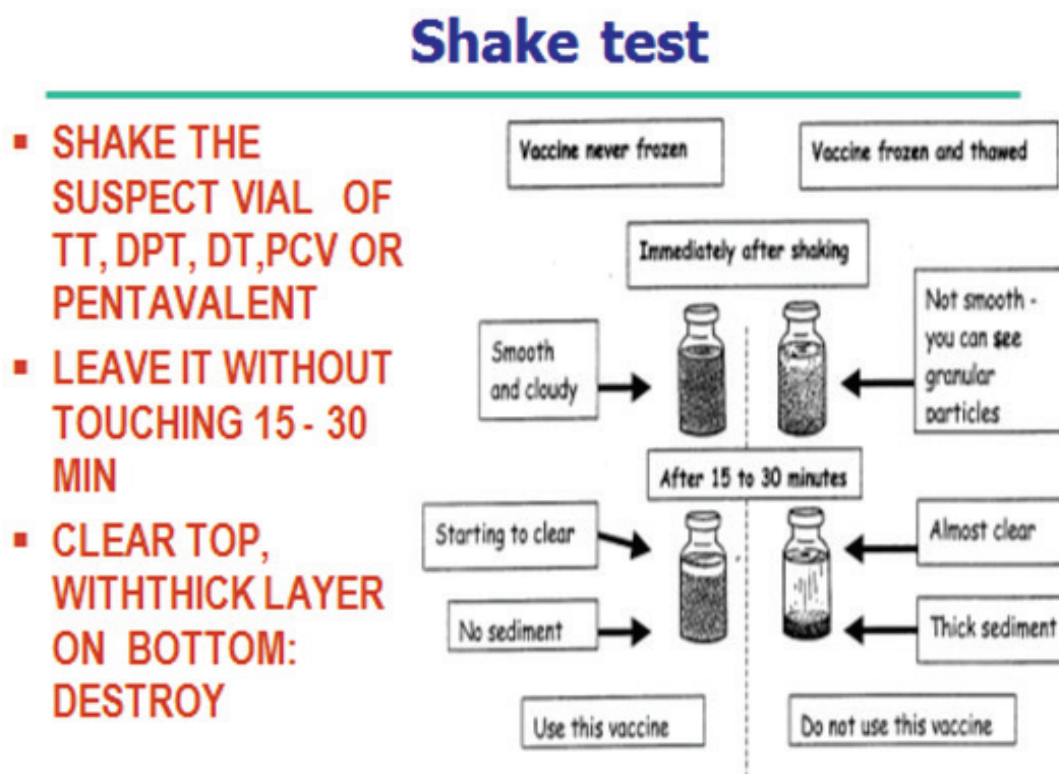



## Multi-Dose Vial Policy (MDVP)

An opened Multi-Dose Vial is a vial containing several doses of vaccine from which one or more doses have been taken.

Initially, any vial opened during an immunization session could be thrown away after the session, irrespective of the type of vaccine and the number of doses remaining.

To ensure the optimal use of vaccines, WHO and UNICEF issued directives authorizing the re-use, of opened multi-dose vials of some of the liquid vaccines such as polio, pentavalent, and TT. “Under certain conditions”,

Reconstituted vaccines (BCG, measles, yellow fever, Hib and liquid PCV10 are not included in these directives.

### What is Multi-Dose Vial Policy?

These new directives constitute what is called Multi-Dose Vial Policy (MDVP). This policy determines:

- i. Which of the opened vaccine vials may be preserved at the end of an immunization session and used the following days and
- ii. The conditions under which these vaccines may be stored and re-used without any risk.

The MDVP applies only to liquid vaccines (OPV, liquid pentavalent and TT).

In the case of freeze-dried vaccines, (BCG, measles, Hib and yellow fever) once they are reconstituted must be discarded after 6 hours or end of immunization session whichever comes first.

### WHO’s revised MDVP, on liquid Vaccine

The vaccine may be preserved and used for subsequent immunization session up to 4 weeks if all of the following conditions are met:

- The expiry date has not passed
- The vaccines are stored under appropriate cold chain conditions at all times
- The vaccine vial has not been submerged in water
- Sterile technique has been used to withdraw all doses and
- The VVM if attached has not reached the discard point.

## Important points

- The expiry date is the last day on which the vaccine may be used if preserved under the requisite conditions. Under no circumstance should an expired vaccine be used.
- Before applying the multi-dose vial policy, injection safety needs first to be improved by using auto-disable syringes (A-D) for all immunizations.
- This policy equally applies to all opened vials of vaccine to be used during outreach strategy or mass vaccination campaigns on conditions that standard procedures required for handling these vials are strictly followed.
- The direct impact of MDVP in the field may be a reduction in wastage for liquid vaccine.

## MONITORING THE VACCINE USE AND VACCINE WASTAGE

The monitoring of the use of vaccines will ensure the quality of immunization services and keep the vaccine wastage under control.

The goals of the monitoring are twofold:

1. To detect management problems and find appropriate solutions during the vaccine use
2. To contribute to the planning by providing data on vaccines needs and vaccines wastage rates

### Vaccine wastage

There are generally two complementary concept of the loss due to vaccine wastage:

#### Wasted doses

The wasted doses are those in unopened vials that have been lost before they could be administered for various reasons:

- Vaccines with expired date
- Damaged vaccines due to freezing
- Vaccine in vials with VVM at discard point or 3M indicator showing excess exposure to heat
- Doses that have been lost during the administration of vaccines due to lack of skill or knowledge of the vaccinator (overdose, multi-dose vials that are thrown away by either mistake or non-adherence to the multi-dose vial policy, etc.).

#### Sacrificed doses

The second notion of wastage is the **sacrifice** for a good cause. The sacrificed doses are the doses of vaccines that have been lost deliberately for the sake of the immunization to take place. Thus sacrificed vaccines are:

- The vials containing reconstituted vaccines that have been thrown away at the end of the immunization session in line with the MDVP
- The vaccines doses that have been administered to persons outside the target population

### **Vaccine monitoring indicators: vaccine wastage and use rates**

Vaccines management should endeavor to avoid vaccine losses and minimize sacrificed doses. This can be achieved only when the use of vaccines is efficiently monitored.

#### *Vaccines wastage rate*

This represents the quantity of vaccine taken out of the stocks, but not administered to the target population. It is the total amount of wasted and sacrificed doses.

Vaccine wastage rate refers to only one antigen. It does not cumulate for different antigens.

There are two types of vaccines wastage:

- Wastage of doses in unopened vials (wastage due to the system)
- Vaccine wastage of doses in opened vials incurred when administering vaccines

Differentiation between the various types of wastage rates allows the health worker to take appropriate corrective measures minimize loss of vaccines and increase the efficiency in immunization session.

The vaccine wastage rate is an indicator of the quality of immunization services. The calculation of wastage rates is based on vaccines stock management information which must be accurate and reliable.

#### *Wastage of doses in unopened vials (wastage due to the system)*

This wastage depends on the management, storage and handling conditions of vaccines.

The wastage caused by the system is the wastage of doses in **unopened vials**. The causes of such wastage can be due to any of the following:

- Failure of the cold chain: VVM reached discard point, frozen DTP or TT, etc.
- Poor handling: expired vaccines while in storage, vials without labels, missing as stated by the inventory, etc.
- Accidents: breakages, etc.

$$\text{Wastage (administered)} = \frac{\text{Used doses} - \text{Administered doses}}{\text{Used doses}} \times 100$$

**Note:**

1. *Used doses = Total quantity of doses contained in all the vials opened during the immunization. For each antigen, the quantity of used dose is equal to the sum of the products of number of vials and the number of doses in each vial*
2. *Administered doses = Doses which have been effectively administered to the target population. For BCG, OPV, DPT/HepB+Hib, Measles and Yellow Fever, the number of doses administered will be equal to the number of target children immunized. For TT, the number of administered doses is equal to the number of women in the target group immunized against TT*

### *Vaccine wastage of doses in opened vials incurred when administering vaccines*

This type of wastage depends on the conditions of use and quality of administering vaccines, including the skills of a health worker. It concerns vaccines in opened vials.

Wastages incurred while administering vaccines can be calculated as follows:

$$\text{Wastage (Systems)} = \frac{\text{Issued doses} - \text{Used doses}}{\text{Issued doses}} \times 100$$

**Note:**

1. *Issued doses = Total quantity of doses issued from the stock of vaccines for one reason or the other. For each antigen, the quantity of issued doses is equal to the difference between the available quantity of doses of vaccines and the quantity of doses of vaccines at the end of the period*
2. *Used doses = Total quantity of doses contained in all the vials opened during the immunization. For each antigen, the quantity of used dose is equal to the sum of the products of number of vials and the number of doses in each vial. This is reported as used doses by the districts on the “Monthly Vaccine Stock and Wastage Monitoring Report”*

## Overall wastage

The overall wastages rate is obtained from the following formula:

$$\text{Wastage (Overall)} = \frac{\text{Issued doses} - \text{Administered doses}}{\text{Issued doses}} \times 100$$

### **Note:**

1. *Issued doses = Total quantity of doses issued from the stock of vaccines for one reason or the other. For each antigen, the quantity of issued doses is equal to the difference between the available quantity of doses of vaccines and the quantity of doses of vaccines at the end of the period*
2. *Administered doses = Doses which have been effectively administered to the target population. For BCG, OPV, DPT/HepB+Hib, Measles and Yellow Fever, the number of doses administered will be equal to the number of target children immunized. For TT, the number of administered doses is equal to the number of women in the target group immunized against TT*

The overall wastage the sum of the wastage due to the system and wastage incurred when administering vaccines.

## Documenting vaccine wastage

All immunizing facilities should document their vaccine wastage per antigen. The tool for documenting vaccines wastage in each health facility is the monthly report section B of the EPI Immunization and Vitamin A Summary Sheet (MOH 710).

# COLD CHAIN

## Broad objectives

Update health workers on concept of cold chain.

## Specific objectives:

At the end of the session the health worker will be expected to:

1. Define the cold chain system.
2. List the cold chain equipment used in the country.
3. Demonstrate packing of vaccines in the cold chain equipment.
4. Describe basic principles of refrigeration.
5. Discuss equipment installation procedure.
6. Monitor cold chain temperature.
7. Carry out preventive maintenance activities.
8. Conduct basic fault finding procedure and remedial action.
9. Be able to order spare parts.
10. Be able to take equipment inventory.
11. Know common cold chain emergencies.

## DEFINITION

Cold chain is a process of maintaining vaccines in a potent state from the manufacturer to the recipient (child and woman of child bearing age). Vaccines lose their potency when exposed to high temperature, sunlight or freezing conditions depending on type.

Fig 4.2 Cold Chain System

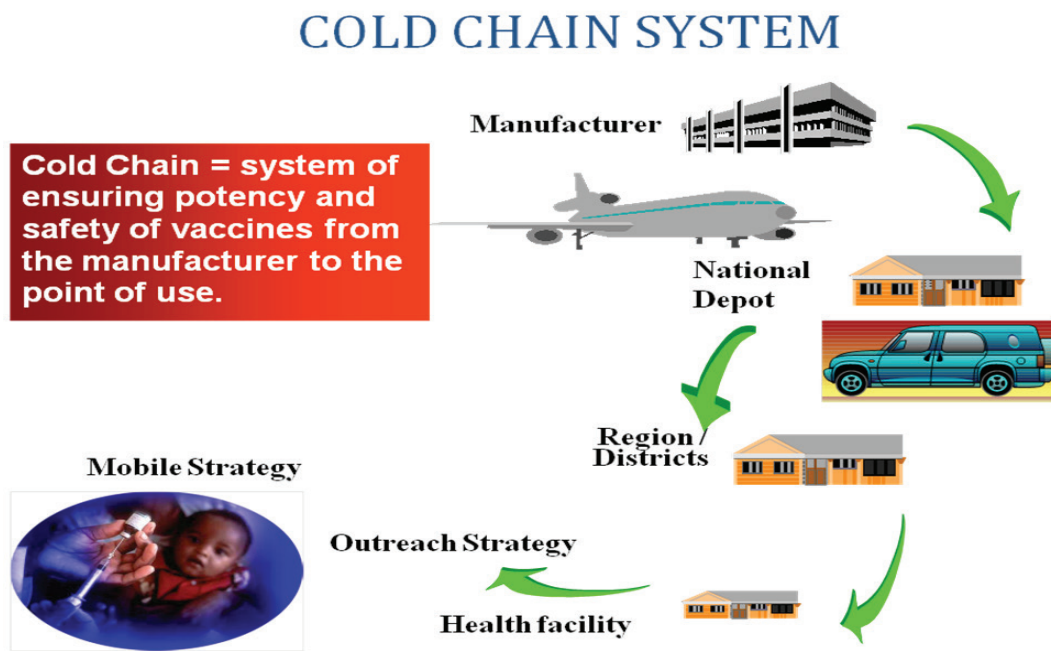
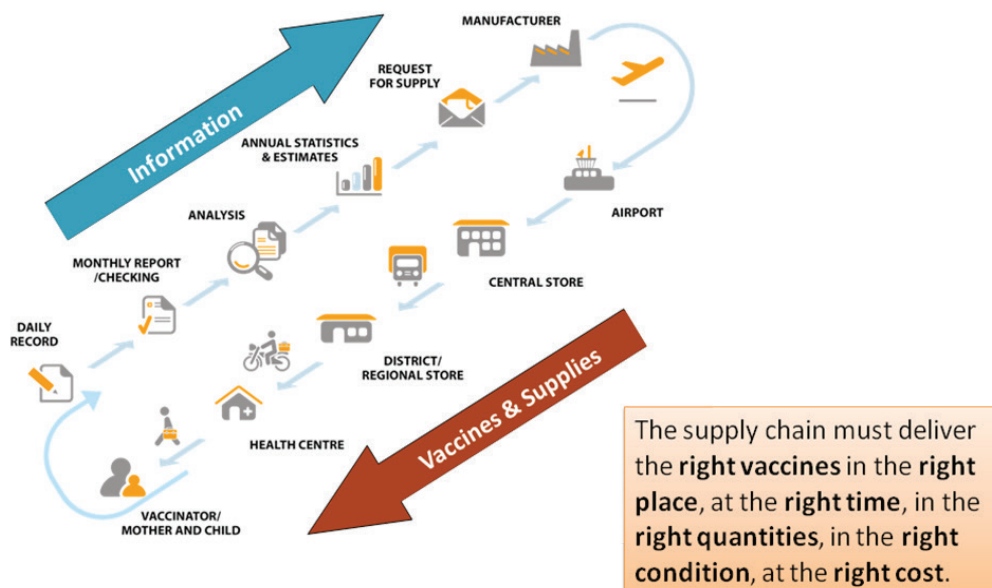

Figure 5.1 shows how supplies of vaccines travel in cold chain links from the manufacturer to the central vaccine store and eventually to the recipient through the regional and district vaccine depots and finally to the immunizing health facility.

An efficient cold chain system requires trained and skilled staff, reliable equipment and adherence to set standards.

Fig 4.2 Vaccine Delivery System

## Immunization Vaccine Delivery System



## COLD CHAIN EQUIPMENT

The equipment used in maintaining cold chain must meet standards set by WHO and UNICEF for safe vaccine storage. They vary depending on the level of use. Below is a list of the equipment currently used in Kenya.

1. Cold rooms and freezer rooms
2. Freezers and Ice-lined refrigerators
3. Gas electric refrigerators
4. Solar Refrigerators
5. Vaccine carriers
6. Cold boxes
7. Icepacks
8. Thermometers

### *Cold Rooms and Freezer Rooms*

These are large rooms, specially constructed for storage of large quantities of vaccines. They have two cooling units; one running while the other is standby, a 24-hour temperature monitoring system with an alarm, a recorder, and a backup generator that will turn on automatically when the regular power is interrupted. Cold rooms are found at the national and regional levels while freezer rooms are only found at the national level.

**Fig 4.3 The Cold/Freezer Room**

---





## *Freezers/ Ice-lined Refrigerators*

Freezers and ice-lined refrigerators are used at Central, Regional & District stores

### **Freezer**

**Figure 4.4 Freezer MF314**

---



Used for large storage of antigens and freezing of icepacks at the central, regional, district and sub district level.

### **Ice-lined refrigerator**

**Figure 4.5 Ice-lined refrigerator TCW3000AC**

---



Used for large storage of antigens at the district and sub district level. It can be converted into either a refrigerator or a freezer based on need.

Fig 4.6 Vaccine Storage Conditions

## Vaccine storage conditions

Certain vaccines are more at risk from loss of potency due:

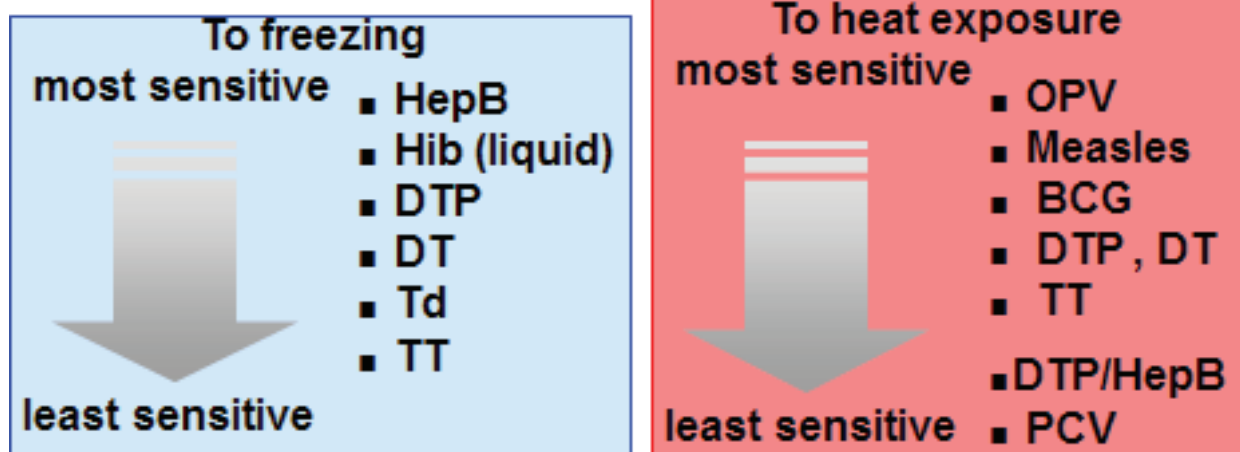

Freezing or heat exposure can totally and irreversibly damage the efficacy of these vaccines and increase the risk of side effects

### *Gas Electric refrigerators*

There are currently three major types of gas electric refrigerators used in the country; these are Sibir 170GE, RCW42EG and RCW50EG.

## Sibir170GE

Figure 4.7 Sibir V170GE



Vaccines are placed in shelves in order of sensitivity with the most sensitive to heat (OPV) being on the first shelf below the evaporator. TT and DPT+HepB –HiB being most sensitive to freezing are placed on the second last shelf from the bottom. Vaccines are packed leaving space of about 5cm in between the packets for air circulation.

The upper cabinet is used for freezing of icepacks.

This fridge is used at the district vaccine store and at the immunizing facilities with high target population.

Fig 4.8 packed upright refrigerator e.g. (Sibir 170 GE)

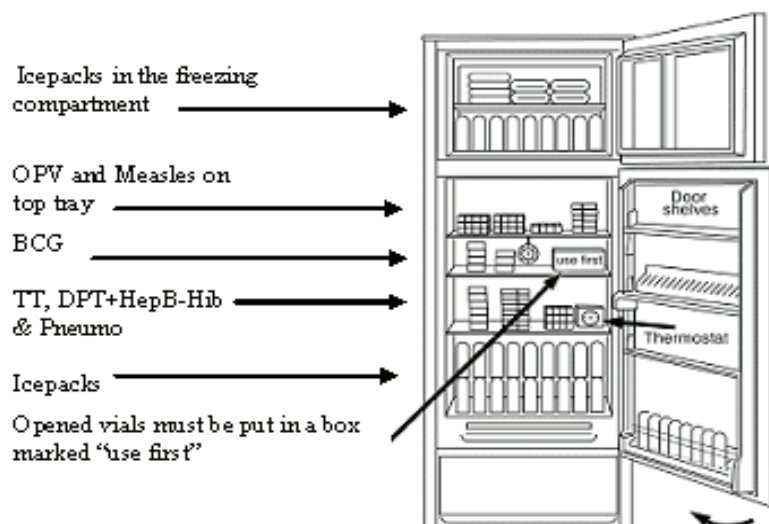

## RCW 42 EG

The refrigerator is designed for use at the service delivery point. It is operated either on electricity or gas and has top opening door. Trays of different colors are used to store each type of vaccine. The most sensitive to heat being oral polio vaccine is kept in blue tray that is placed at the bottom most part of the fridge while the most sensitive to freezing being DPT+HepB-HiB is kept in the red tray which is the top tray. A sticker is pasted on the front side of the refrigerator to guide on the vaccine arrangement and the arrangement order must be observed at all the times.

Figure 5.7 shows a picture of RCW 42 EG while figure 5.8 shows the arrangement of vaccines in the refrigerator.

**Fig 4.9 RCW42EG**



**Fig 4.10 Arrangement of Vaccines in RCW42EG**

Tray Colour	Position	Vaccine
Purple	Top	Pneumococcal
Red	Second	DPT+HepB-Hib
Orange	Third	Tetanus Toxoid
Yellow	Fourth	BCG
Green	Fifth	Measles / Yellow Fever
Blue	Bottom	Polio

## RCW 50 EG

This is similar to RCW42EG but has a double vaccine carrying capacity. It is suitable for use at places with higher target population or sub district depots. It also has higher fuel consumption.

**Fig 4.11 RCW50EG**

---



## Solar refrigerator

**Fig 4.12 Solar Refrigerator**

---

This is used in areas with high sun intensity. Sunrays are converted into electric energy, which is then used to supply the refrigerator.

Solar refrigerators are suitable for use at the service delivery points.

Arrangement of vaccines is similar to that of RCW.

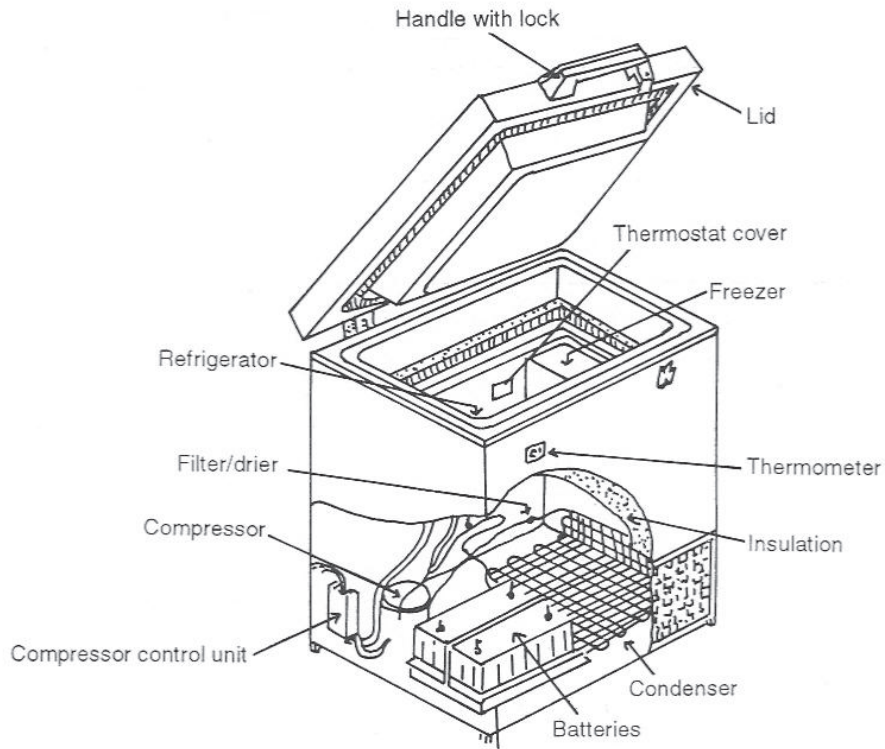

**Fig5.10 Solar refrigerator**

## Cold Box

Cold boxes are normally used for transportation of vaccines. They can also be used for temporary storage when a refrigerator breaks down. The cold life of a cold box varies depending on the type, the number of openings and the ambient temperature.

### *Packing ice packs in cold box*

**Fig 4.13 Packed Cold Box**



## Vaccine Carrier

Fig 4.14 Types of vaccine carriers

Vaccine carriers are used to transport vaccines from district stores to service delivery points (outreach / mobile) and during immunisation sessions. The cold life in a vaccine carrier is approximately 8 hours.



## Icepacks

Icepacks are flat rectangular plastic containers filled with water or gel. They are used in vaccine carriers, cold boxes or refrigerators to maintain temperatures. Always have at least an extra set of icepacks as a reserve while one set is in use.

## Thermometers

Different types of thermometers are used to monitor cold chain temperature. These are the dial and alcohol thermometers as shown below. They indicate the safe operating ranges of temperature of between  $+2^{\circ}\text{C}$  to  $+8^{\circ}\text{C}$  for refrigerators and  $-15^{\circ}\text{C}$  to  $-25^{\circ}\text{C}$  for freezers.

Fig 4.15 Thermometer

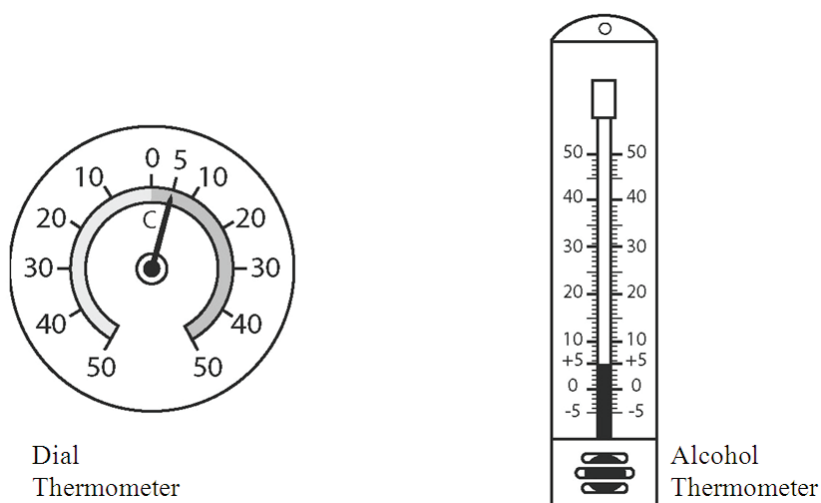

Dial  
Thermometer

Alcohol  
Thermometer

# BASIC PRINCIPLES OF REFRIGERATION

## Terminologies

- Refrigeration - The process of removing heat from an insulated space to maintain cold temperature.
- Refrigerator - This is an airtight equipment connected to a power source which can either be gas or electricity to achieve cooling.
- Refrigerant - A fluid with low boiling point which circulates in the refrigeration system to facilitate cooling.

## Types of refrigeration systems used in EPI

- Compression system
- Absorption system

**Compression type:** This type of refrigeration system uses a compressor, which when connected to electricity pumps the refrigerant through the pipes. The pipes connect the inside of the refrigerator to the outside. As the refrigerant circulates, it absorbs heat from inside lowering the temperature inside the refrigerator. The refrigerator hums when in operation. An example of this refrigerator is TCW 1152

**Absorption type:** This type of refrigerator has a heating unit, which uses either gas or electricity. When the heating unit is supplied with a source of heat the refrigerant boils, evaporates and circulates through the coiled pipes where it loses heat changing into liquid as it enters the pipe inside the refrigerator. Due to the low boiling properties of the refrigerant it evaporates again as it enters the inside pipes and this results into cooling. Absorption refrigerator is quiet when in operation. An example of absorption type of refrigerator is RCW 42 EG.

Figures 4.15 and 4.16 are showing the parts of absorption type refrigerator.



**Fig 4.15 Refrigerator Parts (front & inside)**

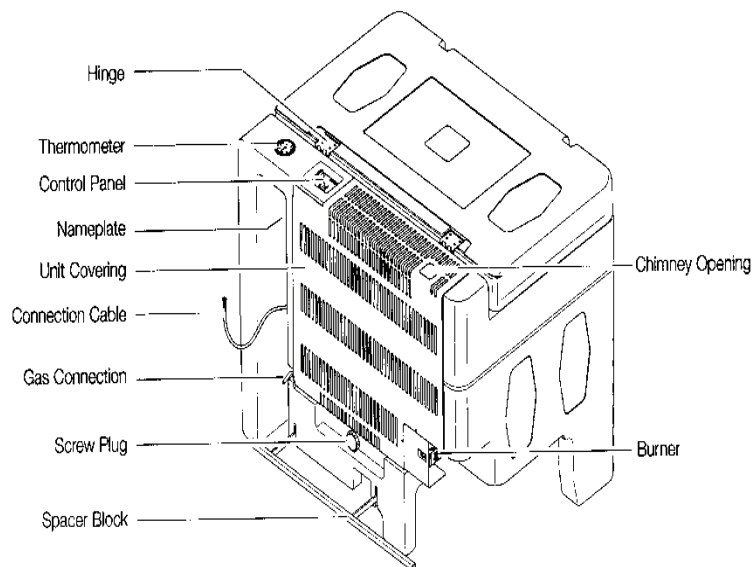
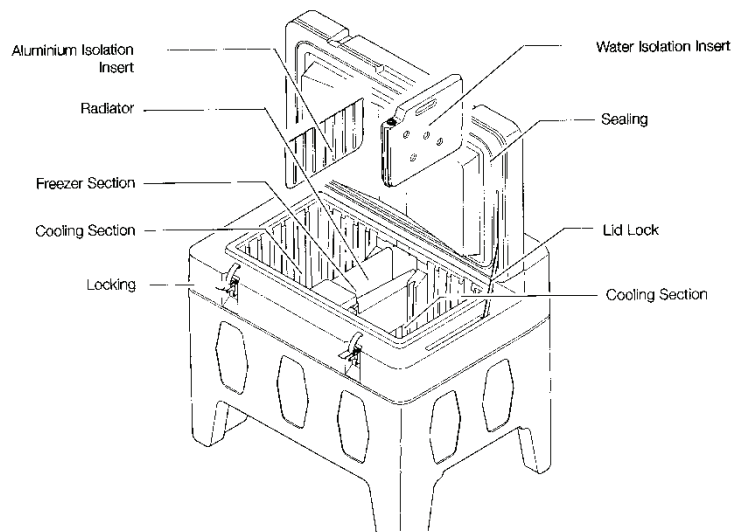

**Fig 4.16 Refrigerator Parts (back side)**

## HOW TO RECEIVE AND INSTALL (gas/electric refrigerator)

### *Action on receipt*

- Check the packaging case for damage. If there is damage, *notify the supplier before unpacking.*
- Unpack the refrigerator carefully.
- Check the refrigerator. If it is damaged, notify the supplier/District.
- Look for the manufacturer's instruction manual. This should be inside the packaging case or in the refrigerator.

- Read and follow the instructions given in the manual carefully.
- If the instructions are missing, use this book instead
- Check that the flue baffle is hanging inside the flue (fig 4.17).

**Fig 4.17**Checking flue baffle

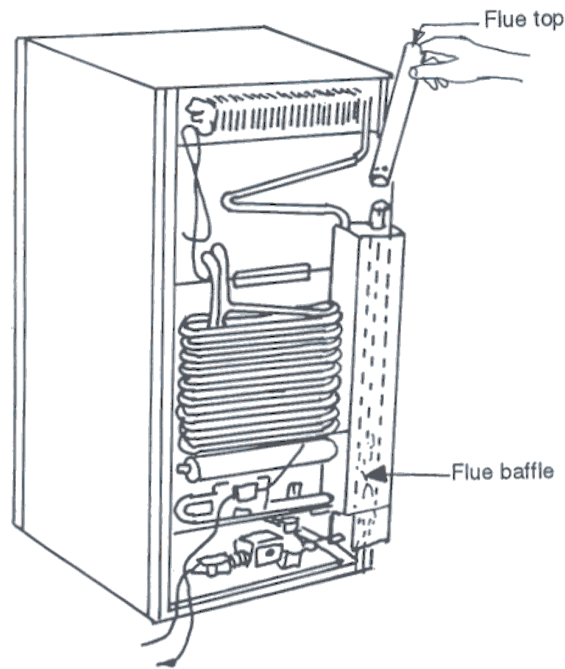

### *Installation*

1. Ensure the room is well ventilated.
2. Place the refrigerator in the coolest part of the building.
3. The refrigerator should be kept off draughts.
4. Minimum clearances to wall and roof must be at least 30cm and 40cm respectively as shown in figure 4.18.
5. Upright refrigerators should be placed on wooden blocks (25 to 50mm) thick to avoid dampness.
6. Ensure that the refrigerator is levelled well (fig4.19).

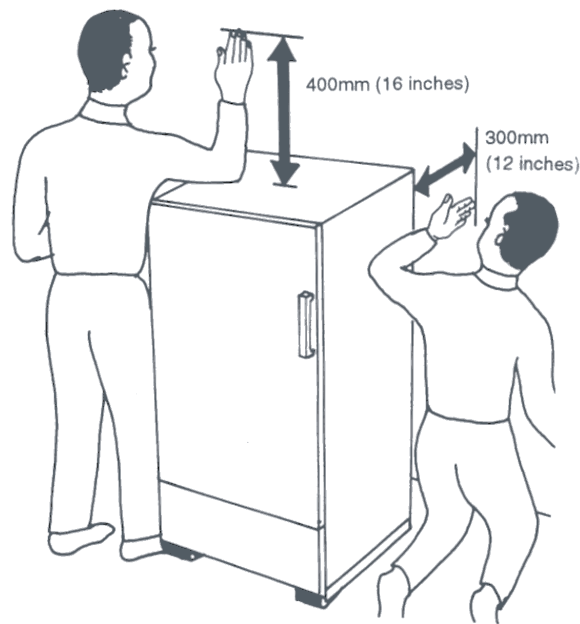

**Fig4.18 Refrigerator showing spacing for installation**

Refrigerator levelled	Refrigerator not levelled
Plumb line will be in line with refrigerator	Plumb line will not be in line with the refrigerator
No spill from a full saucer of water	A full saucer of water will spill when placed on top

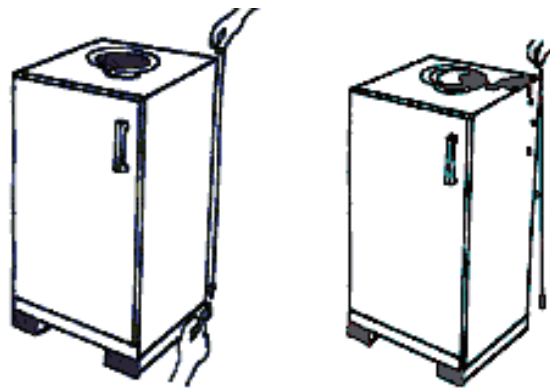

**Fig. 5.19 Checking levelling**

### *Lighting the gas refrigerator*

Instructions for lighting the gas refrigerator (in absence of the manufacturer's instructions).

- Make sure that there are no draughts from doors or windows. These will make it difficult to light the gas burner.
- Identify the control knobs and other parts for gas operation.

- Connect the gas cylinder to the refrigerator with the gas supply pipe. Check that the connections at each end of the pipe are tight.
- Open the valve on the gas cylinder and check for leaks at all gas connections using foam from soapy water.
- Turn the gas thermostat knob to medium position or position number (4)
- Open the gas valve by pushing the gas valve knob on the flame failure device as far down as possible and keep it pushed in.
- Push the igniter button to light the gas. Look through the sight glass/window to see the flame.
- If the gas does not light, push the igniter button again. Repeat, if necessary until you can see the flame.
- After you see the flame, keep the flame failure device button pushed in for at least 15 seconds, and then release it.
- Check that the flame stays lit. If it goes out, repeat the lighting procedure.

**Note:** When lighting for the first time, or after replacing the gas cylinder, the flame may go out easily. This is because of air in the gas supply tube.

### *Adjusting the temperature, ensure a 48hr observation period*

- After checking the inside temperature, the control knob can be turned towards a warmer or colder position if necessary.
- The control knob is usually marked “1” to “7”, “MIN”, “MED” and “MAX” or with an arrow indicating how to turn to colder temperature as shown in fig 5.17.
- No. “1” or “MIN” gives the warmest and No. “7” or “MAX” gives the coldest temperature.



**Fig. 4.20** Types of control knobs

## MONITORING COLD CHAIN TEMPERATURE

### *How to use the cold chain temperature-monitoring chart*

Read and record the refrigerator temperature twice daily, morning and evening including weekends and public holidays. Carefully record these temperature readings on the cold chain-recording sheet.

You must enter:

- Name and type of refrigerator
- Name of the district
- Name of the health institution
- Power Source (Normally operating on)
- The date
- The number of icepacks frozen today
- The number of icepacks used today
- The number of hours of electricity failure
- Shortage of gas (Mark with X)
- Gas cylinder renewed (Mark with X)
- Plot the temperature morning and evening
- Report on faults and problems at the bottom off the chart
- Note that the bold line is for start of the day which is mid night and the broken line mid day. Charting should therefore be done at the centre of the bold and dotted line in the morning, and at the centre of the broken and bold line for the evening charting as shown on figure 4.21.

## temperature Chart

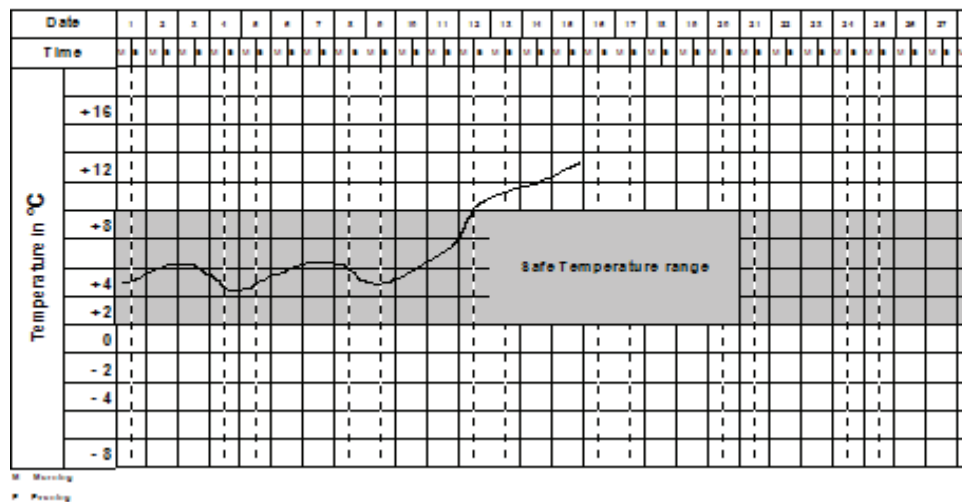

Fig 4.21 Charting temperature-monitoring chart for refrigerators.

## PREVENTIVE MAINTENANCE ACTIVITIES

### *Daily activities*

- Check temperature twice, in the morning and evening including public holidays and weekends and chart on the temperature-monitoring chart. Ensure the temperature is between +2°C to +8°C.
- Check that the refrigerator is operating and the burner flame is blue for gas refrigerator.
- Make sure that there is enough gas in the cylinder. Health worker should know how long a cylinder takes when running continuously.
- Ensure that vaccines are well arranged in the refrigerator
- **DO NOT** keep any other item in refrigerator apart from vaccines and diluents.
- Keep a spare gas cylinder available and always replace the gas cylinder before it is completely empty.

### *Weekly activity*

- Check the ice formation on the evaporator. If the ice is thicker than 6mm to 10mm defrost the refrigerator.
- Check that the refrigerator is level.

### *Monthly activity*

- Check that the condenser and cooling unit are clean. Remove any dirt or dust with a soft brush or cloth.

- When necessary, clean inside and outside of the refrigerator with a damp cloth.
- Clean door gasket and powder it with perfume free talcum.
- Check the gas connections for leaks
- In solar refrigerator
  - *Gently wash the panels with plenty of water and soft cloth (avoid use of detergents)*
  - *Check battery acid level and top up with distilled water when necessary.*
  - *Check battery terminal for tightness and corrosion. Lubricate with battery terminal jelly or petroleum jelly.*

### *Yearly activity – by the medical engineering technician*

- Clean the gas burner and gas jet
- Clean the flue and baffle

## **WHAT TO DO IF THE REFRIGERATOR IS NOT WORKING PROPERLY**

The refrigerator is not working properly if any of the following happens:

- The refrigerator is not cooling at all
- The refrigerator is not cold enough above 8 degrees centigrade
- The refrigerator is too cold below 2 degrees centigrade

### ***Follow these instructions when using the fault finding flow chart fig 4.19***

Ensure that Vaccines are transferred into a vaccine carrier or cold box before determining the fault.

- Always start with the first possible fault as shown on the flow diagram.
- Make sure that a fault does not exist before going on to the next one.
- If, after checking all the possible faults, the refrigerator is still not working properly, start at the beginning and check everything again.
- If, after checking all the possible faults twice, the refrigerator is not working properly, ***refer to the district for further action by a trained technician***

### ***Checking the door sealing***

- Place a thin paper (foolscap) strip in between the door and body of refrigerator
- Close the door.

- Pull the paper strip (Foolscap), if it moves easily or falls by itself, the door gasket is faulty, or the door hinges are loose or broken. Take necessary action and if unable, refer for further action by a skilled technician.

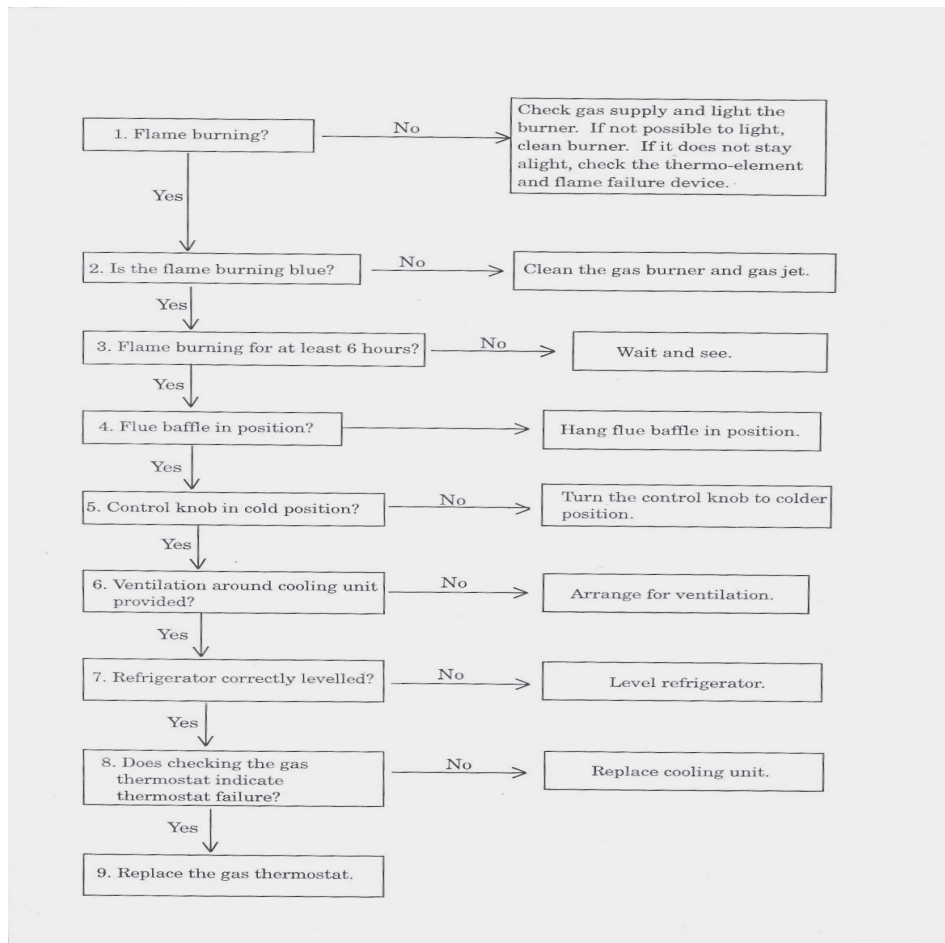

**Fig 4.22 Refrigerator not working at all**

### *Checking gas supply*

- Always keep a spare gas supply tube.
- Use soapy water to check for any gas leakage
- If there is a leakage in the gas supply tube, replace it.
- Does not use the refrigerator on gas operation if there is leaking connections, which you cannot repair, refer to the district for further action by a skilled technician.

### *Checking the gas thermostat*

- Remove the capillary tube end from the evaporator.
- Put the capillary tube end into a glass of ice cubes.



- Turn the thermostat control knob to “maximum” position.
- Watch the flame in the sight glass and slowly turn the thermostat control knob towards the “minimum” position. If the flame gets smaller, the thermostat is working. If the flame does not get smaller, the thermostat is faulty. Replace the thermostat.

### *Checking the thermo-element*

- Check that the nut “A” between the thermo- element and the flame failure device is tight.
- Check that the tip “B” of the thermo-element goes into the flame 3 to 4 mm (3/16 inch). If it does not, loosen the fastening “C” and adjust the position of the tip of the thermo-element.
- Check the flame failure device.

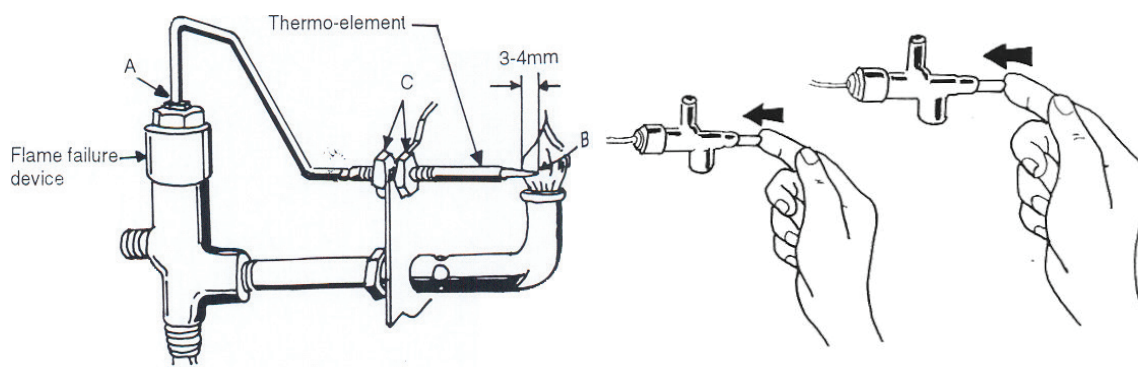

**Fig. 4.23 Flame failure device.**

### *Checking the flame failure device*

- Press the flame failure device button as far in as possible.
- Light the burner and wait for 15 to 20 seconds.
- Release the button and check the thermo-element. If the flame is accidentally blown out, the flame failure device must shut off the gas supply within one minute.
- Blow out the flame. Wait for one minute.
- Try to light the burner without pressing the flame failure device button.
- If the burner lights, the flame failure device is faulty. Replace it.

### *Defrosting*

It is quite normal for ice and frost to form on the evaporator. A thin layer of frost does not affect the cooling performance but if the frost grows thick approximately (6 to 10m (1/4 –3/8”) or more), it must be removed by defrosting.

### *Defrosting Procedure*

- Move the vaccine into another refrigerator or store it in a cold box with icepacks
- Turn off the gas supply (or remove plug from the wall socket if on electric operation).
- Open the door of the refrigerator and leave it open for the ice to melt normally or use warm water with a cloth to thaw the ice
- Do not use knives or other sharp instruments.
- Wipe the freezer compartment dry.
- Clean and dry the refrigerator.
- Light the burner (or plug in three pin top plug into the wall socket if on electric operation).
- Wait until the temperature stabilises between +2°C to +8°C.
- Place the vaccine inside and close the door.

### *Cleaning the flue and baffle*

- Turn off the gas supply
- Remove the burner protection plate.
- Cover the burner with a piece of clean cloth, to protect it and to collect the dirt.
- Remove the flue top. Take the flue baffle out of the flue.

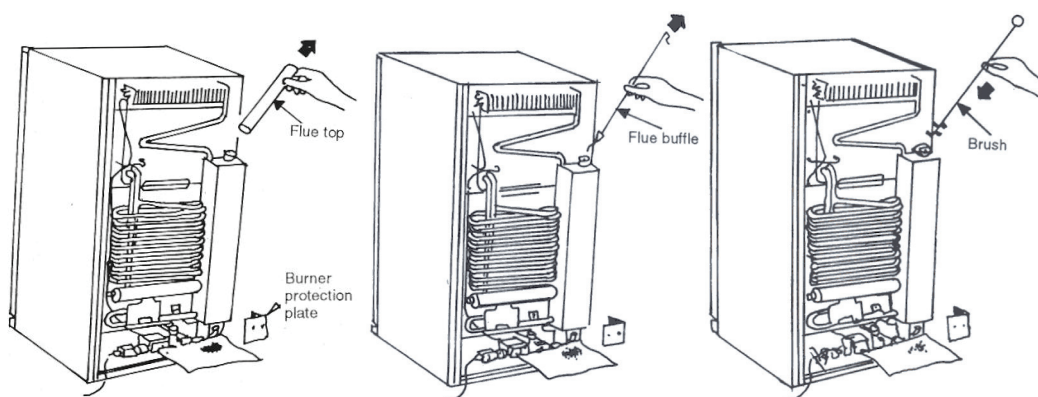

**Fig 5.24** Cleaning the flue and baffle

### *Cleaning the refrigerator*

- Always clean the inside of the refrigerator when defrosting.
- Use warm water and soap.
- Never use scouring powder, steel wool or abrasive cleaners on any refrigerator with a metallic surface paint.

- Clean the door gasket and put some talcum on it.
- Wipe all parts dry before starting the refrigerator.
- Clean the outside with a soft brush or a piece of cloth.
- Clean the condenser and cooling unit with soft brush.
- Light the burner (connect the power plug into the wall socket if on electric operation).
- Wait until the temperature stabilizes between +2°C to +8°C to return vaccines.

### *Cleaning the gas burner and gas jet*

There are different types of burner units. You should use the manufacturer's instructions for your refrigerator. If the instructions are missing, ask the district for a new copy.

- Transfer the vaccines into a vaccine carrier or cold box.
- Turn off the gas supply.
- Remove the cover plate(s) if any, which protect the burner and jet.
- Remove the gas jet. This is located on the gas inlet side of the burner.
- Wash the gas jet carefully in alcohol, kerosene or petrol. Blow through it to dry (Do not use any sharp object to clear the jet).
- Check that the jet is completely clear by looking through it against the light.
- If the jet is damaged or badly blocked that cannot be cleared, fit a new one.
- Clean the gas burner with a soft brush and blow it free of dust.
- Replace the parts and Check for leaks.
- Light the burner and wait until the temperature inside has come down to +2°C to +8°C before replacing the vaccine.

### **Replacing the door gasket for RCW 42 EG**

1. Check that the size of the replacement gasket is correct.
2. Pull out the old gasket carefully.
3. Clean the groove with a wet cloth or gauze.
4. Press in the replacement gasket into the groove, and ensure that the gasket has not left any gap.

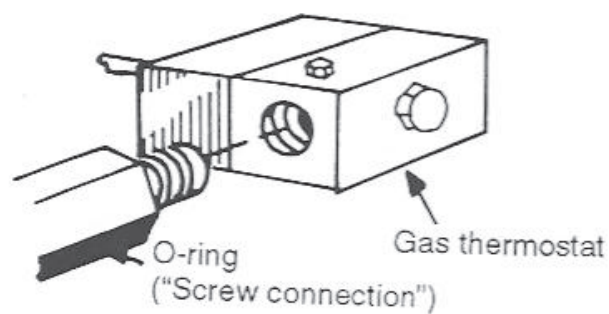

**Fig. 4.25 Replacing door gasket**

## Replacing the gas thermostat

To replace the gas thermostat, the main steps are as follows:

1. Turn off the gas supply.
2. Remove the capillary tube end from the evaporator and carefully pull it out of the rear of the refrigerator cabinet.
3. Disconnect other gas equipment parts from the thermostat. Two different types of connection between the gas thermostat and gas pipe are shown below.



**Fig. 4.26 Gas thermostat**

4. Connect the new thermostat.
5. Fasten the capillary tube end to the evaporator.

Note: Be very careful not to break the capillary tube. Make sure that the capillary tube makes contact with the evaporator only where it is to be fastened.

6. Check for leaks before lighting the burner.

## Replacing the flame failure device (safety valve) and thermo-element

There are different types of flame failure device. You should use the manufacturer's instructions for your refrigerator.

To replace the flame failure device, the main steps to be followed are:

1. Turn off the gas supply.
2. Unscrew the thermo-element nut and remove the thermo-element from the flame failure device.
3. Disconnect the gas thermostat, gas pipe and any other parts from the flame failure device.

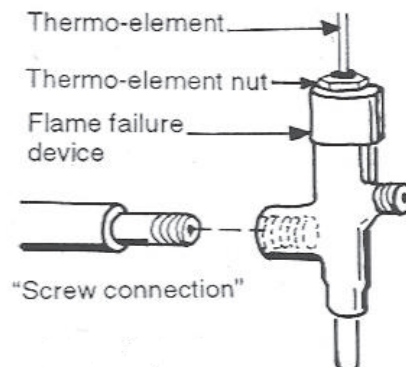

**Fig 4.27 Flame failure device connections**

1. If the thermo-element must also be replaced, disconnect the other end of the thermo-element from the gas burner unit. Connect the new thermo-element to the gas burner unit. Adjust the tip correctly.
2. Connect the thermo-element to the flame failure device, and tighten the nut fully.
3. Check for leaks before lighting the burner.

## Starting on electric operation

- If the refrigerator has been on gas operation, take the following action:

- Turn off the gas supply at the gas cylinder.
- Wait until the burner flame goes out.
- Disconnect the gas supply regulator from the gas cylinder.
- Check that the power supply voltage is correct (220V – 240V).
- Plug in the top plug into the wall socket.
- Turn the thermometer control knob to medium or position 4, put a thermometer in the fridge and leave the refrigerator running for 3 to 4 hours. If it does not start, ensure that the plug is wired correctly.
- Read the temperature inside the refrigerator. It *must be* between +2°C to +8 °C.

## Adjusting the temperature

After confirming that the refrigerator is working on electricity, it is important to check the temperature because the temperature setting for gas operation may give very low temperature for electric operation. Monitor the refrigerator and adjust the thermostat control knob accordingly depending on the temperatures inside the refrigerator. The temperature must stabilise between (+2°C to +8 °C).

If the refrigerator does not cool, follow the instructions shown in fig 4.28

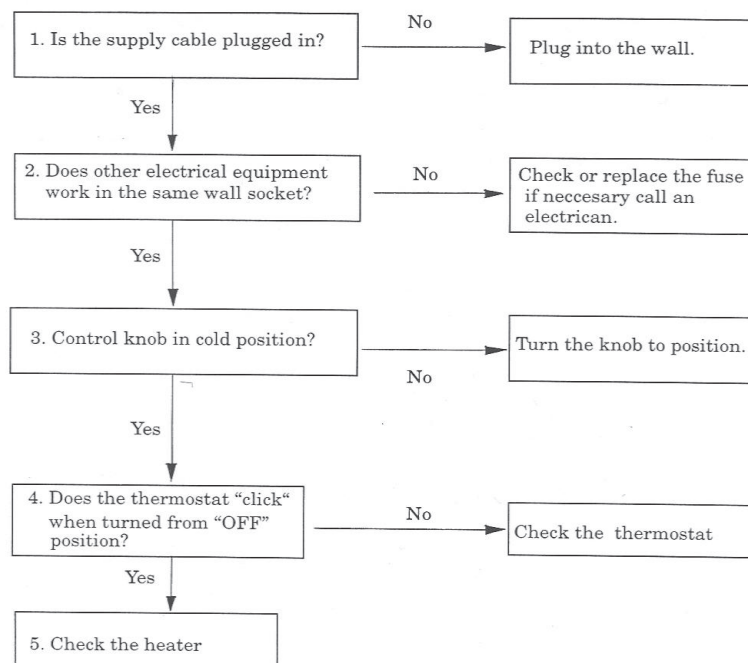

**Fig 4.28 Refrigerator not cooling at all on (electrical operation)**

## Replacing the three pin top plug

The standard plug is the square three pin 13 Amp. top plug shown below. Figure 5.29

Equipment come with different type of plugs when imported, but all plugs that do not correspond to the three pin top plug must be replaced to the ones shown.



**Fig 4.29 Three pin top plug**

The correct colour codes must be observed when doing the wiring.

- Red or Brown wires are for LIVE wire
- Black or Blue wires are for NEUTRAL wire
- Yellow/Green or Green wire for EARTH wire

The top plug normally has markings on the pins corresponding to the wires as shown.

- E for Earth
- N for Neutral
- L for Live

When making connections the correct colour code of wires must correspond with the pins. Failure to do so will result into short-circuit.

## ORDERING SPARE PARTS

a) When ordering spare parts, always state:

- Manufacturer and model or type (shown on the data plate on the fridge)
- Voltage and wattage (if electric parts are ordered)

- Serial number (**shown on the data plate**)
- Spare parts description (use the names given in this manual)

b) Location of a data plate varies from model to model. Usually it is located on the rear, on the lower door or on the walls inside the refrigerator. In some other brands, the data plate may be found behind the bottom drawer.

c) Always keep in stock

- One spare full gas cylinder.
- One spare gas supply pipe.
- One spare heater (for electric operation).
- Spare fuses or fuse wire for electric operation).

## EQUIPMENT INVENTORY

It is important to keep records of equipments. A good equipment inventory will provide the information needed to track the location, maintenance schedule, replacement and evaluation of the adequacy of the equipment. Records for each piece of equipment should include:

- Technical information (brand, model, serial number, date of entry into service and date of final removal from service)
- Specific location
- Current condition (working, in repair, un-repairable)

## COLD CHAIN EMERGENCIES

Emergencies can interrupt immunisation services if not planned for. Some of the common cold chain emergencies include:

- Equipment breakdown.
- Electric power failure.
- Shortage of gas.
- Shortage of spare parts.

There should be a warning system for identifying equipment failure and make arrangements in advance for moving vaccines to the nearest health facility or location that has appropriate substitute equipment.



The district should be notified as soon as possible of such failure.

*Caution*

- Use only one power source
- Emergency plan
- Transferred vaccines need to be captured in the ledger books

# HOW TO ORGANIZE IMMUNIZATION IN THE HEALTH FACILITIES AND MOBILE/OUTREACH CLINICS

## CHAPTER

# 5

This Chapter will describe how to organize your immunization activities at static and outreach/mobile posts to ensure quality sessions.

### Learning objectives

At the end of this chapter you will be able to:

1. Arrange the waiting area
2. Organize the flow of patients/clients
3. Describe the process that takes place in the registration desk
4. List and explain the important tasks in MCH clinic
5. Organize for outreach and mobile health service.

### Introduction

Immunization sessions must be arranged so that clients who attend for the first time will return for the subsequent doses. The session should be arranged and organized in such a way that they are convenient and comfortable for the parents /guardians.

For this to be realized, make sure that logistics required are available and the environment safe and comfortable for the parents/guardians.

The preparations include:

- Making sure that vaccines, supplies, and equipments are available
- Arranging space for the convenience and comfort of health workers and parent/guardian.

## ARRANGEMENT OF SPACE FOR IMMUNIZATION

The arrangement of space in your health facility will affect how you perform your work and the time taken by parent/guardian to during the immunization process. The space that you set up for immunizations should be:

- In a clean area not directly exposed to the sunlight, rain or drought
- Convenient for Health Worker who is preparing vaccines and immunizing
- Easily accessible to parent/guardian, but arranged in such way that it is not crowding around the immunization station
- Quiet enough for health workers to be able to explain what he or she is doing and give advice

## ORGANIZING PATIENT/CLIENT FLOW

Whether your site is inside or outside a building, the rules for organizing parent's / guardian's flow still remain the same.

- Immunization is one of the activities of the MCH clinic, so it should be integrated with the other services for good patient / guardian flow.
- For smooth floor two doors are ideal, one for entry and the other for the exit. However where a room does not have two doors, the staff should discuss and decide how best they can improve.
- Guide the parent / guardian into a single queue to enter the MCH area. Ensure a first-come-first served system.
- As far as possible try to see one parent/ guardian at a time.
- Children who are very sick should be identified and attended to first.
- When the parents /guardians are through at MCH clinic thank him/ her for coming.

The Health facility should have:

- Waiting area where parents and guardian can sit before being immunized as they receive health talks; as the talks will be better received if people are comfortably seated in the waiting bay.
- Space and equipments for screening, registration, recording and immunizing.
- A table for vaccines and injection equipments.
- Two chairs/stools; one for the parent or guardian, one for the health worker.

If you provide other services during immunization you need space and equipments for them as well. *Set up separate station for each of these services, which include.*

- An area for health education
- Weighing babies and recording their growth
- Treatment
- Antenatal care
- If there are many parents/guardians waiting, sitting arrangements should in away that will ensure that parents/guardians maintain their place in the queue

## THE REGISTRATION DESK

This is where you register and direct all parent's/guardian's to the other stations within the health facility according to their needs and serves as the waiting area for clients requiring MCH services **i.e.**

- Children under five years old,
- Expectant women,
- Women for family planning services.

Greet the mothers in a friendly way. For new parent's/guardian's, give them appropriate cards and fill in personal information. For re-attendants, tick in the appropriate registers.

## THE ACTIVITIES OF THE MCH CLINIC

The important tasks in the MCH clinics include the following:

### *i) Health Promotion*

Health education to individuals and groups is given according to appropriate situations, such as out-patient waiting areas, inpatient wards, outreach clinics etc on the following topics

- Immunization
- Nutrition
- Family planning
- Ante-natal and post-natal care, mother's TT Immunizations
- Personal hygiene
- Cleanliness during food preparation and feeding times
- Proper environmental sanitation and other aspects concerning primary health care.

- Other relevant health topics e.g. PMTCT, VCT, Malaria control, ITNs etc.

## *ii) Weighing*

Weighing is done at every visit to monitor growth.

Requirements for weighing are:

- Weighing scales children;
- Weighing pants to put the child in;
- Table and chair;
- Weight scale for adults.
- Changing couch with mackintosh

The weighing station must have a place where you can place the hanging scale: in a warm room away from draughts. This applies to both static and mobile/outreach clinics, or put the table level for “beam balances”. Make sure the scale is clean and warm.

- Adjust the scale to read zero (to balance the weighing scale).
- Instruct the mother to remove the child’s clothes
- Place the child on the clean, dry scale.
- Tell and interpret the weight on the scale
- Plot the weight on the child’s growth monitoring card.
- Read the weight as shown on the child card to the mother.

## *iii) History taking*

- Ask if the child has any symptoms or if the mother has any other complaints.
- Ask her about the feeding habits of the child.
- Examine the child physically.
- Check for BCG scar on the second visit after the injection and during her subsequent visits.  
(If BCG scar is not visible three months after injection, repeat)

## *iv) Check immunization status*

- Look at the child’s growth monitoring chart and interpret it

- Look at the child's immunization status and vaccinate as appropriate
- Provide vitamin A supplementation as appropriate
- Ask the mother about her TT status and vaccinate as appropriate.

### *v) Counselling*

Discuss your findings on history taking, weighing and physical examination with the mother/guardian and give appropriate advice. (Give her compliments if the child is well looked after, if she is breast feeding, and if she has come on the right day and brought the child's card). Encourage her to continue infant feeding **until the child is two years old**. Discuss possible immunization reactions.

- Make sure your guidance and advice are appropriate.
- If no immunization are due today explain why
- Counsel on importance of growth monitoring and immunizations
- Encourage her to take care of the child's health card and bring it at each visit.
- Reassure and encourage mothers of sick children and explain the need to immunize their sick children unless they are hospitalized.
- Confirm that parents/guardians have understood and encourage them to ask questions

### *vi) Information to be recorded on each child's health card*

- The child's particulars
- Health status, weight, Nutritional status
- Any treatment given
- Today's immunization given
- The date for the next visit.

**Note:** The person who administers the immunization should record the date of the immunization.

### *vii) Treatment:*

- If the child is sick treat or refer as appropriate
- Confirm that parents/guardian have understood and encourage them to ask questions
- Give medicine as prescribed on the child's card
- Instruct the mother clearly on how to administer drugs to the child.

- Register the treatment
- Give him/her time to ask questions if he/she has any.

### *vii) Immunization*

Is fully discussed in Chapter 7

### *viii) Arranging equipment and materials at the immunization station*

You need a table to arrange the following:

- A vaccine carrier in which to place vaccines and keep them cold;
- Foam pads on top of the ice packs in the vaccine carrier to keep the vaccines cold.
- Adequate doses of vaccines.
- Auto-Disable syringes, Reconstitution syringes and needles.
- Dry cotton swabs in galipot or clean container.
- Tally sheet and summary sheets.
- Mother and Child Health Booklets and the TT cards.
- Permanent child registers and TT register.
- AEFI form.
- Near the table you should have Safety box for disposing used syringes and needles and refuse bins.
- A source of clean running water, soap, and disposable hand-drying materials.

### **Antenatal care (ANC)**

I) ANC services takes care of the mother's health during the pregnancy and prepare her for a normal and safe delivery of a live normal baby.

The following activities are carried out during an ANC clinic:

- Welcome the mother warmly
- If it is her first visit, take personal particulars.
- Weigh the mother and plot the weight on her ante-natal card

ii) Take complete history and examine the client. These should include:

- Past "obstetric history"

- Present pregnancy
- Her last menstrual period
- Examine her general condition as per focused ANC guidelines (FANC) – *refer to reproductive health manual*

### **(v) Management:**

- Check TT immunization status as per 5TT schedule and administer it if she is due for vaccination.
- Give her return date.

## **Post Natal Care (PNC)**

Mothers report for post-natal care as early as possible after delivery.

- Welcome the mother
- Check TT immunization status and administer it if necessary
- Examine the baby and ensure that the child has started immunizations (refer to schedule). Advise the mother on infant feeding, immunization and personal hygiene.
- Advise her to continue bringing her child for immunizations and weighing
- Examine the mother as per Reproductive Health Care guidelines.
- Advise her on family planning so that she can start the service immediately after the examination
- Give her and her baby their next appointment.

## **Points to remember in MCH**

- Keep vaccines cold in a refrigerator and maintain +2°C to + 8°C . Keep the refrigerator closed all the time
- Take out from refrigerator all vaccines you will need for the session and put them in a vaccine carrier
- Ensure that the vaccine carriers are closed all the time.
- Change the ice pack before temperature reach +8° c
- Be friendly to both the parents/guardians and children
- Check all children to see what immunizations they have had and what they are due for
- If in doubt, ask the parents/guardians and confirm from the card



- Look for presence of BCG scar
- Give immunizations to all children, even the sick ones, unless the child needs hospitalisation
- Remind the clinical officer/nurse to send sick children to you for immunization
- Check the time interval between doses or immunization. For DPT-HepB+Hib and OPV, Do not give second and third doses if the time interval is less than 4 weeks
- **REMEMBER:** Do not give birth dose of oral Polio after two (2 weeks). To avoid giving different return dates for **DPT-HepB+Hib, OPV and PCV**. At subsequent visits, start both antigens at six (6 weeks) and repeat at interval of 4 weeks.
- On the other hand, even if the time limit is long past the minimum interval of 4 weeks **give the next dose**
- **Do not start the schedule again.** E.g. if you see a child who had first dose DPT-HepB+Hib, PCV and OPV six months ago, give second dose *DPT-HepB+Hib, PCV and OPV*
- Mark on the tally sheet accordingly after each immunization you give. Remember to put down the date of immunization. Fill in the mother and child card properly as shown in Chapter 9
- Make sure you explain clearly to the mother when to come for the next dose or the next immunization. Tell her she should come even if her child is sick
- Tell mothers about the reaction to expect from immunizations. Many mothers may have heard rumours. Reassure and tell them what to expect and how to respond
- Remember: Injectable immunizations need sterile procedures. Ensure your equipments i.e. AD syringes, reconstitution syringes and safety boxes are available and properly assembled.
- **USE ONLY ONE STERILE SYRINGE AND NEEDLE FOR EACH INJECTION.** After use, dispose it into safety box immediately at the point of use.
- After the clinic session, take all tally sheets and fill in the monthly summary sheet. Clean and tidy up the clinic before you go off duty, ready for the next day.

## Outreach/Mobile services

Effective patient's/client flow will facilitate your smooth clinic management

Fig 5.1 A sketch of an outreach clinic



## Organization

An outreach clinic is where you take MCH services and curative services from a health facility to the community within the catchment area and return back to the health facility the same day.

*A mobile clinic is taking MCH services to a community, lasting for more than one day without returning to the health facility.*

An outreach immunization session is held in a location where the health workers can go out and return the facility the same day. They are held periodically, at interval of one, two or three months. For success outreach sessions in a community should be held in the same place (for example school), on the same day of the week and at the same time, to maximise the likelihood that people will remember to attend.

## Scheduling days and times for outreach sessions

Schedule outreach sessions at least one month apart; the multi-dose vaccines DPT-HepB+Hib, OPV and Tetanus Toxoid require an interval of at least a month between doses.

Activities involved in an outreach or mobile clinic include:

- Determine the need for outreach clinics in terms of access and utilization

- Determining the size of target population and the number of children and women that you can immunize in one session
- For the best results, consult with community leaders and clients about dates and time, as they will help mobilize the community.
- Discuss your plans for mobile/outreach clinics with the members of the DHMT
- Make sure you tell mothers which days to expect you, and the time session will start. *Be reliable and punctual.*
- Make sure that you keep vaccines cold (+2° to +8° degrees Centigrade).
- When you arrive, arrange your mobile or outreach clinics similar to that of your static health facility
- Once the immunization session starts, open your cold box or vaccine carrier once, take the vaccines you need according to the number of mothers and children expected and put them on holes in the sponge which is replaced on vaccine carrier during the session, replace ice packs as soon as the ice has melted. Carry a spare vaccine carrier/cold box with icepacks for replacement.
- Complete the immunization tally sheet and remember to transfer the data and the name of the outreach clinic to the immunization summary sheet

## Completing an outreach session

### 1. Repacking the vaccine carrier

- Note the temperature inside the vaccine carrier at the end of the session. If the temperature is greater than +8°C, Vaccines should be discarded unless VVM shows that it is still safe for use. (Has not reached discard point).
- Pack unopened vaccines and open vials for which multi-dose vial policy is applicable.
- Put empty vials and vials to be discarded in a separate container to be carried back to facility for proper disposal.

### 2. Leave outreach site tidy

- Do not leave behind anything that might be a health risk to the community.
- Collect safety boxes containing sharps and take the safety boxes back to the facility. Do not to leave any syringes and needles at the site.
- The health worker should supervise the burning of other wastes on site.
- Do not to leave any empty or glass vials at the site.

- Return tables, chairs and other equipments to the owners.
- Thank the local people who have helped to organise the session and remind them when you will return.

### 3. At the facility

Return vaccines to the refrigerator:

- If the ice packs in your vaccine carrier have melted during your trip back to the health facility and temperature is above +8° c, and VVM has not reached discard point. Return the vaccines in the refrigerator and indicate **use first** so that they will be used first during the next session
- Put ice – packs into the freezer, check and record the temperature.

## EXERCISE

Role-play:

- Participants should be able to prepare and present a role-play of immunization in an MCH clinic.
- Your role-play should last about 10 to 15 minutes so that you can cover all the aspects of an MCH clinics on the following:
  - *Organization of an immunization session.*
  - *Micro-teaching*
  - *Negotiating with the community on outreach service.*
- Use what has been discussed in this chapter to critique the role-play.

This chapter discusses the practice that a health worker should follow to ensure that EPI immunization injections are given in the safest manner.

# ENSURING THAT IMMUNIZATION INJECTIONS ARE GIVEN SAFELY

## CHAPTER

# 6

### Learning objectives

By the end of the session, participants will be able to:

- State what is unsafe injections
- Describe steps in ensuring safe injection
- Explain how to prevent needle stick injuries and infections
- List unsafe immunization practices;
- Discuss safe ways of disposing used syringes and needles immediately at point of use
- Describe the methods of waste disposal;

### SAFE AND UNSAFE INJECTION

#### *What is a safe injection?*

A safe injection is one that does not harm the recipient. Nor expose the health worker and the community to any risk.

#### **An injection is considered safe for:**

- *The mother or child*, when a health worker uses a sterile syringe and a sterile needle and appropriate injection technique;
- *The health worker*, when he or she avoids needle- stick injuries; and
- *Community*, when waste created as a result of used injection equipment is disposed off correctly and does not cause harmful levels of pollution and injuries

#### *What is unsafe injection?*

An unsafe injection is one that can result in transmission from one patient to another such infectious complications as HIV/AIDS, Hepatitis B and C and malaria. Transmission from patient to health worker has also been reported in some health care settings.

### *Some common injection practices that can cause harm to the recipient*

- Re-using a syringe or needle.
- Changing needle but re-using syringe.
- Loading syringe with multiple antigens and injecting multiple persons.
- Leaving needle on the vial for withdrawal of additional doses.
- Touching sterile parts of syringe and needle.
- Applying pressure to bleeding injection site with used materials or dirty fingers.
- Keeping freeze-dried vaccines for more than 6 hours after reconstitution.
- Mixing two partial opened vaccines to constitute a dose.
- Storing medications and vaccines in the same fridge.

### *Practices that can harm Health worker*

- Recapping.
- Placing used needles on surfaces or carrying them from point of use for disposal at a designated area.
- Sorting out mixed health care wastes.
- Using injection equipment for non-injection purposes.

### *Practices that harm the community*

- Leaving used syringes and needle in unprotected areas where they can be easily accessible to children and grazing animals.
- Community can also be at risk when injection equipment is carelessly disposed off and because of its commercial value, it can be retrieved, resold and reused.

## **STEPS AIMED AT PROMOTING INJECTION SAFETY**

**Table 6.1: Equipment used to administer vaccines**

Equipment	Remarks
Auto-disable (AD) Syringes	Equipment of choice
Pre-filled AD injection device	Available for some antigens only
Single use disposable (non-AD) syringe and needle	For reconstitution of vaccine

### *Auto-disable (AD) syringes*

AD syringes are self-locking syringes that can be used only once. An AD syringe is the recommended equipment for all immunization injections.

Most AD syringes have fixed needles and there are different AD size syringes for different vaccines like BCG and others.

With AD syringes the plunger can go back and forward only once, so health worker should not move the plunger unnecessarily as this will disable the syringe.

Always keep the needle tip in the fluid at all times, making sure to empty the full contents of the vial. To remove air bubbles, hold the syringe upright and tap the barrel. Then carefully push to close the mark.

When administering vaccine, push the plunger forward and inject the vaccine. After injection, the plunger will automatically lock and the syringe cannot be re-used. Do not recap the needle after use; dispose it immediately into a safety box.

### *Pre-filled AD injection devices*

These are single-dose packets of vaccine with a needle affixed by the manufacturer. They can only be used once and should be disposed immediately at point of use into the safety box.

### *Re-use prevention syringes and needles*

These are syringes and needles used for reconstitution of vaccines such as BCG, measles, HIB (Haemophilus influenza) and yellow fever and are disabled to avoid reuse.

### *Estimating AD syringes/reconstitution syringes and needles and safety boxes*

It is important to ensure that you have sufficient stock of AD syringes/reconstitution syringes and needles and safety boxes to conduct planned fixed and outreach sessions (refer to chapter vaccine 4 management pg ----)

### *Giving the right vaccine safely*

Other than using the injection equipment safely it is equally important to give the right vaccines that has been kept properly in the cold chain, appropriately reconstituted and safely administered.

**Table 6.2 Examples of incorrect immunization practices and Possible reactions following immunizations**

Incorrect practice	Possible reactions
<p>Non-sterile injection</p> <ul style="list-style-type: none"> <li>• Reuse of disposable syringe or needle</li> <li>• Contaminated vaccine</li> <li>• Poor preparation of injection site.</li> <li>• Poor hand hygiene and compromised skin integrity of the health worker.</li> </ul>	<p>Infections such as abscess, sepsis, toxic shock syndrome. Blood-borne infections such as HIV, hepatitis B and C</p>
<p>Reconstitution error</p> <ul style="list-style-type: none"> <li>• Inadequate shaking of vaccine</li> <li>• Reconstitution with incorrect diluents</li> <li>• Drugs substituted for vaccines or diluents</li> <li>• Use of reconstituted vaccine beyond 6 hours or in subsequent sessions</li> <li>• Reconstitution with warm diluents</li> </ul>	<ul style="list-style-type: none"> <li>• Local abscess</li> <li>• Cold abscess and Vaccine ineffectiveness</li> <li>• Negative effects of drugs, e.g. insulin, muscle relaxants</li> <li>• AEFI including Death</li> </ul>
<p>Injection at incorrect site</p> <ul style="list-style-type: none"> <li>• BCG given subcutaneously</li> <li>• DPT+HepB-Hib too superficial</li> <li>• Injection into the buttocks</li> </ul>	<ul style="list-style-type: none"> <li>• Local reaction or abscess</li> <li>• Local reactions or abscess</li> <li>• Sciatic nerve damage</li> </ul>
<p>Incorrect vaccine transportation and storage</p> <ul style="list-style-type: none"> <li>• VVM at or beyond discard point</li> <li>• Clumping of frozen vaccines</li> </ul>	<ul style="list-style-type: none"> <li>• Local reactions or abscess and Vaccine ineffectiveness</li> </ul>
<p>Contraindication ignored</p> <ul style="list-style-type: none"> <li>• History of hypersensitivity reaction to vaccine</li> </ul>	<ul style="list-style-type: none"> <li>• Avoidable severe reactions</li> </ul>

## PREVENTING NEEDLE-STICK INJURIES AND INFECTIONS

Needles frequently injure health workers and may result in transmission of blood-borne diseases like hepatitis B, C and HIV.

***Needle-stick injuries occur:***



- When health workers recap the needle or walk while carrying used syringe and needle.
  - *If children are not positioned securely while they receive injections.*
  - *If unsafe disposal practices leave people exposed to used syringes and needles.*

### *Minimize the risk of needle-stick injuries*

Needle-stick injuries can occur at any time, but they happen frequently during and immediately after an injection is given. To prevent needle-stick injuries one needs to observe the following:

- Do not recap the needle.
- Place safety box within reach to facilitate immediate disposal of syringes and needles at point of use. Do not carry used syringes and needles around working area.
- Do not manually remove the used needle from the syringe.
- After injection dispose syringe into the safety box at point of use immediately.
- Fill safety box three-quarter wayfull andclose it securely.
- Do not manually sort needles and syringes.

### *Handwashing - Infection Prevention and Control*

Hand washing equipments should be placed next to immunizing table for ease of access. Hand washing reduces micro-organisms therefore minimizing cross infection from health workers hand to the patients body.

- Health worker must wash hands prior to giving first immunization and when they come into contact with dirt or blood.
- Adhere to a septic technique when handling sterile syringe and needles, observe the DO'S and DON'TS of injection safety.

### *Handling syringes and needles safely*

You have to hold a syringe to give an injection, but should not touchpart that comes into contact with the vaccine or the child.

#### ***Do not touch:***

- The shaft of the needle;
- The bevel of the needle;
- The adaptor of the needle;
- The adaptor of the syringe; and

- The plunger seal of the syringe.

Figure 4B: Parts of a syringe and needle that must not be touched

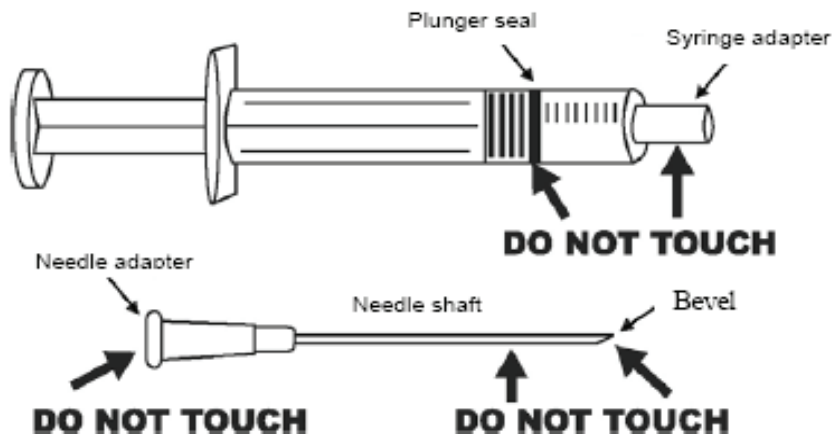

**IMPORTANT:** If you touch any of these parts, discard the syringe and needle and get new sterile ones.

**If you touch any of these parts, discard the syringe and get new sterile ones**

*You may touch:*

- The barrel
- The plunger top

Figure 6.1 Parts of a syringe and needle that may be touched

**Immunization work area to minimize risk of injury:** Health workers should plan the layout of their work-place ensure that:

- Vaccine carrier is in a safe and cool area;
- Tally sheets can be easily used;
- Person administering vaccine is between the child and the injection sharps or safety box;
- Health workers dispose used needles at point of use without moving too far;
- Each injection area to have its own safety box;

*Positioning children correctly for injections*

Unexpected motion at the time of injection can lead to accidental needle-sticks. To prevent this, position the child securely before giving injection.

- Have the mother sit and place the child on her lap. Make sure one of the mother's arms is behind the child's back, and one of the child's arms wraps around the mother's side.
- The mother may tuck the child's legs between her own to secure them, or she may hold the child's legs.
- Health worker should avoid holding the child as they require to use both hands to administer the injection;

Always tell the mother when you are about to give the injection;

**Figure 6.2 Correct position for the child receiving injection**

---



Child receiving PCV vaccine



Child receiving pentavalent vaccine



Child receiving measles vaccine



Child receiving yellow fever vaccine

**EXERCISE:** Practical group exercise to practice on how to:

1. Assemble safety box

## IMMUNIZATION WASTE MANAGEMENT

This section aims to update Health workers on safe disposal of immunization wastes that does not become a health hazard to the community and the environment

### *Specific Objectives*

1. To define safe waste disposal
2. To describe terminologies used in Health care waste management
3. To describe the common waste disposal methods for immunization waste
4. To describe the role of facility in-charges, vaccinators, safety officers (PHOs) and the waste handlers in immunization waste management.
5. To outline advocacy and social mobilization strategies used for waste management activities
6. To conduct supervision, monitoring and evaluation for waste management activities

### *Importance of proper waste disposal.*

The main objective of safe handling and disposal of sharps waste is to prevent infections to health workers, waste handlers, and the community at large.

Unsafe disposal can spread some infections such as HIV/AIDS, hepatitis B and C, which are transmitted through injuries from needles contaminated by human blood.

### **Definition**

Waste are materials or products made useless for any further use e.g. used syringes and needles.

### *Terminologies used in waste management*

**Segregation of waste:** This is the separation of wastes at points of generation into different and distinct containers or bags according to national colour codes. Segregation should be separated in to harmful (hazardous) and non-hazardous waste. Proper waste segregation should be able to minimize hazardous waste requiring special handling.

**Safety Box:** A safety box is a leak and puncture proof container that carries 100 syringes and needles when  $\frac{3}{4}$  full.

Safety box is filled to  $\frac{3}{4}$  full level to avoid spillage, needle stick injuries and to ease the sealing of safety box and should be stored safely awaiting transportation to the central disposal site.

Safety Box Precautions.

- Do not open used safety boxes or emptied for Re-use.
- Do not squeeze or force syringes inside the safety box.

**Colour coding:** Yellow bag---for hazardous wastes

Black bag--- Non-hazardous wastes

Red bag—Infectious wastes

Sharps--- disposed all the used sharps into the safety boxes immediately at point of use.

## Safe waste disposal methods

**Incinerator:** This is a structure constructed of bricks for the burning of wastes

There are a number of models of incinerators available in the market. They are De Monfort, SICIM and Medicin 400 which uses gas as source of fuel.

### *Incineration*

Incineration completely destroys needles and syringes by burning at temperatures above 800°C. The high temperature kills microorganisms and reduces the volume of waste to a minimum and produces less air pollution than open burning. Some hospitals incinerate on-site while others transport waste to a central incineration area in the district /division.

Burning in a metal drum (container burning)

If no incinerator is available, burning in a metal drum or protected hearth is another way to dispose of used injection equipment and contaminated needles.

### *Open pit burning:*

Requirements

- Fence off the area in which open burning takes place
- Carry the waste to the site just before burning
- Warn people to stay away and avoid smoke and fumes from the fire.
- Prevent animals or people from accessing the site.

- Prevent the waste from scattering and littering the surrounding area.
- Make sure the fire is completely out before leaving the site.
- If safety boxes are placed in an open pit, the pit should not be so deep that people have to crawl down into the pit to start the fire.

### *Open burning*

If open burning must be done, Public health officers & waste handlers should:

1. Choose an unused part of the compound for burning site, as far from buildings as possible. Be sure to select a site where people will not dig to plant crops or establish latrines
2. Fence off and clear the area
3. Dig a pit at least 1 meter deep
4. Take the filled safety boxes to burning site just before burning. Do not open or empty the boxes
5. Place the filled safety boxes into the pit. Mix paper, leaves, or other flammable material among the safety boxes to help them burn
6. Sprinkle a small amount of kerosene on the boxes in the pit, and then ignite the fire
7. Warn people to stay away and avoid smoke and fumes from the fire
8. Allow burning until all the boxes have been destroyed
9. Once the fire is out and the residue at the bottom of the pit has cooled, cover the residue with at least 13 cm of soil. Cover the site with concrete when the pit is full to prevent digging in the future
10. Open burning should always be carried out under the supervision of a qualified staff member. Do not leave this vital task to unqualified people!

### **Waste management officer should**

- Identify practical, simple solutions for waste disposal at the facility
- Where there is no disposal facility within the institution work out an arrangement to transport waste to an available incinerator.
- Prepare clear instructions for health staff on sharps disposal and waste management.
- Supervises and monitors to ensure recommended waste management practices are adhered to

- Select the most appropriate waste disposal option.
- To play technical advisory role to the waste management committee

### *Role of Waste handler:*

To collect safety boxes, and deliver them to the disposal site.

To load the incinerator/burn/bury the wastes depending on the disposal method used.

Ensures safe final disposal of wastes

### *Precautions for waste handlers*

- Prevent exposure to the molten plastic and blowback heat from the combustion chamber of the incinerator.
- The waste operator should be protected from low levels of emissions from the waste gases and smoke.
- Handle sharps in ash and debris after burning / incineration safely to avoid being pricked by remaining stubs of burned needles.
- Allow the ashes to cool after burning and incineration for safe handling.
- Avoid hot surfaces that are likely to cause burns to the workers

### *Waste handlers requirements*

- *Heavy-duty gloves*
- Goggles (plastic)
- Mouth protection gears.
- Heavy-duty boots
- Rakes and fire pokers for incinerator.
- Wheel barrow
- Fire resistant overcoat
- Ash removal spade with long arm handle
- Helmet or cap.

The health staff should be aware of:

- The potential health risks related to unsafe injection practices. (poor waste disposal)
- The importance of safe waste disposal.

- Community based channels for information on waste management.

They should sensitize communities on:

- The importance of using new sterile disposable injection equipments
- Health risk associated with unsafe injection practices and poor disposal of medical wastes
- Their roles in supporting proper medical waste disposal
- Need to refer accidents related to poor waste disposal to health facility

## ADVERSE EVENTS FOLLOWING IMMUNISATION (AEFI)

### *Introduction*

The goal of immunization in Kenya is to protect the public from vaccine preventable diseases. Modern vaccines are safe; although after immunization, some people may experience reactions; ranging from mild local reactions to life-threatening illnesses.

### *Broad objective*

To assist health workers improve their knowledge, skills and knowledge towards AEFI.

### **Specific Objectives:**

1. Define AEFI
2. How to identify AEFI
3. State the possible causes of AEFIs.
4. To detect and report AEFI
5. State the steps involved in investigating adverse events.
6. Outline the steps taken in managing AEFI cases.
7. Describe how to prevent cases of AEFI.

## What is Adverse Events Following an Immunization?

### *“Programme errors”*

An adverse event following immunization is a medical incident that that occurs during or after an immunization and is believed to be caused by immunization.

### *Detection and reporting*



Health workers should detect and report the following:

1. Anaphylactic shock
2. Injection site abscesses.
3. Cases of BCG lymphadenitis
4. Cases requiring hospitalizations that are thought by health workers, or the public, to be related to immunization
5. Unusual medical incidents that are thought by health workers, or the public, to be related to immunization.
6. Deaths that are thought by health workers, or the public, to be related to immunization.

In routine surveillance the health worker is expected to submit a report of any AEFIs identified to the supervisors at the district level. The district supervisors then compile the data for reporting to the next level.

### **How to identify AEFI**

The cardinal signs of anaphylaxis are:

- Itchy, urticarial rash (in over 90% of cases)
- Progressive, painless swelling (angioedema) about the face and the mouth, which may be preceded by itchiness, tearing, nasal congestion or facial flushing
- Respiratory symptoms, including sneezing, coughing, wheezing, and laboured breathing; upper way swelling (indicated by hoarseness and/of difficulty swallowing) possibly causing airway obstruction
- Hypotension, which generally develops later in the illness and can progress to cause shock and collapse.

It must be differentiated from fainting, anxiety and breath holding which are more common and benign reactions.

Steps of managing anaphylaxis are:

1. Place the patient in a recumbent position (elevated feet)
2. Establish an oral air way if necessary
3. Check respiration and pulse

4. Promptly administer 0.01 ml/kg (maximum 0.5 ml) of aqueous epinephrine 1:1000 by subcutaneous or intramuscular injection in the limb (opposite limb to where the vaccination was given); speedy intervention is of paramount importance. Repeat at 20-minute interval if necessary.
5. Monitor vital signs and reassess the situation frequently, to guide medication use.
6. Arrange for transfer and refer to an emergency department.

Since anaphylaxis is rare, epinephrine vials and other emergency supplies should be checked on a regular basis and replaced if expired

**N.B Replenish the emergency trays with epinephrine ampoule and replace expired ampoules**

### *Injection site abscesses*

Signs of injection abscess are swelling or hard nodule at the injection site. That may progress into painful swelling and burst into a wound.

Management:

1. Reassure the mother/care giver/guardian.
2. Manage the swelling according to presentation

### *Assess for BCG lymphadenitis*

Refer to chapter 7 on management of BGC abscess.

## **Possible Causes of AEFI.**

- **Programmatic errors:** Usually they are person based i.e. an error in handling, reconstitution or administration of the vaccine.
- **Nature of the vaccine** (vaccine properties) or individual response to the vaccine itself.
- **Coincidental**, is an event that has no causal association between the immunization and the medical condition of the child or woman.
- **Unknown cause.** The cause of the event cannot be determined.

## **Conducting AEFI Investigation**

Investigation should begin ideally within 24 hours of detection by a health worker in order to:

- Identify any programme errors that might still be present,

- To correct them as soon as possible before other people are exposed.
- Stocks of reporting forms should be maintained and distributed as needed.
- Clusters of non-serious AEFIs should be investigated and a decision taken whether to report them to a higher level.

Following a report of a serious AEFI, the district managers should be responsible for investigation, collection and reporting of data. This may be under the overall supervision of a national team.

## Why AEFI is an important Area to Address in Immunization

An AEFI may upset people to the extent that they refuse further immunizations for their children.

- Their refusal to accept the vaccine puts children at risk of vaccine-preventable diseases and their consequences.
- The health worker should be able to diagnose, treat and report all AEFIs

Non-significant reaction to vaccines includes:

- Fever,
- Redness or swelling at the injection site,
- Rash.

Remember, children in the immunization age group may have symptoms unrelated to immunization due to common infections at the same time.

## The key action points on AEFI

To increase immunization acceptance and improve the quality of services through the proper surveillance of AEFIs **by:**

- Detecting and reporting AEFIs as they occur.
- Investigating AEFIs when they occur.
- Analyzing reports of AEFIs
- Taking appropriate action following reports of AEFIs.
- Evaluating the reporting system for AEFIs.
- Preventing AEFIs in routine immunization and mass campaigns

Supervision will greatly contribute to the reduction of this unwanted phenomenon.

## The purpose of investigation

- Clarify the outcome of the medical incident/s
- To identify the vaccine used (batch number, expiry date etc.)
- To confirm whether a reported event was a single incident or a cluster.
- To determine whether un-immunized people in the same area are experiencing the same medical incidents.
- To allay the fears rumours immediate action is also important to assure members of the community that their health and concerns are taken seriously.
- What data is required for AEFI case Investigation?

For this purpose, analysis of data on AEFIs consists of:

- Reviewing the case investigation report for each patient,
- Other data about the event and the community in which it took place,
- Reviewing laboratory results,
- Making a final diagnosis, and identifying the probable cause.

## Who does AEFI data Analyses?

- The health worker who detects the event and conducts the case investigation can carry out AEFI data analysis at initial stage.
- Epidemiologist
- Clinician
- Laboratory technician or
- Disease Surveillance coordinator.

The above-mentioned professionals can play a major role in determining the cause and in classifying the event. The central level manager responsible for AEFIs should direct and monitor the process. If the manager feels that additional data are required, he or she should re-examine initial sources to clarify the facts.

## Reducing Incidences of AEFI

### *Contraindications*

- Before immunization, ascertain client history for allergies and previous adverse reactions to vaccines.

- In the case of a possible serious allergy, check with the appropriate supervisor before giving vaccine.
- This procedure will minimize the occurrence of anaphylaxis but will not remove the risk altogether.
- Low-grade fever, mild respiratory infections and other minor illnesses **should not** be considered as contraindications to immunization. Diarrhoea should not be considered a contraindication to OPV. It is particularly important to immunize children suffering from malnutrition.

### *Precaution on Allergic Reactions previously experienced*

Do not give the second or third DPT<sub>Hep</sub>+Hib injection should not be given to a child who has suffered such a severe anaphylactic reaction to the previous dose. Because these events are so rare, it is not known which component of the combined DTP (or additional antigens in the combination vaccines) is responsible for allergic reactions. Therefore, no further dose of any of the vaccine components should be given unless assessment implicates the responsible antigen.

### *False contraindications*

Many immunisation personnel have long lists of contraindications, most of which are inappropriate some of which are as follows:

- Low-grade fever,
- Mild respiratory infections and
- Diarrhoea should not be considered a contraindication to OPV
- Other minor illnesses.

Such minor illnesses **should not** be considered as contraindications to immunization. It is particularly important to immunize children suffering from malnutrition.

### *Programme error*

All the effort so far is wasted if action is not taken to correct the error. If an AEFI was caused by programme error, such as improper handling of vaccines or faulty immunization technique, the actions to be taken will probably include one or more of the following:

- **Logistics:** Improving logistics will be the appropriate response if investigations indicate lack of supplies or equipment or failure of the cold chain. Health workers should investigate suspected faults in the cold chain to find the cause and take appropriate measures. Sometimes the problem might be solved by providing additional equipment (needles, syringes, sterilizers, vaccine carriers, cold packs), vaccine or diluent.

- **Training:** Trainings often used to solve operational problems: lack of skills and knowledge and poor attitude of health workers.
- **Supervision:** Non-serious AEFIs (e.g. abscesses) reported to the health facility should be able to alert the health worker to seek for the cause for immediate corrective action.
- **Communication:** Health workers should inform parents and the community about AEFIs, and assure them of immunization safety. Health workers should be prepared to respond quickly to rumours and public inquiries.

The key to maintaining confidence in health services is to be honest. If the cause of the AEFI has not been identified, people should be told.

A vaccine-induced AEFI can be a sensitive communication problem. The public needs to be assured that severe vaccine-induced events are rare, although this may not comfort the patient's family. The best that can be done is to show genuine sympathy and concern.

Evaluate the quality of AEFI surveillance

AEFI surveillance should be evaluated regularly and should lead to remedial actions.

Most of the indicators for evaluating AEFI surveillance are similar to those used to measure the performance of the disease surveillance system in general. Others are specific for AEFIs:

- Timeliness, completeness, and accuracy of routine AEFI surveillance reports
- Swiftness with which case investigation begins after a trigger event is reported
- Appropriateness of actions taken to avoid further programme errors
- Participation of communities in immunization programmes.

### How should the system be evaluated?

- **Completeness,** timeliness, and accuracy of reporting. Checking of the report receipt dates is also useful to districts and higher levels to monitor timeliness of reporting.
- **Accuracy.** Health workers should periodically check the accuracy of routine disease surveillance reports and observe their work to make sure that recommended improvements have become a part of daily practice.
- **Swiftness.** At the end of each AEFI investigation, the health worker should evaluate how quickly the response to the reported AEFI was done, using the following parameters:
- Whether the AEFI was reported within 24 hours of detection.

- Whether an investigation begun within 48 hours after the report was received.
- **Appropriateness of actions taken to avoid further programme errors.** Health should review case investigation and event description reports to see that the actions proposed for the elimination of programme errors are adequate.
- **Participation in immunisation programmes by communities.** Over time, a good AEFI surveillance should result in an increase in immunization coverage due to increased community participation. If the health worker reduces the programme errors to a minimum or even to nil, if he or she takes immediate and appropriate measures when AEFI occurs:
  - *If communities are well informed on causes of AEFIs,*
  - *The confidence in immunization and in the staff will grow in the community, resulting in increased participation.*
  - *Monthly AEFI surveillance reports, AEFI annual reports, and coverage data can be used for this assessment.*

# KEPI VACCINES AND TECHNIQUE OF ADMINISTRATION

This chapter describes the immunization schedule and the six KEPI vaccines:

## Main objectives

Describe the EPI vaccines and their administration.

## Learning objectives

- Identify the EPI vaccines.
- Discuss the rationale for giving each vaccine.
- State the storage temperature of each vaccine.
- Explain the National Immunization Schedule.
- List requirements for each vaccine.
- Explain preparation of each vaccine to be administered.
- State the site for administration with the dosage used.
- Describe possible expected reactions after vaccination
- Educate the parents/guardians on what to do in case of a reaction.

The following are the EPI vaccines currently in use:

- BCG
- Oral Polio
- DPT/HepB-Hib (Pentavalent)
- PCV
- Measles
- Tetanus Toxoid



- Yellow Fever

## **BCG -Bacilli Calmette-Guerin vaccine**

BCG is a freeze-dried live attenuated vaccine prepared from *Mycobacterium Bovis*. It has a life-span of up to 12 months from the date of preparation, when kept under the right temperature of +2°C to +8°C.

### ***a) Why do you give BCG?***

BCG immunization protects against tuberculosis (TB), which is one of the common diseases in Kenya. BCG prevents severe forms of TB, e.g. TB meningitis and TB in non-immunised infants. This is why it is so important to begin immunization at birth as recommended by the National Immunization Schedule.

BCG immunity is estimated to last between 7-15 years. Only one administration is recommended in the schedule.

### ***b) How to store the BCG vaccine at facility level.***

- BCG vaccine should be stored continuously at +2°C to +8°C.

### **c) When should you give BCG?**

- BCG vaccine should be given at birth or at first contact.
- BCG vaccine is usually given to children up to the age of 5 years, if no BCG scar is present.
- Contacts of persons above 15 years who are not suffering from TB and have a negative Mantoux test, should be immunized with BCG immediately.

### ***d) When not to give BCG:***

- There are no absolute contraindications besides symptomatic HIV/AIDS and other known immune-suppression diseases e.g. cancers.
- BCG should also be withheld in cases of acute illness needing hospitalisation but be given on discharge.

**Note:** It is advantageous to immunize at birth as recommended because none of these contraindications will apply.

### ***e) How to give BCG, Route and dose***

- BCG is given through *intra-dermal* route, which is found to be the most efficient in immune conversion.

- It produces a lasting scar as an indicator for immunization
- The dose is 0.05 ml for children less than 1 year or 0.1 ml for children above 1 year.

**f) What are the requirements for administering BCG vaccine?**

- Sterile AD BCG syringes with needles gauge 26.
- Sterile 2ml reconstituting syringe and needles gauge 21
- Safety box
- A vaccine carrier with ice packs and a sponge
- Refuse bin

**g) How to prepare the BCG vaccine:**

Always open ampoules of BCG vaccine with great care, because sometimes a vacuum is maintained inside the ampoule.

- Wash your hands
- Dilute the vaccine under sterile conditions with a cold diluent.
- Transfer the diluent with a dry sterile 2 ml syringe using gauge 21 long needle into the ampoule/vial containing the vaccine.
- Gently mix the vaccine well before filling the syringe.
- Withdraw the vaccine with needle and syringe, and then discharge it back into the ampoule twice or thrice to give a homogenous solution.
- If the vaccine comes in a vial, use non-touch technique and withdraw the diluent and mix as described above.

**Note:** in case of ampoule

- File the ampoule on the neck.
- Take care to avoid harming yourself by covering the ampoule neck with clean cotton swab
- Break the ampoule neck.
- Remember, BCG is very sensitive to sunlight and heat.
- Keep the reconstituted vaccine in a sponge with a slit in a vaccine carrier.
- BCG potency lasts for six hours after being reconstituted.
- Reconstitute the vaccine as soon as the first eligible child for BCG reports at the clinic.

- Record time of reconstitution.
- Discard reconstituted BCG vaccine after 6 hours or at the end of immunization session whichever comes first.
- Never store diluted BCG vaccine for next day's use.
- Open a BCG vaccine vial even if only one child is to be given the immunization.

***i) How to fill the syringe:***

Allow the ampoule/vial to stand upright on the sponge in the vaccine carrier for about one minute to let bubbles disappear. Fill the syringe with the required dose of the vaccine using the BCG AD syringe.

Withdraw one dose at a time to avoid exposure of the reconstituted BCG vaccine. Measure the volume of vaccine to be injected according to the markings on the barrel of the 0.05 ml syringe for children less than 1 year and 0.1 ml syringe for children over 1 year.

**Note:** Do not withdraw several doses in advance.

***j) How to inject the vaccine:***

With your left hand, hold the left forearm of the child to be immunized.

- Stretch the skin over the site between your left index finger and thumb.
- Introduce the needle upwards, into the skin, keeping it as flat as possible, so as to give it intradermally.
- Inject BCG vaccine intradermally on the outer (dorsal) aspect of the left forearm at the junction of the upper and middle thirds.
- When you give the injection intradermally into the lower layer of the skin, a wheal appears (about 7-8 mm) with small pits on it like an orange peel.
- Remove the needle and do not rub the site.
- Caution the parent/guardian not to rub the site or apply anything on it.

***k) What happens after BCG IMMUNIZATION?***

- The wheal will form and disappear in about half an hour. After two weeks a small red induration nodule (measuring about 10 mm) appears and lasts for about two weeks or more. Sometimes the nodule may appear earlier (in 3-8 days) which means that the individual had a certain degree of hypersensitivity. This is called an “accelerated indurated reaction”.

- The skin over the nodule abscess ulcerates in a further two weeks (sixth week) after immunization, measuring about 10 mm. This ulcer heals spontaneously and leaves a small scar measuring about 5- 7 mm. If no scar appears after 12 weeks, repeat BCG immunization.

**Note:** BCG induced immunity commences about 6 weeks after vaccination.

### l) Minor side effects/complications

BCG vaccination complications are rare, but some minor side effects may occur such as:

- Acute inflammatory reaction at site of the injection. This appears within 2 - 4 days of immunization. It is unexpected but heals rapidly on its own, leaving a small flat scar.
- Deep abscesses at the immunization site. These are due to injecting the vaccine too deep in the subcutaneous layer of the skin instead of the intradermal layer.
- No medication is required but if necessary apply sterile dry dressing.
- Very occasionally, deep abscesses may require aspiration.
- When they do, reassure the parent/guardian and refer child for further management.
- Excessive ulceration is when an ulcer is still present more than 12 weeks after immunization, or one which is more than 1 cm. No treatment is required but apply a sterile dry dressing.
- Lymph node enlargements sometimes occur. If they ulcerate refer for further management.

### m) BCG records:

Remember to record the immunization in.

- Mother and Child Health Booklet
- Tally Sheet
- Permanent Child Register

**Note:** BCG is the first vaccine you give to every child. Therefore, this being the first contact with the child and mother, a positive first impression will encourage her to seek further immunization.

## POLIO VACCINE

Oral Polio Vaccine (OPV) is a live attenuated vaccine made from the three types of polio virus: type I, II and III. It is ready for use in a vial. The vaccine is very sensitive to heat and light. Injectable Polio Vaccine (IPV) is given by subcutaneous injection. Although IPV is not currently included in the child immunization schedule, there are plans for it to be introduced into the child immunization schedule soon in order to strengthen polio eradication efforts.

### ***a) Why do you give oral polio vaccine?***

Oral polio vaccine is the vaccine of choice in Kenya for primary immunization of children because:

- It is given at birth since there is no maternal antibodies transfer.
- It induces intestinal immunity, besides producing antibodies in blood.
- OPV coverage of 80% and above induces herd immunity.
- It is simple to administer orally, well accepted by children and mothers.

It has eliminated wild polio virus in countries where it has been widely used.

### ***b) When do you give OPV?***

At birth or at first contact with the child up to 2 weeks.

- *First OPV* should be given at six weeks or at first contact with child after that age, together with first DPT/HepB+Hib vaccine.
- *Second OPV* should be given at 10 weeks or at next contact with child after that age, together with second DPT/HepB+Hib.
- *Third OPV* should be given at 14 weeks or at the next contact with child together with third DPT/HepB+Hib.

**Note:** The birth dose is counted as a Zero dose since the uptake of vaccine to the infants has not develop adequately.

### **Storage**

- Store OPV at +2°C to +8°C at facility level.
- Monitor Vaccine Vial Monitor (VVM).
- Stored at the coolest part of the refrigerator.

**Note:** The *interval between* the first, second and third doses must be at least one month apart. If you give the next dose of OPV before this minimum period of one month, there will be an interruption in the formation of antibodies.

There is *no maximum time interval* between two doses. Even if a year passes between successive doses of vaccine, do not begin the series again, as was the practice in the past. But remember, this delays the time when the child is protected.

***c) When should you not give OPV?***

Besides known impaired immunity, there is no contraindication to Oral Polio Vaccine.

***d) How to give OPV***

- Wash your hands.
- Always arrange to give the vaccine indoors or in the shade because it is very sensitive to heat and light.
- Keep OPV in a vaccine carrier throughout the immunization session between +2 to +8 degrees centigrade.
- Use the dropper or device supplied with vaccine. Put two drops, or as prescribed by the manufacturers, into the child's mouth.
- If the child does not open the mouth, gently squeeze the child's nose between two fingers.
- Do not touch the child's lips or tongue with the dropper. If this happens, finish giving the vaccine to the child, then discard the dropper.
- Make sure the child swallows. If the child spits the vaccine out, repeat the dosage.
- Make sure the mother knows the date for the next dose.

**Fig. 7.1: Child getting the polio vaccine**

---



***f) What are the possible reactions/complications?***

Vaccine reactions associated to paralytic polio are very rare.

***e) OPV recording***

Remember to record the immunization given in the;

- Mother and Child Health Booklet.
- Immunization tally sheet.
- Immunization permanent register.

## **DPT/HepB+Hib Vaccine (PENTAVALENT)**

***a) Why do you give DPT/HepB+Hib?***

DPT/HepB+Hib vaccine is called Pentavalent vaccine because it protects against five diseases namely diphtheria, pertusis, tetanus, hepatitis B, and Haemophilus influenza type B (Pneumonia, meningitis and epiglottitis).

***b) When should you give DPT/HepB+Hib?***

- Give the first dose of DPT/HepB+Hib vaccine at the age of six weeks or at first contact with the child anytime after that age, together with first OPV and BCG if not given before.
- If you give DPT/HepB+Hib vaccine before six weeks, the child may not be protected and can get the disease you are trying to protect them from.
- The minimum interval is one month as is with OPV. There is no maximum interval but, the sooner the child completes the series the sooner the child is protected.
- Second DPT/HepB+Hib vaccine should be given at 10 weeks of age, or at the next contact with the child after that age, together with 2nd OPV.
- Third DPT/HepB+Hib vaccine should be given at the age of 14 weeks, or at the next contact with child after that age, together with third OPV

Currently no booster dose is given.

***c) When not to give DPT/HepB+Hib:***

Do not give it to a child reported with convulsions after the previous dose. The “P” component is likely to cause convulsions, in such cases withhold the vaccine and refer the child to the clinician.

***d) What are the requirements for administration of DPT/HepB+Hib?***

- AD syringe and needle
- Vaccine carrier with sponge.
- DPT/HepB+Hib Vaccine
- Reconditioned ice-packs
- Waste disposal bin
- Dry single use cotton wool in a galipot.
- File top remover
- Safety boxes.

**Note:** During the immunization session, keep DPT/HepB+Hib on a sponge in a vaccine carrier with conditioned ice packs.

***e) How to give it:***

The dose is 0.5 ml. Give DPT/HepB+Hib vaccine intramuscularly in the upper outer aspect of the thigh. Do not inject children in the buttocks because of the danger of injuring the sciatic nerve and causing paralysis.

***f) How to prepare to give the vaccine***

- Wash your hands under running water
- Clean/swab the site if visibly dirty with freshly prepared swab,
- Divide the thigh into four imaginary quarters and take the upper outer part of the thigh as the injection site. The intra-muscular route induces efficient conversion and produces minimal reactions.
- Place your thumb and index finger on each side of the place where you intend to inject and stretch the skin slightly.
- Carefully push the needle into the space between your fingers. Go deep into the muscle so as to give an intra-muscular injection.
- Withdraw the needle and immediately discard it into the safety box.
- If site is bleeding apply slight pressure with a dry swab.
- Discard used swabs into a waste disposal bin.
- Tell the mother when to bring the child back for the next immunization.



***g) What happens after DPT/HepB+Hib immunization?***

There is often fever within 48 hours. Give antipyretic drug, e.g. equivalent of paracetamol adult tablet 8 hourly.

***h) What are the possible reactions / complications?***

- If there has been a failure in aseptic technique, there may be an injection abscess. If this happens, the mother should bring the baby back to the clinic for further management. Abscess may be severe and painful for the baby, but the worst effect of this abscess is that mothers lose confidence in immunization.
- A nodule may appear in the subcutaneous layer. Reassure the parent/guardian that it is a normal reaction but advice to seek medical advice if it persists.

## **Measles Vaccine**

Measles vaccine is a freeze dried live attenuated vaccine that has to be reconstituted with a cold diluent that is provided with the vaccine. It is supplied in 10 dose vial.

***a) When should you give measles vaccine?***

Maternal antibodies seem to remain in most children until the age of 6 to 9 months. If children are immunized before the age of 9 months, most of them might not be protected. This might lead to some mothers losing faith in the immunization. Immunization against measles with the present vaccine should not start earlier than 9 months. Measles vaccine can be given at the same time with any other vaccine e.g. a late pentavalent and BCG. Therefore, give measles vaccine at 9 months or at first contact with the child after that age.

Measles vaccine should be administered to all children admitted to the ward if they have not been immunized with two documented doses before and have no history of measles infection.

***b) When not to give measles vaccine:***

Measles vaccine should not be given to critically ill children due for hospitalization, but make sure it is given on discharge.

Minor illnesses are not contraindications, however, WHO recommendation is to give all vaccines except BCG and yellow fever.

***c) What are the requirements for administration of Measles?***

- AD syringe and needle
- A sterile 2mls reconstituting syringe and needle gauge 21
- Vaccine carrier with sponge.
- DPT/HepB+Hib Vaccine
- Reconditioned ice-packs
- Waste disposal bin
- Dry single use cotton wool in a galipot.
- File top remover
- Safety boxes.

***d) How to prepare to give measles vaccine (Refer to manufacturers guidelines)***

- Wash your hands.
- Remove the top cover of the diluent and of the measles vaccine to expose the rubber cap. Clean both tops with a cotton swab soaked in water. Note: The Measles diluent must be at the same temperature as the vaccine.
- Prepare the syringe to withdraw the diluent.
- Introduce the needle to the rubber top of the diluent and withdraw the amount required as recommended by the manufacturer.
- Discard the empty diluent bottle.
- Without contaminating the needle, introduce the diluent to the measles vaccine bottle. Shake the bottle a little to mix thoroughly before withdrawing vaccine. .
- Withdraw 0.5 ml, the remaining measles vaccine and keep it in a sponge in a vaccine carrier.

**Note:** Be careful not to expose the Measles vaccine to heat, light or contact with antiseptic or disinfectants as they destroy the vaccine

***f) How to inject the vaccine:***

The dose is 0.5 ml. Give measles vaccine subcutaneous in the outer side of the right upper arm, in the deltoid muscle as illustrated below at 45 degrees. (Confirm with the manufactures instructions.)



**Fig 7.2 Injection Site For Measles Vaccine**

- Show the mother how to hold the child firmly.
- This is an subcutaneous injection. Inject the same way as the DPT/HepB+Hib vaccine.
- Tell the mother about the possible reactions after measles vaccine, e.g. slight fever, running nose occurring 5 to 10 days after immunization, slight rash.

This mild illness shows that the vaccine is working to protect the child. The illness is always much less serious than the disease.

**Note:** Remember to record the immunization given. Discard measles vaccine 6 hours after reconstitution.

- ALWAYS REMEMBER TO REASSURE THE MOTHER.

**g) What can go wrong?**

In spite of having been immunized against measles, children are sometimes reported to have measles.

There are reasons for this apparent failure which include:

- The child may not have measles but some other viral infection with a similar rash and fever. .
- Measles vaccine that lost it's potency due to improper storage that may have been used.
- The child immunized may have been too young (before 9 months) and still had many antibodies from the mother.
- The measles vaccine failure rate is 15% and the child may simply be among these.

It is expected that if proper methods and vaccines are used for immunization, the immunity derived is lifelong. There is no point immunizing a child who has already had measles, but to avoid false diagnosis and missed opportunities, request diagnosis to be confirmed by a medical officer. If in doubt, give a dose of the measles vaccine. It does not harm but rather gives added protection.

### ***b) Follow-up***

Measles is the last vaccine to be given to the child. This does not mean the child doesn't need to come to the MCH clinic any more. The mother should keep on bringing him/her on a regular basis, as often as she can (once a month or at least quarterly), for weighing, growth monitoring and any advice, especially on nutrition.

## **Yellow Fever Vaccine**

***a) Yellow fever is a live attenuated freeze-dried, vaccine that must be reconstituted with the diluent provided. The vaccine must be discarded six hours after reconstitution or at the end of the immunization session, whichever comes first.***

### ***b) When should you give it?***

One dose should be given to children at nine months of age or at first contact, at the same time as measles vaccine.

### ***c) When not to give it:***

There are *no contraindications for giving yellow fever to children older than nine months of age. WHO recommends that yellow fever vaccinations should not be given to patients with symptomatic HIV.*

### ***d) How to give it:***

The 0.5 ml dose is given subcutaneously in the upper left arm.

## **Tetanus Toxoid Vaccine (TT)**

It is a relatively heat stable vaccine prepared by formalin treatment of the toxin produced by *Clostridium Tetani* (mainly the Harvard strain).

The most commonly used type of toxoid is the adsorbed one because the antitoxin response reaches higher titres which last longer.

**Note:** The **concentration of toxoid** in the single dose adult preparations is similar to that in the paediatric preparations.

### *a) Why do you give this immunization?*

You give it to prevent tetanus disease, because there is no natural immunity to tetanus. TT is given regardless of age. Pregnant women are immunized so that they provide maternal antibodies to their babies which protect them against neonatal tetanus.

### *b) When not to give it:*

There are *no known contraindications for giving TT vaccine.*

## How to store the vaccine

- Tetanus toxoid should be stored continuously at +2° C to +8° C
- Tetanus toxoid should never be frozen as this reduces its potency
- Tetanus toxoid vaccine that has been exposed to freezing temperatures should never be used.

## How to administer the vaccine

- 0.5 ml of the liquid is drawn into an AD syringe
- Through intra-muscular injection into the **left** upper arm into the deltoid muscle.

## Documentation tools

The main documentation tools are as follows

- The immunization tally sheet
- The permanent TT Register
- The Ante-natal Register
- The injection room register
- The immunization summary sheet

## Common Reactions

Tetanus toxoid is a relatively safe vaccine that rarely provokes severe reactions. The main local reactions are pain, swelling and redness at the injection site but these are usually self limiting and do not require treatment. Should a person develop a severe reaction after being injected with tetanus toxoid, then the next dose must be differed until a qualified medical opinion is obtained.

## OPPORTUNITIES FOR GIVING 5-TETANUS TOXOID VACCINATION SCHEDULE

The aim of the 5-TT schedule is to provide about 20 years + of protection against this killer disease for those at risk and especially for women of childbearing age and their unborn babies.

There are three main opportunities for the administration of the 5-Tetanus Toxoid schedule (5-TT)

### 5-TT FOR FOCUSED ANTENATAL CARE (FANC)

- This is given as part of Focused Antenatal Care – FANC
- Vaccination against tetanus is given during pregnancy episodes
- Doses are documented and when a woman has received 5-doses (usually by the fourth pregnancy) no further doses should be given in subsequent pregnancies.
- After receiving 5 well spaced doses of tetanus toxoid vaccine the woman would have developed immunity for approximately 20 years, and in most cases this is long enough to cover the rest of her reproductive life.

### 5-TT For GIRLS AND WOMEN OF CHILD BEARING AGE (CBAWS)

Tetanus toxoid vaccination is given to females aged between 15 to 49 years **irrespective** of their pregnancy status or reproductive health goals

- The lower and upper age limits can be varied according to local experience of childbearing patterns.
- The lower and upper age limits can be varied according to local experience of childbearing patterns.
- This schedule builds up the immunity of the girl or woman for the assumed eventuality of pregnancy and childbirth for herself and her future babies.

### 5-TT for Trauma and Occupational prophylaxis

- This schedule is usually initiated in the event of trauma and the tetanus toxoid doses should be given in the prescribed intervals until all 5 doses have been given.
- After the five doses, recipients would have acquired immunity against tetanus for 20 years.

### 5-TT schedule for school-aged children

A special programme restricted to the districts of coast province

- Designed for districts having very high prevalence of tetanus infection in neonates and the general community at large.
- The 5 doses of the schedule are administered to all students (males and females) at specified intervals between standard 1 and standard 3.
- On completion of the five doses the children will be protected for 20 years from tetanus i.e. until they are about 29-30 years.



**Fig. 7.3 Health worker administering the vaccine slowly into the mother**

**Note:** Remember to record the immunization in 3 places

- TT Card/Mother's ANC Card
- Permanent TT Register
- Tally Sheet

***g) What happens after immunization***

It may cause a little pain and swelling at the injection site for two or three days.

***IMMUNIZATION REMINDERS: (Reorganize to start with the child)***

- Use every opportunity to immunize Keep vaccines cold at +2 to +8 degrees centigrade at all the time and especially during immunization sessions, particularly OPV and measles.
- Record batch numbers in stock ledger and vaccines and Mother and Child Health Booklet particularly for BCG vaccine..

- Check Vaccine Vial Monitor for potency
- If card is missing, in case of doubt, immunize. An extra dose will do no harm.
- Immunize sick children, unless they are hospitalised. If so, immunize before they are discharged. Give measles vaccine to admitted children on discharge.
- All the vaccines can be given safely the same day first doses as long as they are due.
- Never give expired vaccines. Always check expiry date.
- Use one sterile syringe and one sterile needle per injection.
- Minimum interval between two doses of DPT/HepB+Hib OPV, and TT is 4 weeks.
- Ensure proper documentation on appropriate tools.
- Check immunization status of any pregnant woman and women of child bearing age coming to MCH clinic, whatever the reason.
- Check if the mother knows:
  - *Which vaccine was given;*
  - *Which normal reactions are expected and what to do;*
  - *Next appointment date due*
- Record every vaccine given in the three places:
  - *Mother and Child Health Booklet*
  - *Daily Tally Sheet*
  - *Permanent Registers.*

There is *no maximum time interval* between two doses. Even if a year passes between successive doses of vaccine, do not restart. However remember, interferes with the child is protection.

## EXERCISE

The trainer will set a practical exercise where the trainees practice the different injections on oranges.

Afterwards, they will spend half a day at an MCH/FP clinic to immunize mothers and babies.



# DATA MANAGEMENT, MONITORING AND EVALUATION

## CHAPTER

# 8

### Main objective

The objective of this chapter is to provide guidance to health workers on management and use of routine immunization at the health facility.

Specifically, the chapter describes and explains the following aspects of the immunization program.

- Target-setting and identification denominators of immunization coverage
- Basic indicators used in immunization program
- Sources of information
- Analysis and use of data at health facility level
- Commonly made mistakes
- Standard operating procedures

### Definition of terms used in data management

**Monitoring:** this is a systematic and continuous process of examining processes, procedures and practices within a program. The focus of monitoring is therefore day to day activities within a program with the aim of identifying problems and developing solutions to those.

Because it is a continuous process, data used for monitoring is therefore collected, reported, analyzed and used routinely as defined by the program.

**Evaluation:** this is a periodic assessment of the overall program performance. An evaluation aims to measure the program performance against its objective at specific times.

**Performance:** level of fulfillment of operational capacity of a person or a program.

**Activity:** a task or a set of interrelated tasks aimed at generating a product or a result.

**Indicators:** this is a variable used to compare program performance against its stated objective(s).

## Denominators (targets) of immunization coverage

To be able to conduct monitoring and evaluation process, one must first set the target to be achieved. Two types of targets are set for each facility namely:

- 0-11 months old for (population <1 year old) for primary infant vaccination.
- Pregnant women (expected deliveries) for vaccination with tetanus toxoid.
- Women of Child Bearing Age (for districts considered at high risk of neonatal tetanus) for vaccination with tetanus toxoid<sup>1</sup>.

At the beginning of each year, each facility must calculate the number of children and women to be vaccinated with each antigen. This process is facilitated by the District Health Management Team at a meeting held at the beginning of each year. During this meeting heads of health facilities bring copies of their facility's "Immunization and Vitamin A Summary sheet" for the previous year (12 months). The data is then summarized into divisional immunization data for the previous 12 months and facilities within the division are assigned targets for the New Year based on the current year's divisional population and proportional contribution to the divisional performance during the last 12 months.

Target setting for health facilities is carried out annually during a review meeting organized by the District Health Management Team (DHMT).

## Routine immunization indicators

Indicators are variable used to compare performance in terms of efficiency, effectiveness and results. They:

- Convert raw data into useful information
- Mark progress towards defined targets
- Describe the situation and measure changes over time.
- Provide information about a broad range of conditions through a single measure
- Enable comparisons between different facilities.

A target is a number of an indicator that represents a specific objective to be achieved over a specific period of time.

Indicators usually used in routine immunization are:

---

<sup>1</sup> This classification is done by the national level. If not expressly informed the national program, consider yours district not at high risk.

- Immunization coverage
- Dropout rates
- Completeness &
- Timeliness of reports

### Coverage:

This is a measure of the extent to which the services being rendered cover the potential need for these services in the community. Immunization coverage is the proportion of vaccinated individuals among the target population. It is one of the most important indicators of a successful immunization programme. Coverage is calculated by dividing the number of individuals vaccinated with a particular antigen (numerator) by the number of individuals targeted for vaccination with the antigen (denominator) within the same period. This proportion is then multiplied by 100 to get percentage coverage.

### Coverage formula:

$$\frac{(\text{Number of individuals vaccinated})}{(\text{Number of individuals targeted for vaccination})} \times 100$$

The following coverages are routinely calculated

- Coverage for each vaccine dose.
- Coverage for fully immunized child
- TT2+ coverage

**Example:** During the previous year, health facilities in the Langalanga Health Centre of Nakuru District administered 102 doses of DTP-HepB+HiB3 and 73 doses of measles vaccine to children less than one year of age.

If the number of doses of DTP-HepB+HiB3 immunizations given over the past year is 102 and the target population of children below one year of age in Langalanga Health Centre is 150, then the coverage with DTP3 will be 68%.

$$\text{DTP3 coverage} = \frac{102 \times 100}{150} = 68\%$$

**The measles immunization coverage is calculated in a similar way.**

$$\text{Measles coverage} = \frac{73 \times 100}{150} = 49\%$$

## Dropout Rates (DOR):

Dropout is defined as the number of individuals who start an immunization schedule but fail to get the last dose/antigen on the schedule. For example if a woman brings her child for DTP-Hep-B+Hib1 and OPV1 but does not return for other childhood immunization, her child is considered a “DROP OUT”. Drop out is calculated by subtracting the number of individuals who complete receive the last dose/antigen in the schedule (numerator) and dividing the difference by the number of individuals who started the schedule. For calculating drop out, pentavalent 1 is considered the first vaccine on the schedule and pentavalent3 the last vaccine dose.

Dropout rate for measles (measles-pentavalent1) may also be calculated but the information should be interpreted differently from dropout for pentavalent.

Dropout rate formula: 
$$\frac{(\text{Doses of DTP-HepB+Hib-1} \text{ minus Doses of DTP/HepB+Hib-3}) \times 100}{(\text{Doses of DTP/HepB+Hib-1})}$$

**Example:** During the previous year, Kamwaura Dispensary in Nakuru District administered up to the month of August 91 doses of DTP1, and 76 doses of DTP3 to children less than 1 year of age. The drop-out rate for Kamwaura Dispensary is as follows:

$$\text{DTP-HepB+Hib-1 - DTP/HepB+Hib-3 drop-out rate} = \frac{(91-76) \times 100}{91} = 16\%$$

## Completeness

Completeness of the reporting is defined in two different ways depending on the level and function of reporting unit.

- i. At a health facility level, completeness means that all required fields in a report have been filled. How well this is done determines the quality of data being reported.
- ii. At district and subsequent levels, completeness of reporting for the particular period is defined as the proportion of reports received. This is calculated by dividing the total number of reports received from the reporting units (numerator) by the total number of reporting units (denominator). The result is then multiplied by 100 to make it a percentage.

Completeness formula: 
$$\frac{\text{Total reports received}}{\text{Total expected reports}} \times 100$$

The health worker should ensure that all monthly reports are sent to the district. Non-reporting of late data affects the overall district coverage and, subsequently, the national immunization coverage.

## Timeliness

Timeliness of health reporting is defined as a proportion of reports that are received on time. It is the number of reports received on time divided (numerator) by the total number of reports expected for the period (denominator)

Formula for timeliness:  $\frac{\text{Total reports received on time}}{\text{Total reports expected}} \times 100$

Data collected from the tally sheets needs to be summarized, for action at health facility level and transmitted to the district level by 5th of the following month. The districts then uploads the data on the DHIS website

When reports are sent and received on time, the possibility of a prompt and effective response is greater. Late data should not be ignored; they must be sent to the district level to up-date the existing data set at all levels. Not reporting late data affects the overall district coverage and, subsequently, the national immunization coverage. Late reports should be sent together with the next monthly report with explanatory note specifying the month of the data.

## Collecting routine immunization data

All immunizations must be accurately recorded at the health facility. This will allow accurate calculations of coverage for different antigens as well as assist in defaulter tracing where necessary. To monitor immunization activities well the following tool should be available at each immunizing facility:

- Mother and Child Health Booklets
- Immunization tally sheets
- Immunization Permanent Register
- Immunization and Vitamin A Summary Sheet
- TT Permanent Register
- Tracking system to monitor defaulters
- Immunization Monitoring Chart

## Mother and Child Health Book

This is the child's/woman's individual immunization record. It is kept by the caregiver and therefore is the only immunization record that is found in the community. This card is brought to the clinic during each visit.

In addition to the demographic information about the child/woman, the following information is recorded in the card:

- The type of vaccine and dose number
- The date the vaccine was given
- The date of the next appointment
- Any adverse event that may have occurred during a previous vaccination
- An immunization card serves the following purposes
- Reminds the caregiver when to return to the clinic
- Assists the MCH staff to ascertain the immunization status of the child/woman
- Allows continuity of service when the child/woman moves to another area.
- During coverage surveys, the card is used to verify immunization status of the child/woman.

### **Immunizations and Vitamin A Tally Sheet**

This is daily record of immunization activities at a health facility. Each vaccine and dose number is recorded appropriately immediately it is administered. The procedure for filling the immunization tally sheet is as follows:

- First write the name of the health institution, the name of the district and the date on which you start the sheet.
- For each immunization you perform, strike the printed zero vertically at the correct line, according to the type of immunization given and the age group of the child.
- On the last line, “Number of Children Immunized” you strike a zero for each child that has completed the immunization schedule. At the end of each day, draw a vertical line across the paper in front of the last 5 zero batch that you have marked.
- On the top line, enter the date during which those immunizations were performed.
- Continue using this sheet until it is full, or until you expect that entries for the next immunization clinic will exceed the numbers of zeros left.

### **Immunization and Vitamin A Summary Sheets**

An immunization summary sheet is a summary of monthly immunizations given at health facility. It is completed by summarizing the data from the daily tally sheets for a particular month.

- Fill in the month and name of the health facility.

- Each day, when you finish your MCH clinic, draw a vertical line on the immunization tally sheet and count the number of immunization recorded on the tally sheet.
- Enter the totals on the summary sheet. Each column on the sheet represents 1 day of the month, the first line being the first day of the month up to the last date of the month.
- Make sure that you enter the totals from the Immunization Tally Sheet in the correct column; on the day the immunizations were given. This will make your work easier because your monthly report will be compiled daily.
- When you have filled in the daily entries for a whole month, sum up each row, and enter the totals on the rows written “total” on the right side of the sheet.
- Compare it to your target, present it on a monitoring chart and discuss it with the team.
- Send the summary sheet within 5 days after the month ends to the District Public Health Nurse and remember to put the date and your name in the space provided at the bottom. \*

**\*NB.** The health worker should ensure that all fields in the Monthly Immunization Summary Sheet are filled appropriately before sending to the district level.

## Immunization Permanent Register

This is the permanent record of individual immunization history at the health facility. Each row represents a single child while each column represents an antigen. Detailed instructions on how to complete the permanent register are at the back of the cover page. They are summarized as follows:

- When a child is brought for the first time for immunization, register the child in the large hardcover (register) provided. For ease of follow-up and easy retrieval of the child’s records, the number appearing in the child’s immunization card should be the same as in the register.
- Every time the child is presented for immunization, you will record the date and vaccine(s) given in the register under the child’s number. Note the child should appear only once in the register.
- Once a month, you should go through the register and find the children who should have been immunized that month and were not.
- Get in contact with the parents and request that they bring the children to the clinic. The community health worker or a public health technician can do this.
- It is only by your active follow-up that all children in your catchment area will be fully immunized.

At every visit to the health facility, the child should be screened for immunization status and all due vaccines administered. Every antigen given to at every visit should be:

- Recorded on the Permanent register
- Recorded on the Mother and Child Health Booklet
- Talled on the immunization tally sheet

### **TT Permanent Register**

Just like the immunization permanent register; this is a permanent record of a woman's immunization with tetanus toxoid. It is completed as follows;

- When a pregnant woman visits the health facility for the first time, register her in the hardcover hook (register) provided. For ease of follow-up and easy retrieval of the woman's records, the number appearing in the register should be the same as the one in the TT or ante-natal card.
- Each time the expectant mother comes for TT immunization, you will record the date and vaccine given in the register under her number. Note that woman should appear only once in the register.
- Once a month, you should go through the register and find the pregnant women who should have been immunized that month and were not.
- You should get in contact with them and advise them to come for immunization.

NB. Each time you administer immunizations, record them in three areas i.e. TT antenatal card, tally sheet and the permanent Register

### **Tracking systems to monitor defaulters**

A child is defined as a defaulter once he/she fails to turn up for immunization at least 2 weeks after the appointment date. Each facility should compile a list of defaulters at least once a month and efforts to trace them be made. There are several methods to track defaulters that can be adopted. They include:

- Use of permanent registers
- Use of immunization diary
- Use of tickler cards.



## Immunization Monitoring Chart

An immunization monitoring chart is a graphical presentation of a facility's performance. It is plotted monthly using data from the monthly immunization summary sheet. Cumulative data for selected antigen representing key aspects of the immunization program are plotted and monitored monthly and compared with the targeted coverage. To complete the monitoring chart, the data required include: total population of the catchment area, target population; number vaccinated with the specific antigens and number of cases of certain vaccine preventable diseases.

**Fig 8.2 How to prepare Immunization Monitor Chart**

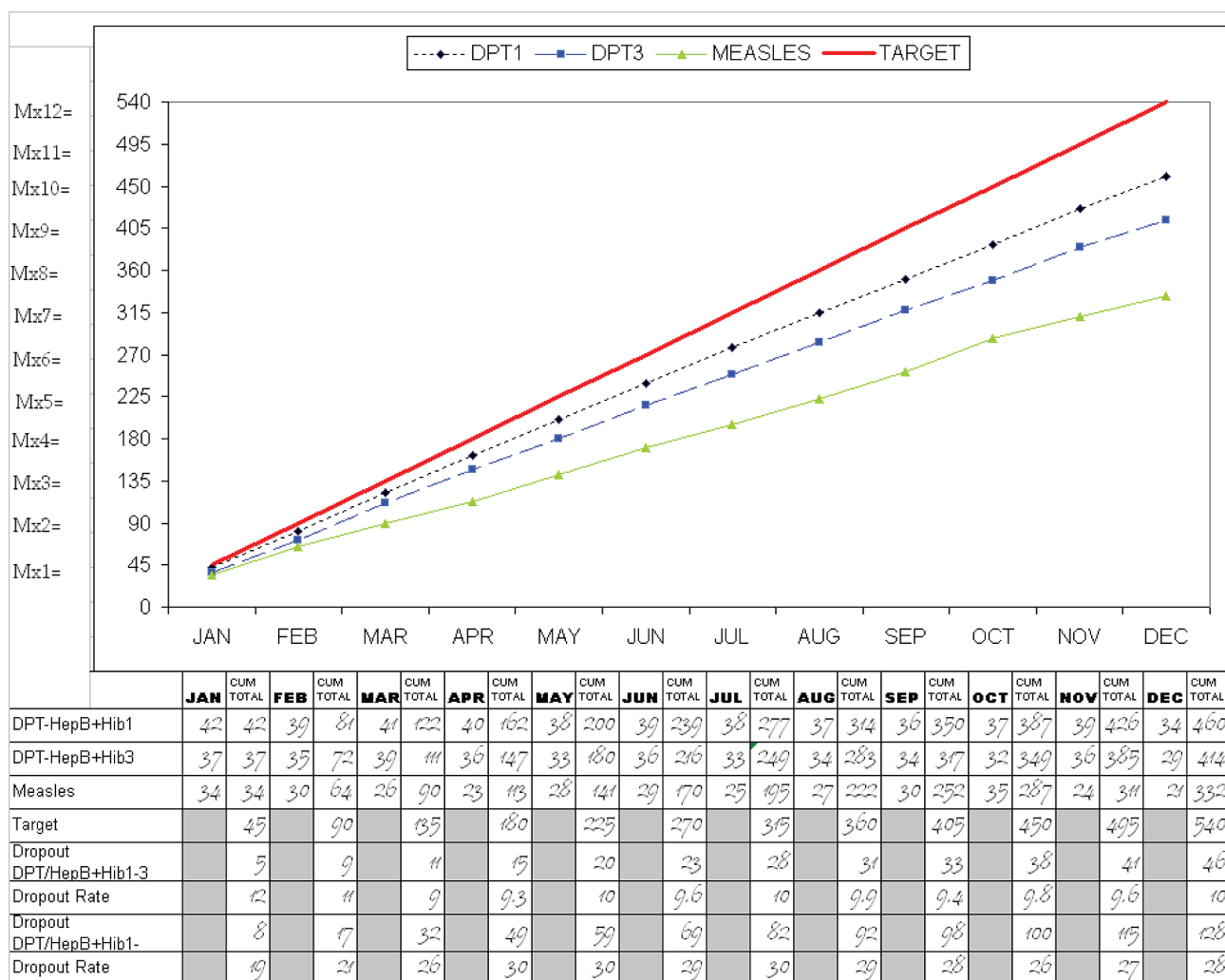

1. Write the name of health facility.
2. Fill in the total population for your catchment area.
3. Fill in the annual target populations for children below 1 year
4. Fill in the monthly target populations for immunization by dividing the number of children below one year of age by 12.

5. Fill in the cumulative monthly targets
6. At the end of each month, enter the total number of immunizations given then add the present month's total to the previous cumulative total.
7. Plot on graph the cumulative totals by marking on the right side of the month column you are recording. Draw a line between the new dot and the previous month's dot.
8. Subtract the cumulative total for DTP-HepB+Hib1 from the cumulative total for DTP-HepB+Hib3/Measles. This is the cumulative total number of drop-outs for this period of the year.
9. Calculate the cumulative drop-out rate (DOR).
10. Enter the number of cases of the target diseases seen in the health facility into the appropriate section of the monitoring chart
11. If no case was reported enter 0 (zero reporting)

**Cumulative total:** the total number of doses of vaccines given in the current month plus the monthly totals for the previous months.

**Example:** the cumulative number of DTP-HepB+Hib1 doses given by the end of March is the total number of doses given in January plus the total number given in February plus the total number given in March.

### Analysis and use of data at health facility level

After data has been summarized from the tally sheet to the monthly summary sheet, the information used to identify existing problems at health facility level. This allows the health facility to determine the causes of each problem and possible solutions. At a health facility, problems can be categorised a problem of access, utilization or both.

Access is defined as the proportion of children who are reached with immunization services. It is measured using coverage for pentavalent 1 and can either be describe as good ( $\geq 80\%$ ) or poor ( $<80\%$ ).

Utilization is the ability of a healthy facility to retain the children accessed till they receive the last dose on the schedule. It is measured using the dropout rate between pentavalent 1 and pentavalent 3(or measles). It can either be low ( $<10\%$ ) or high ( $\geq 10\%$ ). Using the defined cut-off for access and utilization, an algorithm is used assign the facility to a problem category as shown in the flow chart below:

Figure 8.3 EPI access and utilization algorithm

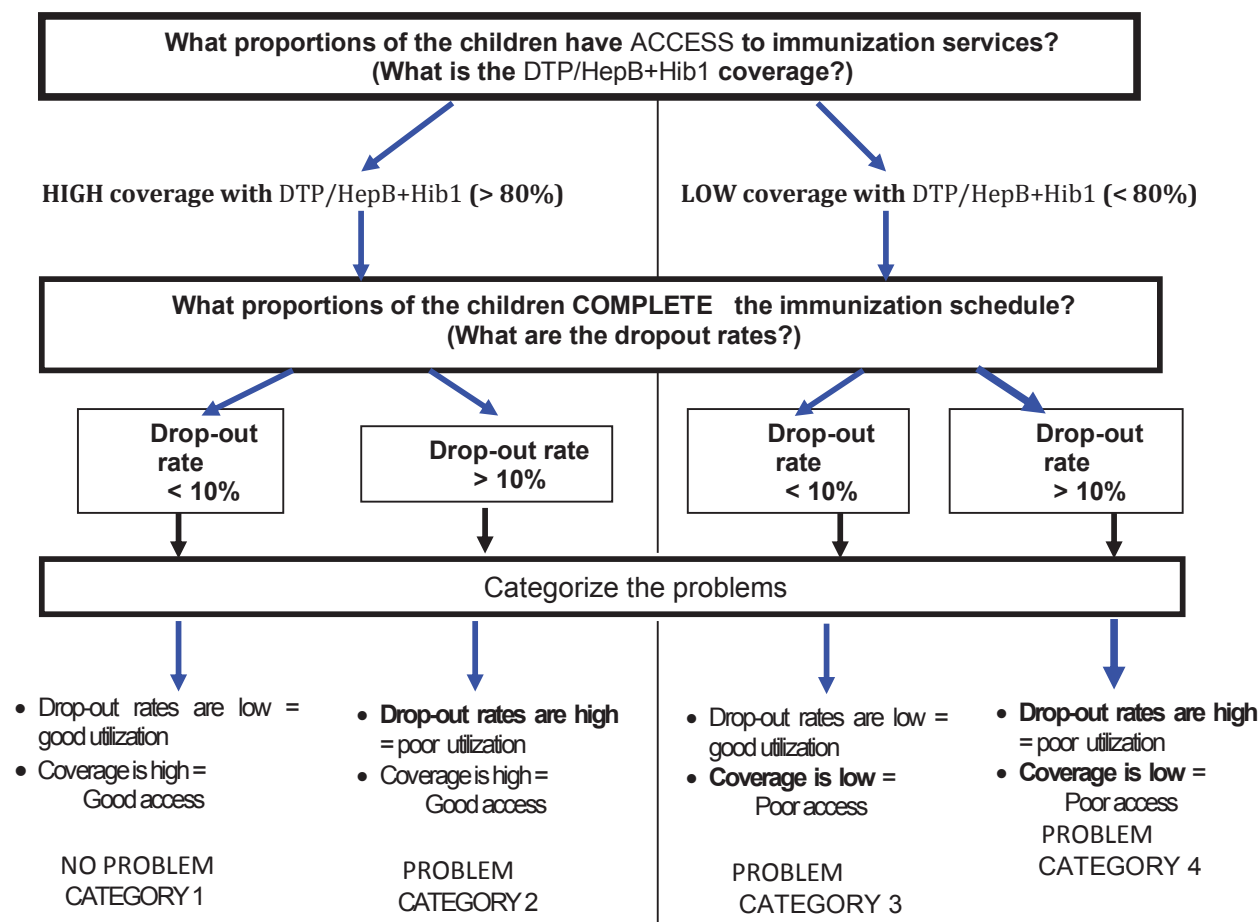

Low coverage (<80%) may be caused by the following:

- Inaccessibility (geographical, other barriers) – in this case the children and women are not reached at all or do not utilize the services
- Drop-outs – this group starts immunization but does not return to complete the schedule. Dropout is a major obstacle to achieving KEPI coverage objectives. To reduce dropout rates, health workers should know the extent of the dropout rate problem in their facility catchment area. A Dropout rate less than 10% or less demonstrates good utilization of services. Dropout rate higher than 10% indicates problem with utilization of services. It is therefore necessary to routinely monitor the trends of coverage and dropout rates in order to ensure timely action aimed at reaching every child.
- Missed opportunities – in this group children and women have had contact with health worker for any other reason – for example, a woman bringing her child suffering from diarrhoea – but both she and her child were not screened for immunization status and were not immunized by the health worker.

- Lack of awareness of immunization services or rejection of vaccination due to socio-cultural reasons.

Poor utilization (high dropout) of immunization services may be caused by:

- Irregular supply of vaccines
- High workload for staff
- Poor staff attitude
- Poor scheduling of immunization sessions.

To identify the causes of the problems you should hold discussions with the community and health staff. For promoting completion of the full immunization schedule, include community members by asking them how the service can be made more accessible to them. In addition, health staff should discuss why children do not begin or complete the immunization schedule. Exit interviews and observations during sessions by the supervisor provide important hints too.

For each problem, there are many possible solutions. Examples of solutions include:

- Improved communication with the community
- Mobilization of additional resources
- Use of other immunization strategies e.g. outreach, local immunization days etc.
- Scheduling immunization sessions in consultation with the community
- Proper forecasting of the vaccines requirements

### **Standard operating procedures**

Each immunizing health facility should observe the following requirements:

- Calculate and display the its catchment area population
- Calculate and display its target population (<1 year)
- Display a map for catchment population indicating hard to reach areas & special populations
- File and store used tally sheets and summary sheets by month and year for at least 3 years
- Send immunization summary reports to the district by 5th of the following month.
- Regularly Update the district with late reports
- Have an up-to-date immunization monitor chart on displayed on the wall
- Have a mechanism in place to track defaulters
- Establish linkage with the community

## Other methods for evaluating immunization programme

Apart the data collected routinely (administrative data), there are other methods used periodically to assess the performance of the immunization program. These are usually conducted by a team with certain expertise and at a pre-determined interval and require a lot of planning and hence they are expensive. The commonest methods used are:

### Data Quality Self -Assessment (DQS)

The Data Quality Self-assessment (DQS) is a flexible methods used to evaluate different aspects of the immunization monitoring system at district and health facility levels. The DQS aims to determine:

- the accuracy of reported figures for coverage (i.e. number of immunizations) and for any other immunization system indicator
- the quality of any component of the immunization monitoring system

The assessment includes a review of data accuracy at different levels and a self-designed questionnaire reviewing monitoring quality issues (e.g. availability of vaccination cards, use of tally sheets, directly-observed recording and reporting practices). Data are then analyzed, with a view to identifying strengths and weaknesses which need to be correct.

### Immunization Survey

An immunization coverage survey examines a small number of individuals to determine their immunization status. It involves visiting homes, examining immunization records and asking the individual, parent or caretaker about immunizations received. This is done in a systematic way so that only a small sample of homes and individuals need to be surveyed in order to obtain valid results that can be generalized to the larger population. The coverage survey will inform about the following issues.

- Infant immunization i.e. how well facilities have met their target for immunizing infants. This is important because if a child does not receive the recommended immunizations as early as possible he/she will not receive the maximum protection from vaccine-preventable diseases
- Tetanus toxoid immunization for women i.e whether mothers of infants have been immunized with tetanus toxoid (TT).
- Reasons for immunization failure i.e. why people do not come or return for immunization. This is important because it will help in finding ways to increase your immunization coverage.

A coverage survey can validate the results of routine reports and provide additional information.

An advantage of a coverage survey is that it tells how many people were immunized correctly, as well as how many were immunized by other providers. It also can provide important information on true coverage in situations where of target children is not known. The most famous EPI coverage survey is the 30x7 cluster survey where 30 clusters are systematically selected and 7 eligible children are evaluated for their immunization status. This gives a total of 210 children in the survey. There are other variations of the survey but they all use the same principles of cluster survey.

## Post-Introduction Evaluations

This is a periodic survey to evaluate the impact of introducing a new vaccine on the existing programme. It involves assessing various aspects of the programme: The main areas assessed include (but not limited to) the following.

- Pre-implementation Planning and Training
- Coverage and Reporting
- Cold Chain and Vaccine Management
- Waste Management, Injection Safety and AEFI
- Health Care Worker (HCW) Knowledge, Monitoring and Supervision
- Advocacy Communication and Acceptance

Post-introduction evaluation usually involves many agencies and is conducted after at-least 6 months after a new vaccine is introduced.

# DISEASE SURVEILLANCE

## Learning Objectives

By the end of the session, the learner should be able to:

1. Define the term disease surveillance
2. Outline types of disease surveillance
3. Describe steps in EPI disease surveillance
4. Describe steps in investigation for the three EPI target diseases
5. Detect, investigate, report and respond to outbreaks of the three EPI target diseases

## What is disease surveillance?

Disease surveillance is the collection, analysis, and interpretation of data to determine disease trends and patterns. Disease surveillance provides information such as:

- Disease incidence, morbidity, and mortality, and progress in achieving disease control goals
- Changes in patterns of morbidity and mortality among different age groups in different geographical areas and among different economic, social, or cultural groups
- Impact of immunization strategies on disease incidence
- Disease trends

The overriding value of disease surveillance, however, is its use as a tool to identify the presence of infectious diseases and guide actions to prevent them from becoming threats to public health.

This chapter describes the activities required to carry out that function.

## Types of Disease Surveillance

**Facility-Based Routine Surveillance**- health workers are required to report on the number of individuals that come to their facility and are diagnosed with notifiable diseases. The process of detecting and reporting information on diseases that bring patients to the health facility is known as passive surveillance eg MOH 719.

**Community-Based Surveillance** - With proper training, members of the community can expand facility-based surveillance by detecting and reporting cases that may go undetected by the health facility.

**Sentinel Surveillance** - Sentinel surveillance is the collection and analysis of data by designated institutions selected for their geographic location, medical specialty, and ability to accurately diagnose and report high quality data.

## Surveillance Activities

Surveillance for communicable diseases involves:

- Detection
- Investigation
- Reporting
- Analysis and interpretation
- Presentation
- Response

## Detection

Surveillance begins with case detection. To accurately detect disease, health workers need case definitions that are appropriate for the local context, and they need practice in applying them, especially when they do not see a specific illness very often such as is the case of Polio. Even with appropriate case definitions, clinical diagnoses can be a problem. Many illnesses have similar symptoms, such as fever and rash, and can be differentiated only by laboratory tests that may not be accessible.

Each facility should have a disease surveillance focal person who should co-ordinate through availing the specimen collection tools, carry out Active Case Search and communicate to the District Disease Surveillance Co-ordinator (DDSC).



## Investigation and Reporting

Ministry of health through HMIS require that facilities routinely report the total count of cases of each reportable disease that has occurred within a specified time usually monthly in the MOH 719. When no cases have occurred during the period, the report should indicate this fact (Zero report). For EPI target diseases reporting is case based i.e each case should be reported individually using the IDSR form.

Fig 9.1 Surveillance and Data Flow

### Surveillance and Data Flow Summary



## Analysis and Interpretation

Surveillance data are of little use for local decision-making and planning unless health workers know how to analyze the data and understand their implications. Health workers need to be able to interpret trends and patterns of disease in order to enact prompt control measures and avoid actions that are not appropriate. In order to analyze and interpret surveillance data, health workers need to be aware of the limitations and peculiarities of the data set. Presentations can be done using graphs, tables, maps etc. An example is shown on the next page.

Fig 9.2 Graph of Disease Surveillance Throughout The Year

**Number of Laboratory-Confirmed Measles Cases by Month of Onset, January 2002 – August 2003, Kenya**

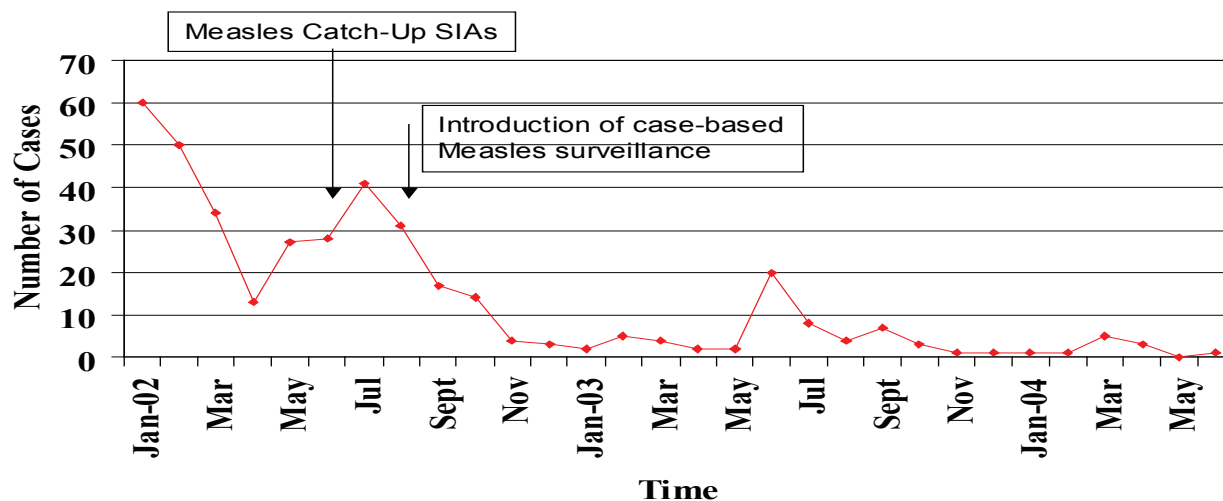

Disease surveillance enables managers to respond to existing problems and take steps to prevent anticipated problems. Responses may include verification of reported cases, treatment, search for new cases, or supplemental vaccination activities, but all must be tailored to the disease and the situation.

### PRACTICE EXERCISE

**Field Exercise:** To identify, record and summarize cases of priority diseases seen in a health facility. This is a practical exercise (field exercise) to ensure that you have acquired appropriate knowledge and skills in detection and reporting of priority diseases. This will be conducted in an out-patient department of the nearest busy health facility that offers integrated health services (for example a health centre or district hospital)

#### Tasks

- The **clinical practitioners** in the group should work alongside their colleagues and assist them in making diagnosis by using standard case definitions provided in the **Technical guidelines** (refer pages 23 to 28 and 197 to 206)
- You should go through the outpatient register and **select new cases of priority diseases** that need reporting to the next level

- Identify about **20** such **new cases** and summarize (line list) them
- Each group should summarize the strengths and weaknesses of the surveillance system in the health facility
- Groups should make recommendation on how to improve the surveillance system

## Feedback

- Each group should present their findings and recommendations in the plenary

## NOTES

### Standard Case Definitions for EPI targeted diseases

Ministry of Health targets nineteen notifiable diseases. (*Refer to IDSR Guideline August 2004*). However this chapter will concentrate on EPI diseases only. KEPI currently targets three diseases (Polio (AFP), Measles and Neonatal Tetanus (NNT) with active surveillance activities.

#### *Epidemic-Prone Diseases*

- Measles
- Yellow Fever

#### *Diseases Targeted for Eradication*

- Acute flaccid paralysis (AFP)/polio

#### *Diseases Targeted for Elimination*

- Neonatal tetanus
- Measles

**Measles** - Any person with fever and maculo-papular generalized rash and cough, coryza or conjunctivitis (red eyes) or any person in whom a clinician suspects measles. A measles death is a death occurring within 30 days of onset of the rash.

**Acute flaccid paralysis (AFP)/polio** - Weakness or floppiness of sudden onset, not due to trauma, in a child less than 15 years of age or in any case in which a clinician suspects polio

**Neonatal tetanus** - Normal suck & cry for the first 2 days of life+ Onset of illness between 3 & 28 days of age + Inability to suck followed by stiffness and/or convulsions

**Yellow fever** - Any person with sudden onset of high fever (>39C rectal or 38C axillary), followed

by jaundice within two weeks of onset of first symptoms.

### *Simplified messages for use in community surveillance*

Inform community health workers, traditional healers, birth attendants, health workers who conduct outreach activities in hard-to-reach areas, and community leaders about the priority diseases and conditions under surveillance in your area. Use simplified messages such as the following to help the community to recognize when a person with these signs should be referred to the health facility.

### *Simplified community messages*

**Acute flaccid paralysis** Any acute paralytic disease

**Measles** Any person with fever and rash

**Neonatal tetanus** Any newborn who is normal at birth, and then after 2 days, becomes unable to suck or feed.

**AFP (POLIO) SURVEILLANCE - Weakness or floppiness of sudden onset, not due to trauma, in a child less than 15 years of age or in any case in which a clinician suspects polio**



**Fig 9.3 Paralytic Polio**

## **Current Situation**

Polio eradication initiative has been implemented in Kenya since 1996. The last case of confirmed polio was in 1984, and since then intensified surveillance to detect, report and investigate all AFP cases has been on-going. Kenya attained all the required indicators in 2003 and 2004. However

these gains are at the national level but we still have districts and provinces who have not attained all the required indicators. This calls for more action from the facility level in terms of stool adequacy and investigation of all AFP cases within 14 days of paralysis onset.

### **Acute Flaccid Paralysis (AFP)**

Acute: rapid progression of paralysis, <2-3 days (from onset to maximum paralysis)

Flaccid: loss of muscle tone, “floppy” (as opposed to spastic or rigid)

Paralysis: weakness, loss or diminution of motion

## **Epidemiology of Poliovirus**

### **Characteristics**

- Member of enterovirus family
- 3 virus types:
  - Type 1*: most typically causes outbreaks
  - Type 2*: easiest to eradicate
  - Type 3*: circulation is more geographically confined
- Highly contagious - usually infects 100% of all susceptibles
- Occurs worldwide, seasonal - hot, humid months
- Inapparent (No signs) to apparent (signs and symptoms) infection ratio = 200:1

### **Transmission**

- Fecal – oral route most common
- Infection to onset of paralysis: 10 – 21 days
- Rapid spread
- Most poliovirus excretion just before paralysis and within first 2 weeks of onset
- Excretion in some patients may occur for up to 2 months

### **Immunity**

- By immunization or natural infection
- Immunity to one type does not protect against other types

- Passive immunity from mother lasts several weeks in baby
- Believed to be life long by natural infection or OPV
- Optimal protection requires 3 or more doses of OPV

**Fig 9.4 Clinical Spectrum of Poliovirus Infection**

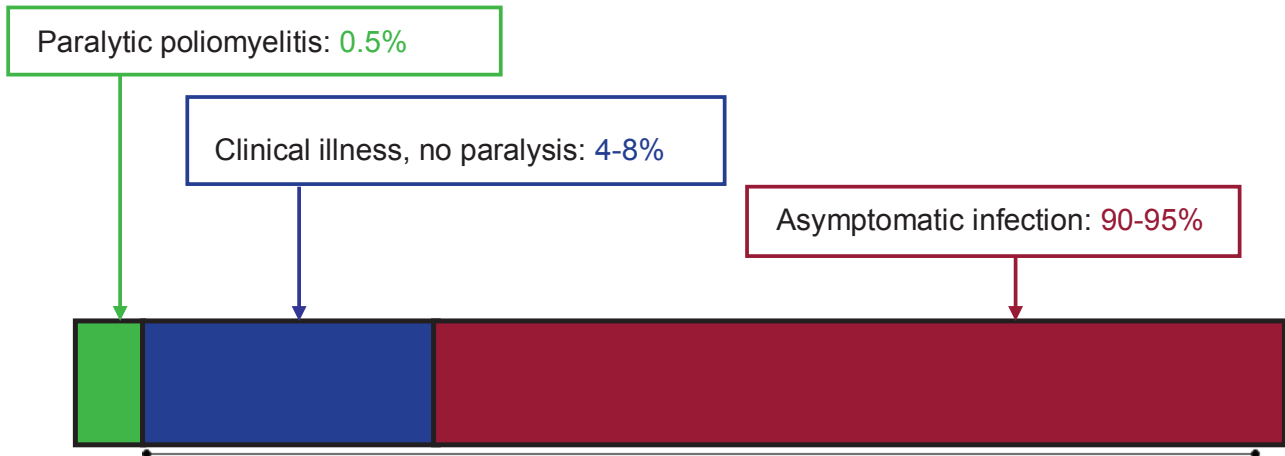

# MAXIMIZING OPPORTUNITIES, COMMUNITY LINKAGES, AND COMMUNICATION

## CHAPTER 10

### Overall objective

To describe how to link services with communities and what roles can be successfully undertaken by community representatives and health workers to improve organization, management and communication on services.

### Objectives

- To describe the role of an immunization programme to the public.
- To identify reasons for low community participation in immunization and how to address these.
- To suggest ways of increasing target groups and the best ways to reaching them, and to formulate specific messages.

### Why do we need the public's participation?

It is not enough to develop and maintain good physical and material infrastructure for immunization and ensure that services are available and reliable; communities must also be aware of, accept, trust, value and utilize these services. The ultimate objective of these services is to raise and sustain immunization coverage for the target groups and reduce the vaccine preventable diseases. If the public participate in our programme, they can help us to inform and convince caregivers about immunization and assist with mobilization and organization of services such as outreach.

### Maximizing opportunities for immunization

To achieve higher coverage and a significant reduction of drop-out rates, community participation is indispensable. However, KEPI and other KAP studies have shown that even some people who have access to services do not use them because of lack of adequate or correct information or mistrust or lack of confidence in the service. People cannot participate in what they do not know, believe in or accept. Hence, the need to inform families and communities of the potential

benefits of immunization, the safety of vaccines, and where and when services can be accessed. Health workers must be knowledgeable and skilled in communicating with service users. At minimum, every adult who leaves a place of immunization should know what immunization(s) the child has just received, the possibility of side effects and what to do if they arise, and when and where the child has to return for the next immunization. In addition, the health worker should encourage the caregivers to make a return visit according to schedule and ensure that the services are available.

## Understanding barriers to immunization

It is important to understand potential barriers to immunization to be able to adapt services and design community and communication interventions appropriately. Following are some of the barriers faced by the immunization programme:

Immunization systems related reasons/factors	Communication and information related reasons/factors	Family or societal characteristics	Parental attitudes and knowledge
<ul style="list-style-type: none"> <li>• Access/Distance to services (rural and/or remote communities with no/irregular outreach)</li> <li>• Living in rural area</li> <li>• Unavailability of supplies/vaccines</li> <li>• Poor health worker knowledge and training</li> <li>• Poor service quality and reliability</li> <li>• Lack of antenatal/perinatal care</li> <li>• Missed opportunities (including not having vaccination card at the time of the clinic visit, vaccinator absent at the designated time of immunization services, and children receiving curative services only (i.e. the child's immunization status is not assessed))</li> <li>• Living in urban area (duration of travel time in an urban setting)</li> <li>• Living in settlement/slum area</li> <li>• Lack of physician referral to services</li> <li>• Cost of vaccinations</li> <li>• Poor timing/availability of vaccinators</li> <li>• Vaccination schedule</li> <li>• Weak and inadequate supervision at the local and district level</li> </ul>	<ul style="list-style-type: none"> <li>• Lack of health educators</li> <li>• Poor communication from health worker (perceived provider rudeness or a lack of trust in him/her)</li> <li>• Lack of information on vaccination schedule, when child is due, where to receive vaccinations</li> <li>• Inadequate media messages</li> <li>• Dissemination of inadequate or incorrect information by health care worker</li> <li>• Lack of media exposure</li> <li>• Lack of community involvement</li> <li>• Gender of health worker</li> <li>• Lack of trust or social connections</li> <li>• Lack of home visits by health worker</li> </ul>	<ul style="list-style-type: none"> <li>• Illiterate caregivers</li> <li>• Low education level of caregivers</li> <li>• Low socioeconomic status</li> <li>• Living in a large family/having older siblings</li> <li>• Belonging to minority group</li> <li>• Migrants</li> <li>• Blue collar worker/occupation</li> <li>• Marital status - mom unmarried</li> <li>• Male headed household</li> <li>• Mother's age</li> <li>• Other domestic issues (conflict/death)</li> </ul>	<ul style="list-style-type: none"> <li>• Caregivers' lack of knowledge about immunizations</li> <li>• Motivation</li> <li>• No understanding of vaccine importance (Caregivers frequently not aware of the need to vaccinate their child or the threat of disease transmission if their child was not vaccinated).</li> <li>• No information on when to vaccinate</li> <li>• Misconception of vaccinations (ranging from the impression that vaccinations do not work to the concerns that vaccinations harm the child, or cause disease or other adverse event such as sterility).</li> <li>• Fear of side effects</li> <li>• Fear of vaccination</li> <li>• Being female child</li> <li>• Religious/cultural/traditional beliefs against vaccines</li> <li>• Lack of family discussions on vaccines</li> <li>• Reject vaccinations - no reason</li> <li>• Mother's autonomy</li> <li>• Previous bad experience with clinic</li> <li>• Social pressure against vaccinations</li> <li>• Contraindications to vaccinations incorrectly interpreted; and children for whom vaccinations were otherwise appropriate are not vaccinated.</li> </ul>



## Addressing barriers to immunization and ensuring service delivery and utilization

Utilize your immunization coverage data (registers, monitoring charts, tally sheets, etc.) and other study data (e.g. KAP, focus groups, programme reviews) to determine where you have access (low penta1) and/or utilization (low penta3) problems. Refer to Chapter 9 on how to analyse and use these data. Based on this analysis, you should determine which barriers apply to your programme, update your microplan, and adapt your services to address these barriers, in collaboration with the community. Although barriers will vary and your strategy should be adapted based on the situation at your facility, following are some possible suggestions to maximize availability and utilization of services:

### *Lack of time to come for services*

- *Timing of session* might be improper: avoid closing the MCH clinics in the afternoons. Remember immunization services are from Monday to Friday 8 am to 5 pm.
- Avoid (or choose) market days, depending on the suitability within the locality.
- If you plan a weekly session or a monthly outreach session, come on the same day at the same time: it will be easier for everybody to remember (and if this needs to be adjusted, plan with the community and communicate any changes well in advance – *if you miss sessions, community confidence will reduce*)

### *Problems of distance and transportation*

- If the distance is greater than 5 km, plan advance or outreach strategies and communicate the dates, locations, and times beforehand. Be sure that that these sessions are not missed or that if there are delays or rescheduling, communities are notified promptly. (Failure to conduct outreach as planned will result in drop-outs and lower coverage.)
- If mothers have major problems of transportation, be sure not to miss any opportunity to immunize a child. They might not be able to come back another time. Reorganize outreach sessions, planned with the communities, to hold them closer to the community on the appropriate days/times.

### *Long waiting time*

- If immunization is offered daily, from 8 am to 5 pm, waiting time will be decreased.
- Follow a first come, first serve basis to reduce waiting time (and do not wait for quorum to begin vaccinating).
- Make this waiting time both pleasant (by providing shade, seats, fresh water) and useful (by giving health education).

- Organise shifts of staff for lunch and tea breaks so that services are available all day.

### *Attitude of staff*

- Be polite and friendly, even if you are tired.
- Remember, immunization decreases diseases and thus decreases your work, so do not be impatient with caregivers.
- Immunize daily from 8 a.m. to 5 p.m., you will have fewer children at a time and this will give you more time to talk to the mothers.
- Seek the help of community members.

### *Lack of organisation of services*

- Address service delivery problems (and seek assistance from communities, if needed): Ensure adequate stock of vaccines and injection material, be sure equipment is in working order and fix broken equipment, ensure supply of gas and transport, conduct fixed and outreach sessions as planned, utilize monitoring tools (including availability of Mother and Child Health Booklets).
- Mother not told to return for subsequent dose: always give a return date and write it in the Mother and Child Health Booklet and confirm with her that she understands.
- No card provided by the mother; don't send her away. According to the child's age and the mother's memory, you should still vaccinate and record it on a piece of paper. Remember, *an extra dose of vaccine will not do harm. A missed opportunity might make the child at risk of these diseases.* Remind the mother to keep and protect the Mother and Child Health Booklet and bring it every time she comes. Ask her if she has any questions on the content of the Card.

### *Bad experience with previous immunization*

- Painful injection or reaction: make sure proper injection and immunization safety techniques are followed and communicate what to do if there is a reaction (e.g. swelling or abscess).
- Unexpected *side effects* frighten the mother: counsel the caregiver - always explain the possible side effects and reassure the mother that these effects are minor and usually resolve themselves quickly (and that the risk from the disease is much more severe if the child is unvaccinated). Tell the mother what to do if a severe reaction occurs.

## *Negative attitudes and beliefs*

Identify traditional beliefs which are against or question immunization or health services and negotiate with the traditional and other leaders to change attitudes and ensure acceptance of services.

- Where people are not convinced that immunization protects the child or mother, health workers should explain the greater risk of contracting and spreading these diseases and becoming sick or dying if the child or mother is unimmunized.
- Negative attitudes of head of village or family should be handled through dialogue with them involving convinced heads, friends or groups.
- Negative attitudes of health workers towards the immunization programme and clients should be discussed; try to come up with a positive approach with individuals and at meetings.
- Negative attitudes of traditional practitioners can be solved by enlisting their support and educating them.
- Organise seminars/workshops with local leaders and invite them to participate and contribute towards achieving better health for the people.

## *Missed Opportunities*

A missed opportunity for immunization occurs when any eligible child or woman comes to a health facility and does not receive any or all of the vaccine doses for which he or she is eligible. The opportunity to immunize eligible children is missed when the:

- health facility does not offer immunization services
- health facility is experiencing vaccine stock-out
- health workers do not use appropriate contraindications to immunizations
- health workers do not routinely screen children and women for their immunization status and offer the recommended vaccines
- health workers do not give all the vaccines for which the children and women are eligible at the time of the visit.
- health worker decides to schedule certain vaccines for fear of running out of vaccines or a high vaccine wastage (multi-dose lyophilised vaccines)

Missed opportunity surveys or rapid situational assessments provide health workers with information that may be used to reduce the number of missed opportunities and increase the number of people reached with immunizations. Missed opportunity surveys that have been conducted in

various districts in Kenya indicate that the major causes of missed opportunities are the use of false contraindications by health workers and poor planning of immunization sessions.

**Ways to reduce missed opportunities:**

- Conduct periodic surveys to measure missed opportunities
- Identify missed opportunities by examining health facility records and immunization cards (Child Health and Antenatal Cards)
- Check immunization status of every child 0-23 months and pregnant women visiting health facilities or coming to the outreach site for any reason. Those in need should be immunized before leaving
- Avoid false contraindications to immunization e.g. fever, cold, diarrhoea, vomiting and malnutrition. Incorrect use of contraindications denies life-saving immunizations to many infants (see summary box)
- Ensure that all eligible women and children have an immunization card and that they bring the card to every clinic visit and that these cards are checked by the health worker on every visit and the relevant details discussed with the mother
- Ensure that those sick enough to be admitted are immunized on admission or before discharge from hospitals
- Avoid scheduling of vaccination services and inconsistent outreaches
- Encourage health workers to open a multi-dose vial of a lyophilised vaccine, even for one child.

## Summary of Indications and Contraindications to EPI Vaccines

1. Immunize children who are malnourished
2. Immunize pregnant women with Tetanus Toxoid. However, because of the theoretical risk of teratogenicity, avoid giving the vaccine in early pregnancy.
3. Illnesses not requiring hospitalization are not contraindications for vaccination.
4. For children who have an illness requiring hospitalization defer vaccination until the condition of the child improves. Make sure that the child is vaccinated before being discharged. Do not give live vaccines (Yellow fever, Measles) to symptomatic HIV infected children. In HIV asymptomatic children, the measles vaccine should be given at six and nine months of age. Do not give BCG to children who have symptomatic infection with HIV.
5. Do not immunize children who have had a previous severe event (reaction) after a previous dose of the vaccine

Reducing missed opportunities is the cheapest way to increase coverage

If the mother comes and no immunization is due this day, don't be angry, don't send her back. Explain why, tell her when the next immunization is, weigh and provide other services (e.g. check diet, give vitamin A, provide nutritional counselling, etc) for the child or for her) so she doesn't feel she lost her time.

### Planning and Implementing Services with the Community

Health staff should maintain a permanent dialogue and partnership with community leaders and caregivers in order to increase and sustain their support and participation in the immunization program and to enhance their understanding of the importance and timely completion of the vaccination schedule. *Share your achievements with the community: inform people* on how many children you have immunized each month and the number of cases of target diseases that have decreased compared to the previous years. Also communicate programme needs: tracking for pregnant women and newborns, support for ensuring outreach and reducing drop-outs, etc. **Be sure to coordinate with your Community Health Workers and/or Community Health Educator to help dissemination information and communicate with clients and the community.**

Although knowledge per se is insufficient to create demand, poor knowledge about vaccination is a good predictor of poor compliance. Children do not get vaccinated if caregivers do not know the value of vaccines, when children need to be immunized, where vaccines are available, the ap-

appropriate series of vaccines to be followed, or the schedule for immunization. Health workers and Community Health Educators are encouraged to learn what community leaders and caregivers know and feel about the services. The type of information that is communicated and the channels used will vary depending on the audience and the purpose (*e.g.*, informational, managerial, awareness building, educational), the level of knowledge, attitudes and practices, the level of resistance to the adoption of the new behaviour.

Some target groups for advocacy and communication include:

Group	Relevance in immunization	HW consideration
Caregivers	Primary participants to ensure child is vaccinated (parents, relatives, etc)	Ensure effective communication to gain their trust. Provide sufficient information on vaccination program, schedule, safety, side effects, protection
Community and Religious Leaders	Help shape public opinion and can mobilize their communities to support and/or participate in EPI	Advocate, build trust and partner with these leaders to garner their support and participation
Community groups	Influence community members and can mobilize caregivers and foster behavior change and support to EPI	Inform and involve them in immunization activities to identify and track eligible children and target populations (to support activities and prevent left-outs and drop-outs)
Health educators/mobilizers	Assist in planning, implementing and monitoring communication interventions to support EPI. Identify and track target populations, make home visits, follow-up on defaulters.	Ensure that they have basic, factual information on immunization to inform caregivers and communities and that they participate in session preparation and implementation
Immunization staff	Critical information sources on immunization, with public and during vaccination sessions	Ensure that they are motivated, have proper working conditions and materials, use data to make decisions and update programme activities
Private sector and NGOs	Provide services to marginalized and hard to reach populations, where health structures weak. Give technical advice, implement health programmes, monitor and collect data, conduct operational research. Can also pressure local leaders to recognize vaccination as a child right and to provide financing	Solicit their assistance with policy and strategy implementation. Provide them with technical updates and coordinate on planning, monitoring, supervision, identification of bottlenecks and corrective measures, and feedback on results.
Community media	Accessible to often marginalized or underserved populations. Communicate immunization information.	Involve them in immunization information dissemination and liaise with them to plan and implement strategies for reaching underserved.
Local politicians	Support policies/strategies, including ensuring financing and other resources. Advocates in planning and disseminate information.	Advocate with them to ensure sufficient funding and support for immunization plans. Inform them of issues and progress and solicit their involvement to positively promote immunization to the public.

## Role of Community Health Workers

Trained community health workers, health educators, and NGO partners can participate in increasing awareness of preventive services like immunization. They can also assist with tracking individual children and women, participate in outreach, and mobilize households for health sessions. The coverage area for each mobilizer or volunteer should be based on an analysis of the number and location of households that one mobilizer can feasibly reach. The following is a typical list of tasks carried out by community mobilizers:

- Identify target populations in catchment area
- Prepare a list of assigned households with names of infants and mothers (including newborns and pregnant women)
- Share lists of names with health workers to include in vaccination registers
- Make home visits to encourage participation in fixed and outreach sessions
- Help mothers to interpret immunization cards (Mother and Child Health Booklets and women's TT doses)
- Cooperate with the health worker to keep a track of infants and mothers who need to complete the immunization series
- Follow up on defaulters
- Provide information on the session dates and times and vaccination schedules.

## Meeting community needs for an integrated package of interventions

During meetings or discussions with the community it is very likely that they will express needs for other services and interventions besides immunization. The extent to which services are integrated should be appropriate to local health needs and logistical and system capacity (e.g. sufficient trained staff, supplies, equipment, transportation and fuel. This requires organized planning, management and monitoring. Providing a variety of services at fixed sites may be easier than for outreach. The logistical arrangements for providing integrated outreach services may be beyond the capacity of the facility and require the involvement and collaboration of several programmes from national level as well as partners in the districts and communities, notably NGOs. When planning services for the 'hard to reach', health workers should always consider what package of services can be provided during outreach. Community members can assist with organizing outreach sessions, record-keeping and tallying, and/or providing a venue and other support for the health team. Their contributions should be documented and acknowledged.

## Monitoring and use of data

Monitoring of communication process and outcome should be done with other EPI monitoring and data use. Health workers should not only keep their registers, tally sheets, monitoring charts, and other reports up-to-date, but also cross-reference these and review them regularly – with defaulter tracking lists and Community Health Worker activities - to determine where problems may be occurring and how to adjust service delivery and community linkages accordingly. Effective monitoring helps determine: if all hard-to-reach groups are being reached; if appropriate communication channels are being utilized (which channels are most effective at reaching the various participant groups); if communication and outreach services are working (and therefore drop-out is being reduced); the impact of communication interventions on the participant groups' knowledge, attitudes and practices (and use and acceptance of services); the need for and nature of actions to implement for continuous improvement of activities to increase coverage and reduce drop-out. Elicit feedback from the community (e.g. through Dialogue Days, meetings, facility talks) to find out where communication efforts are needed or working well and how to ensure that communities understand, accept and are utilizing the services.

## Communication and Messages

Immunization programmes use many different communication methods to reach parents and other target audiences — for example, radio, television, folk media, community events, and counselling at health facilities. Discussions between health workers and small groups of parents can be held as part of immunization sessions and on other occasions in and outside a health facility to:

- identify and fill information gaps and correct misinformation;
- respond to questions;
- address people's doubts about immunizations;
- reinforce positive attitudes and behaviours.

## Communication Materials

Several complementary materials are usually necessary for providing information on immunization to the different target audiences. Use a mix of the materials listed below for education, promotion or advocacy of the immunization service. Determine which materials are most appropriate for various groups in your community. Plan and budget for these materials in your micro-plan, based on analysis of who will use them, how and by whom they will be distributed, and also dissemination guidelines to determine the quantities needed.

- Question-and-answer sheets.
- Fact sheets about immunization, diseases, and outbreaks.



- Immunization coverage data and success stories (or stories of children who were not vaccinated and became ill from these diseases).
- Leaflets and posters that describe the immunization programme and its services.
- Presentations (video, slides, PowerPoint).
- Journal and newspaper articles and clippings.
- Local radio broadcasts.
- Public announcements, barazas, drama/plays

Traditional sources of communication in villages and communities, such as public announcements in community meeting-places or during events or ceremonies, as well as door-to-door or street-by-street announcements, should be used as much as possible for providing basic information. Local leaders, influencers and volunteers (e.g. community members, Community Health Educators, NGOs), are good resources for conducting these activities.

Drama (e.g. short plays, songs, fables etc.) can be very effective in describing rumours, misconceptions, and other barriers, and then introducing information and strategies to resolve them. Drama should never be used alone however; it should always be a stimulus to a participatory discussion and question-and-answer sessions afterwards. Songs can be used to provide basic information (e.g. number of contacts or ages for receiving vaccinations). Local talent should be consulted to prepare these materials. Ensure that correct information is included in the content of the drama dialogue and songs.

## Communication with the public

### Principles of adult health education

- Be polite and friendly.
- Make sure the mothers are sitting in a comfortable area (or out of the rain or the hot sun).
- Choose one topic per session.
- Tell a story: this helps people to understand e.g. use the success story of polio eradication to convince them that immunization can improve their lives. Request the participation of elderly people who remember polio cases.
- Use a simple language, use “everyday” words.
- Encourage mothers’ participation, ask them to tell their own experiences about diseases and immunization, and encourage them to ask questions.
- Ask “open” questions. That means questions that cannot be answered by yes or no.

- Use teaching materials: handouts, flyers, story books, videos, vaccine vials, slides, etc.

### *Key immunization messages*

The following were identified by KEPI and various studies for basic immunization messages. These should be complemented, however, by more focused messages with communities and caregivers, based on local situational analysis and pre-testing. In addition, when there are periodic campaigns or new vaccine introduction, the messaging will be more specific and targeted.

Immunizations protect a child from several childhood killer diseases. So:

- All children under 12 months need to be vaccinated against these diseases, i.e. TB, whooping cough, diphtheria, tetanus, measles, poliomyelitis, hepatitis B, Hib, pneumonia, rotavirus, yellow fever.
- Children need to get *all* immunizations at the right time *to protect them from these diseases*.
- Immunization prevents death and disability from these diseases.
- An immunized child is a protected child.
- Every healthy child must have an up-to-date immunization card.
- Immunizations are free. You can get them at any health facility.
- Immunizing your children saves time and money.
- Investing in immunization is a priority for Kenya.
- Every child who is due for immunization must be immunized unless severely ill or hospitalized.

### **Tips for communicating with groups**

- Provide a comfortable and welcoming environment for the discussion.
- Ask the group to share what they know about vaccine-preventable diseases and immunization.
- Encourage them to ask questions so that everyone can be better informed. Provide responses aimed at clarifying information and addressing gaps in knowledge.
- Use stories, short plays, songs and visual aids to hold the group's attention and make meetings fun and interesting.
- Involve as many group members as possible in the discussion, and thank them for their input.
- Ask group members to suggest solutions to problems, and discuss the best options.

## *Interpersonal communication*

This face to face communication between health workers and caregivers is important as a primary source of information on immunization. It is most effective, as it allows for interaction and instant feedback. Health workers should practice good interpersonal communication with clients, following the adult health education principles outlined above, as this will determine whether clients understand and accept the services provided and will return to complete all vaccinations.

Before the caregiver leaves, the health workers should establish that they know the following information:

- Which vaccine(s) were administered
- The disease(s) the vaccine(s) protect against. Which side effects may occur and how to address them.
- Importance of having the Mother and Child Health Booklet, understanding its content, and bringing it at every subsequent visit.
- When and where to return for the next visit.
- The importance of immunization to prevent disease.

### **Example of health worker communication skills in practice**

Below is a description of how vaccinators, in ideal circumstances, should interact with caregivers (who are usually, but not always, mothers). This should be adjusted based on the setting (in light of the time available for patient visits, number of people typically waiting for services and other factors). The most essential elements of every immunization encounter are that the vaccinator treats the caregiver with respect, explains when and where to return for the next vaccination, and advises on possible side effects and what to do.

### **The ideal health worker/caregiver interaction:**

1. The health worker welcomes, greets and thanks the caregiver in a friendly manner for coming for vaccination and for her patience if she had to wait.
2. The health worker explains to the caregiver in simple terms and the local language the disease(s) against which the vaccination protects.
3. The health worker mentions possible minor side effects and explains how to handle them.
4. If the child has a common mild illness, the health worker explains that vaccination is still safe and effective and important, and administer it.

5. After the vaccination is given, the health worker writes the date of the current vaccination(s) given on the immunisation card.
6. If the vaccine received is one in a series (e.g. DPT1 or 2, OPV1 or 2; or HepB1 or 2), the health worker explains to the caregiver the need for the child to complete the series to be fully protected against the disease(s). The health worker uses the vaccination chart on the immunisation card as an instructional guide. Where SIAs are conducted, the vaccinator may have to explain that, in addition to the routine doses on the card, all children under age five (or older, depending on the SIA) are urged to get doses during special SIA vaccination days to be even further protected from vaccine-preventable diseases.
7. The health worker writes the date for the next vaccination on the immunisation card and tells the caregiver. If appropriate, the health worker associates the date with a “trigger” such as a holiday or seasonal event that will help the caregiver remember to bring the child back for vaccination. The health worker asks the caretaker to repeat the date, to be certain that it has been understood.
8. The health worker explains to the caregiver that if she and/or the child cannot come on the return date, they can get the next vaccination at another location or another date close to the due date.
9. The health worker reminds the caregiver that she should bring the immunisation card to the location where the child receives the next vaccination.
10. The health worker congratulates the caregiver if the child is fully vaccinated.

11. The health worker asks the caregiver if she has any questions and politely answers all questions.
12. If special supplementary vaccination campaigns are planned in the coming months, the health worker informs the caregiver about the date of campaign, what vaccination is being given, and (if known) where she should bring the child for the supplemental vaccination.
13. For women of child bearing age: The health worker asks the caregiver if she has received her five doses of tetanus toxoid (TT) vaccination and explains the importance of protecting the mother and her future children against tetanus. [If the mother is not sure, the health worker should ask to see the mother's vaccination record.]
14. If vitamin A is being given, the health worker explains to the caregiver that it is important to bring the child back in six months (and give the date) for subsequent vitamin A supplementation to help protect her child from infections.

# ANNEX 1 AEFI REPORT FORM

## (ADAPTED FROM WPRO/EPI/99.01 DOCUMENT)

### 1. Personal Data

Family name: First name: Date of birth:

Sex: Ethnicity: resident /\_\_\_/ Visitor /\_\_\_/ (tick)

Address: District: Province:

### 2. Description of AEFI

#### Please tick:

/\_\_\_/ Toxic shock/Collapse /\_\_\_/ Anaphylaxis /\_\_\_/ High fever? /\_\_\_/ hospitalized

/\_\_\_/ Convulsions /\_\_\_/ Encephalitis/Meningitis• /\_\_\_/ hospitalized

/\_\_\_/ Sepsis• /\_\_\_/ hospitalized

/\_\_\_/ Abscess• /\_\_\_/ sterile or /\_\_\_/ bacterial

/\_\_\_/ Lymphadenitis• /\_\_\_/ >1.5 cm or /\_\_\_/ draining sinus

/\_\_\_/ Severe local reaction• /\_\_\_/ >3 days /\_\_\_/ hospitalized

/\_\_\_/ Vaccine reaction (specify): /\_\_\_/ Other AEFI (specify):

### 3. History and outcome

Past medical history (similar reactions or other allergies. Please specify):

/\_\_\_/ Recovered /\_\_\_/ Hospitalized /\_\_\_/ Died

### 4. Vaccine data

Vaccine/s given      Route   Site      Lot number      Manufacturer      Expiry      date  
and dose number

## 5. Important dates

Date immunized      Date AEFI started      Onset interval      Date of reporting

Health Facility      Name/Title of reporting officer

Date report received      By whom

Proposed action (Please specify):

# ANNEX 2 AEFI CASE INVESTIGATION FORM

## 1. Personal Data

Family name: First name: Date of birth:

Sex: Ethnicity: Resident /\_\_\_/ Visitor /\_\_\_/ (tick)

Guardian's name: Occupation:

Address: District: Province:

## 2. Important dates

Date immunized Date AEFI started Onset interval (days, hours) Date of notification Date of investigation Date of \_\_\_\_\_ of \_\_\_\_\_

## 3. Information on the AEFI

### Please tick:

/\_\_\_/ Toxic shock/Collapse /\_\_\_/ Anaphylaxis /\_\_\_/ High fever? /\_\_\_/ hospitalized

/\_\_\_/ Convulsions /\_\_\_/ Encephalitis/Meningitis? /\_\_\_/ hospitalized

/\_\_\_/ Sepsis? /\_\_\_/ hospitalized

/\_\_\_/ Abscess? /\_\_\_/ sterile or /\_\_\_/ bacterial

/\_\_\_/ Lymphadenitis? /\_\_\_/ >1.5 cm or /\_\_\_/ draining sinus

/\_\_\_/ severe local reaction? /\_\_\_/ >3 days /\_\_\_/ hospitalized

/\_\_\_/ Vaccine reaction (specify):

/\_\_\_/ Other AEFI (specify):

## 4. History and outcome

### Past medical history (similar reactions or other allergies. Please specify):

/\_\_\_/ Treatment given /\_\_\_/ Recovered /\_\_\_/ Hospitalized /\_\_\_/ Died  
/\_\_\_/ Specimen collected • \_\_\_\_\_ Date \_\_\_\_\_ Type \_\_\_\_\_ Sent to \_\_\_\_\_ Date sent

## 5. Suspected vaccine/s and details of diluent



Vaccine/s and given and number dose number	Route	Site date	Lot/batch lot/batch has	Manufacturer Expiry been in use	How long the diluent
--	-------	--------------	----------------------------	------------------------------------	----------------------

6. Name/Title of the health worker who administered vaccine

/\_\_/ Has he/she been trained in EPI? If yes when?

7. Name/title of Investigator Date

# ANNEX 3 AEFI SUMMARY INVESTIGATION FORM (ADAPTED FROM WPRO/EPI/99.01 DOCUMENT)

Complete this summary form at the end of investigation. File with your field report and AEFI reporting form. Submit to your supervisor.

## A. General information

**Date investigation started:**    **Date investigation ended:**

Describe the nature of AEFI:

Suspect vaccine/diluent involved:    Batch number/s:

Diagnosis/case definition of AEFI:

Clinical investigation carried out:    Yes                      No    (tick)

Laboratory investigation carried out:            Yes                      No    (tick)

    If yes, key results:

Community investigation carried out:    Yes                      No    (tick)

If yes:

- **Number** of persons **with AEFIvaccinated** with suspect vaccine
- **Number** of persons having the same (AEFI-like) symptoms but **Not vaccinated** with suspect vaccine

## B. Assessment based on investigation

Conclusion on **cause of AEFI** (tick categories below; rank if more than one cause):

**Programme error**     **Vaccine reaction**     **coincidental**     **Cause Un-**  
**known**

non-sterile injection     vaccine lot problem     similar event

vaccine prepared     known vaccine                      in unimmunised

    Incorrectly                      reaction at expected                      persons

incorrect site or rate  other coincidental

Administration  others events

incorrect vaccine

Transportation/storage

other causes

Please indicate if the above cause you ticked is:  probable  possible  certain

Corrective action taken:  yes  no

If yes, specify nature of action:

Further action recommended:  yes  no

If yes, specify type of action:

Investigator: Title: Date:

# ANNEX 4 AEFI LABORATORY REQUEST FORM

## Personal data

Family name: First name: Date of birth:

Sex: Ethnicity: Resident /\_\_\_/ Visitor /\_\_\_/ (tick)

Guardian's name: Occupation:

Address: District: Province:

## Important dates

Date immunized      Date AEFI started      Date of collection      Date      specimen/s  
of specimen/s sent to laboratory

## Information on samples and tests

Name of the laboratory where specimen/s are being sent:

Precise description of the samples (e.g. ampoules, syringe, stool, pus swab, culture tube etc.):

How are the specimen/s sent (e.g. with dry ice, ice pack, vaccine carrier etc.)

Tests requested:

Suspected vaccine/product involved:

Preliminary clinical diagnosis:

4. Name of person to whom laboratory results should be sent:

5. His/her complete address, telephone/e-mail numbers

6. Referring Health Facility:

7. Name /title of person sending the samples for laboratory examination:

8. Date

# ANNEX 5 NATIONAL CHILD IMMUNIZATION SCHEDULE

	Vaccine dose	Age of child	Dosage	Route
1	BCG OPV birth dose (trivalent)	At birth or at first contact  At birth or at first contact (within the first two weeks of life)	<ul style="list-style-type: none"> <li>• 0.05 ml</li> <li>• 2 drops</li> </ul>	<ul style="list-style-type: none"> <li>• Intradermal</li> <li>• Oral</li> </ul>
2	OPV I DPT-HepB+Hib 1  PCV10 - 1	At six weeks of life or at first contact	<ul style="list-style-type: none"> <li>• 2 drops</li> <li>• 0.5ml</li> <li>• 0.5ml</li> </ul>	<ul style="list-style-type: none"> <li>• Oral</li> <li>• Intramuscular into the upper outer aspect of the left thigh</li> <li>• Intramuscular into the upper outer aspect of the right thigh</li> </ul>
3	OPV II DPT-HepB+Hib 2  PCV10 - 2	At 10 weeks or 4 weeks after OPV I and DPT-HepB-Hib 1	<ul style="list-style-type: none"> <li>• 2 drops</li> <li>• 0.5 ml</li> <li>• 0.5ml</li> </ul>	<ul style="list-style-type: none"> <li>• Oral</li> <li>• Intramuscular into the upper outer aspect of the left thigh</li> <li>• Intramuscular into the upper outer aspect of the right thigh</li> </ul>
4	OPV III DPT-HepB+Hib 3  PCV10 - 3	At 14 weeks or 4 weeks after OPV II and DPT-HepB-Hib 2	<ul style="list-style-type: none"> <li>• 2 drops</li> <li>• 0.5 ml</li> <li>• 0.5ml</li> </ul>	<ul style="list-style-type: none"> <li>• Oral</li> <li>• Intramuscular into the upper outer aspect of the left thigh</li> <li>• Intramuscular into the upper outer aspect of the right thigh</li> </ul>
5.	Vitamin A 100,000IU	At 6 months of age	One capsule	Orally
6	Measles 1 <sup>st</sup> dose	At 9 months or first contact after 9 months	0.5 ml	Subcutaneous into the right upper arm (deltoid muscle)
7	Yellow fever	At 9 months or first contact after 9 months – in four special districts	0.5 ml	Subcutaneous into the left upper arm (deltoid muscle)
8.	Vitamin A 200,000IU	At 12 months of age	One capsule	Orally
9	Measles 2 <sup>nd</sup> dose	At 18 months or first contact after 18 months	0.5 ml	Subcutaneous into the right upper arm (deltoid muscle)
10.	Vitamin A 200,000IU	At 18 months of age	One capsule	Orally

